

AMGP-6445

40.5 – 43.5 GHz SMT Packaged Linear Power Amplifier



Data Sheet



Description

The AMGP-6445 is a linear power amplifier in a surface mount package designed for use in transmitters that operate at frequencies between 40.5 GHz and 43.5 GHz. In the operational frequency band, it provides 27dBm of output power (P-1 dB) and 19 dB of small-signal gain. This PA is designed for high linearity applications, and the PA shows more than +31 dBm OIP3 at 18 dBm/tone output power.

Functional Block Diagram

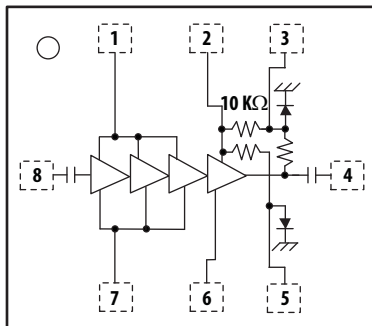

Pin	Function
1	Vd1
2	Vd2
3	DET_O
4	RF_OUT
5	DET_R
6	Vg2
7	Vg1
8	RF_IN

Features

- 5 x 5 mm surface mount package
- RF frequency range from 40.5 to 43.5 GHz
- Gain: 19 dB Typical
- Output P1dB : +27.5 dBm Typical
- Output IP3: +31 dBm Typical
- 50 Ω Input and Output Match
- ESD protection all ports above 50 V MM and 250 V HBM
- Integrated temperature compensated power detector
- Vdd/Id: 5 V/700 mA
- 40° C to +85° C operation

Application

- Microwave Radio Systems

Package Diagram

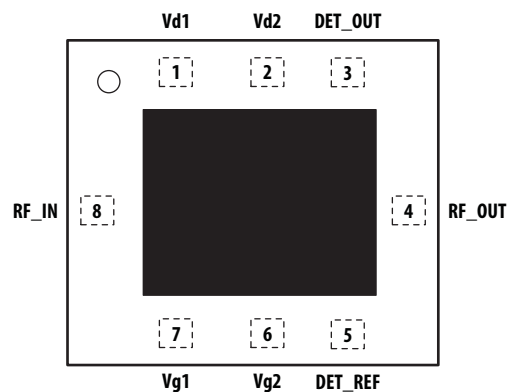



Attention: Observe Precautions for handling electrostatic sensitive devices.
ESD Machine Model: 50V
ESD Human Body Model: 250V
Refer to Avago Application Note A004R:
Electrostatic Discharge Damage and Control.

Note: MSL Rating = Level 2A

ELECTRICAL SPECIFICATIONS

Table 1. Absolute Minimum and Maximum Ratings

Parameter Description	Specifications				Comments
	Min.	Max.	Unit		
Drain Supply Voltage	Vd1		5.5	V	
	Vd2				
Gate Voltage	Vg1	-2	0	V	
	Vg2				
Total Gate Current	Ig1		-3	mA	I _{g, total} = I _{g1} + I _{g2} I _{g, total} occurs at highest RF Pout condition.
	Ig2				
RF Input Power (Pin)	RFIN		20	dBm	CW
Power Dissipation (Pd)			4	W	$P_d = V_{d1} \times I_{d1} + V_{d2} \times I_{d2} + P_{in} - P_{out}$
Channel Temperature			150	°C	
Storage Temperature		-65	150	°C	

Table 2. Recommended Operating Range

Parameter Description	Pin	Specifications			Unit	Comments
		Min.	Typical	Max.		
Drain Supply Voltage	Vd1		4.7 [1]		V	
	Vd2		4.4			
Gate Supply Voltage	Vg1	-0.83	-0.63	-0.43	V	
	Vg2					
Quiescent Drain Supply Current (Idq)	Vd1		200 [2]		mA	I _{dq} = I _{d1} + I _{d2}
	Vd2		560			
RF Output Power (Pout)	RFOUT		28	30	dBm	CW
Frequency Range		40.5		43.5	GHz	
Thermal Resistance, θ_{ch-b}			13		°C/W	Channel to board
Case Temperature		-40		+85	°C	
ESD	Human Body Model		250		V	
	Machine Model		50		V	

Notes:

1. Not recommend to operate below that this voltage level; otherwise, the amplifier may enter instability.
2. Not recommend to operate above that this current level; otherwise, the amplifier may enter instability.

Table 3. RF Electrical Characteristics^[1]

All data measured on a 2.4mm connector based evaluation board at Vdd1 = Vdd2 = 5 V (pulse), Idq = 0.7 A (Id1 + Id2), T_C = 25° C, and 50 Ω at all ports.

Parameter	Performance			Unit	Comments
	Min.	Typical	Max.		
Input Return Loss (S11)		-8		dB	
Output Return Loss (S22)		-8		dB	
Gain (S21)	Freq = 40.5 GHz Freq = 42 GHz Freq = 43.5 GHz	18	22.9 21.1 22.5	dBm	Freq = 40.5, 42, 43.5 GHz
Reverse Isolation (S21)			-40	dB	
P1dB	Freq = 40.5 GHz Freq = 42 GHz Freq = 43.5 GHz	27	28.9 27.9 29.8	dBm	Freq = 40.5, 42, 43.5 GHz
IM3 Level			-23	dBc	Δf = 20 MHz, Po = 18 dBm/tone
Detector sensitivity			2.4	V/W	

Note:

- Gain and P1dB measurement accuracy is subjected to the tolerance of ± 0.5 dB, ± 0.5 dBm respectively.

**Product Consistency Distribution Charts at 40.5 GHz, 42 GHz and 43.5 GHz, Vdd = 5.5 V, Id = 0.7 A
(Sample Size of 1500 pieces)**

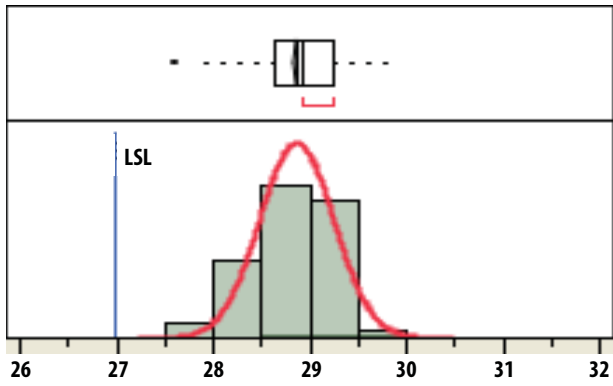

P1dB @ 40.5 GHz, Mean = 28.9 dBm, LSL = 27 dBm

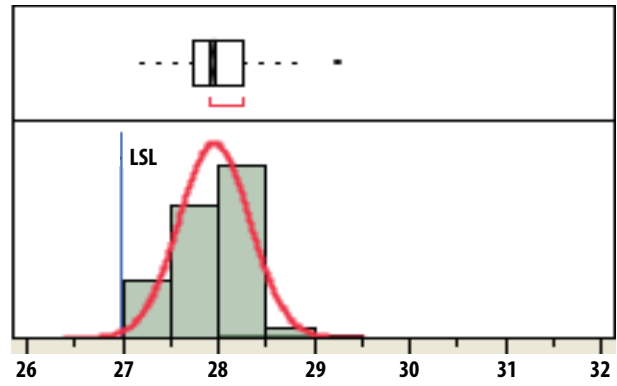

P1dB @ 42 GHz, Mean = 27.9 dBm, LSL = 27 dBm

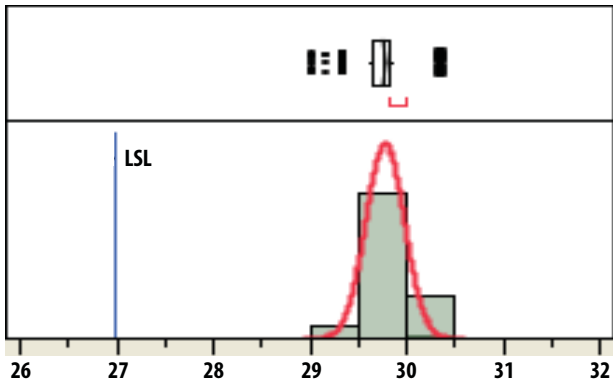

P1dB @ 43.5 GHz, Mean = 29.8 dBm, LSL = 27 dBm

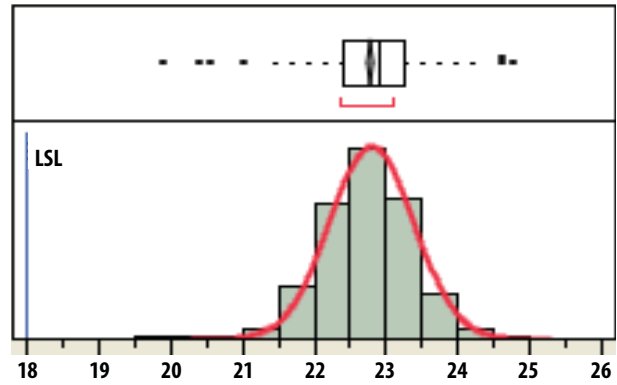

Gain @ 40.5 GHz, Mean = 22.9 dB, LSL = 18 dB

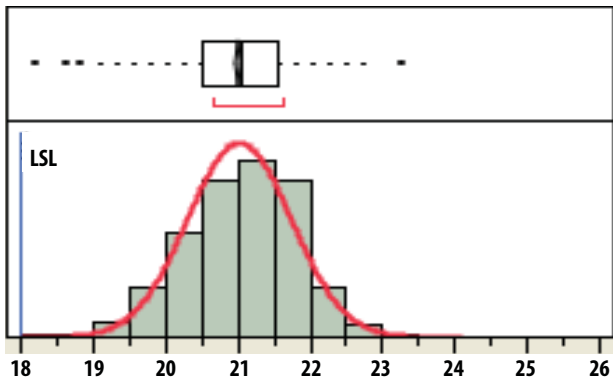

Gain @ 42 GHz, Mean = 21.1 dB, LSL = 18 dB

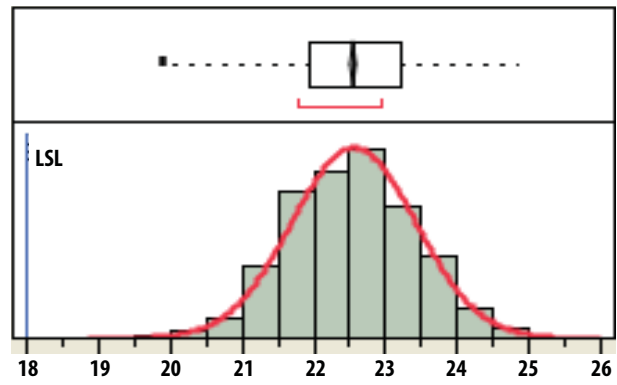

Gain @ 43.5 GHz, Mean = 22.5 dB, LSL = 18 dB

Selected performance plots

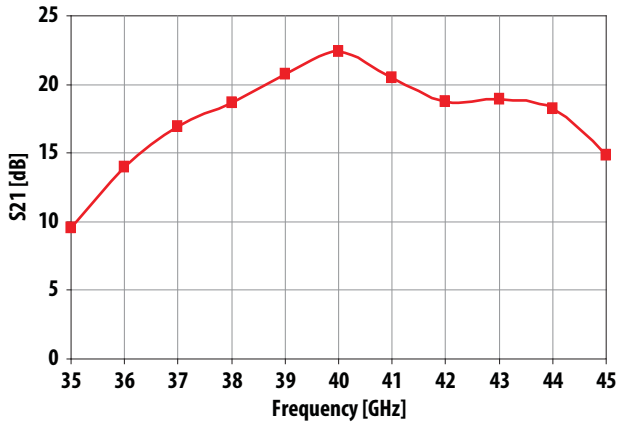

Figure 1. S21(dB) Frequency Sweep

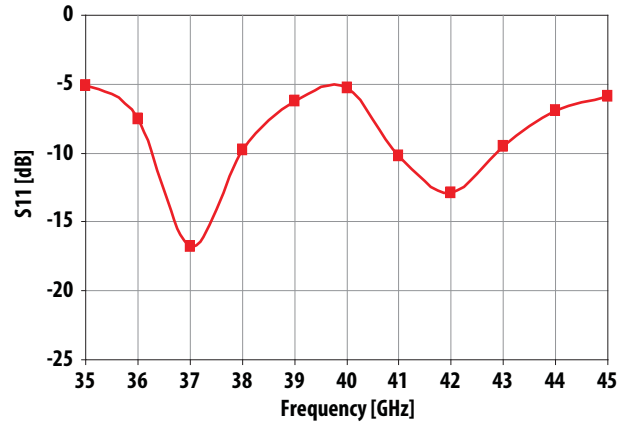

Figure 2. S11(dB) Frequency Sweep

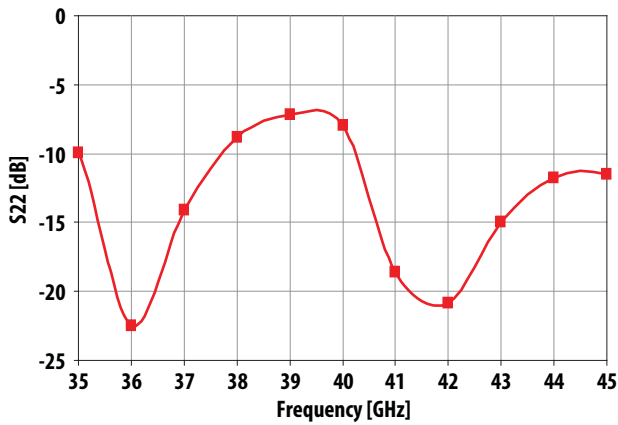

Figure 3. S22(dB) Frequency sweep

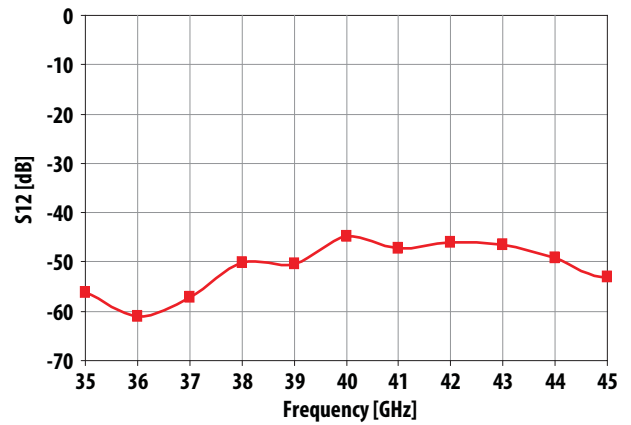

Figure 4. S12(dB) Frequency Sweep

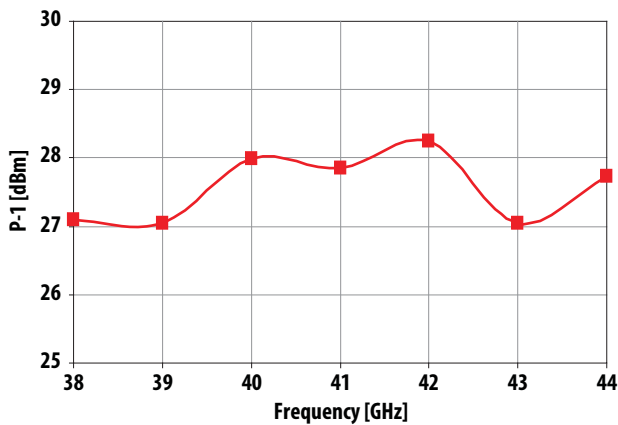

Figure 5. P-1(dBm) Frequency Sweep

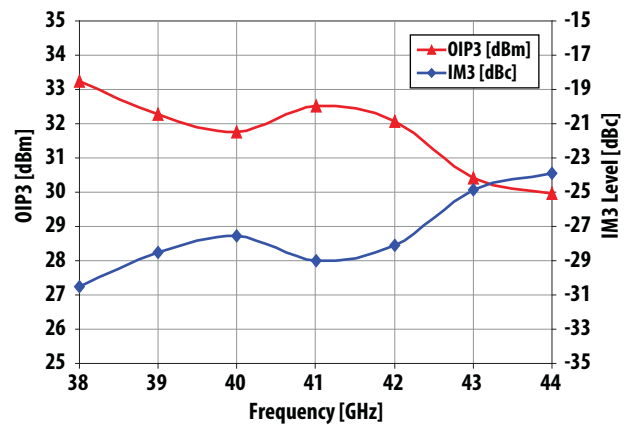

Figure 6. OIP3(dBm) Frequency Sweep at Po=18dBm/tone

Selected Over Temperature Performance Plots

All data measured on a 2.4 mm connector based evaluation board at $V_{dd1} = V_{dd2} = 5\text{ V}$, $I_{dq} = 0.7\text{ A}$ ($I_{d1} + I_{d2}$), and $50\ \Omega$ at all ports. I_{dq} has been maintained at 700 mA under different temperature conditions.

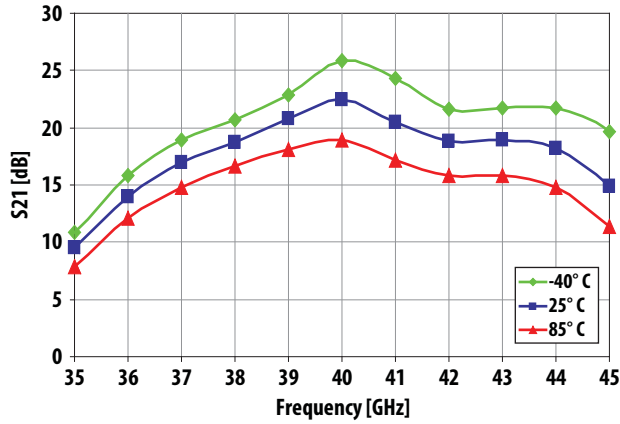

Figure 7. S21(dB) Frequency Sweep over Temperature

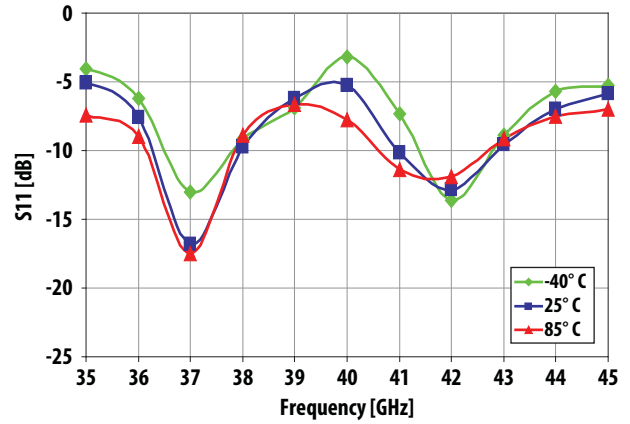

Figure 8. S11(dB) Frequency Sweep over Temperature

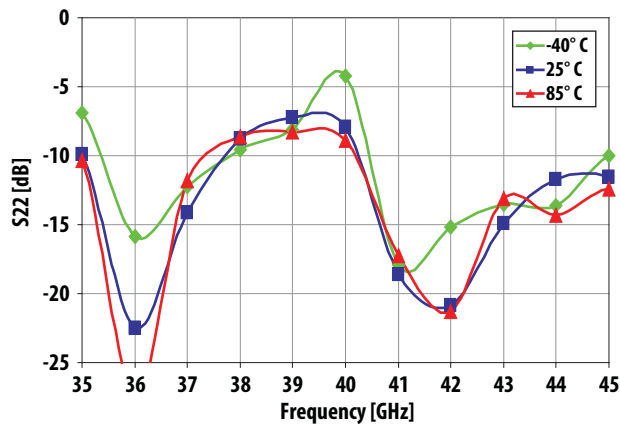

Figure 9. S22(dB) Frequency Sweep over Temperature

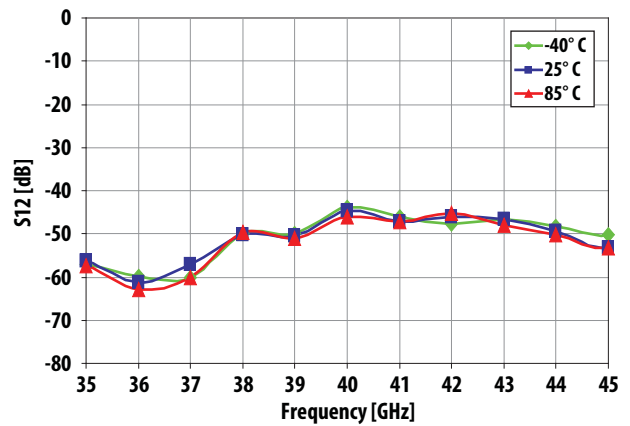

Figure 10. S12(dB) Frequency Sweep over Temperature

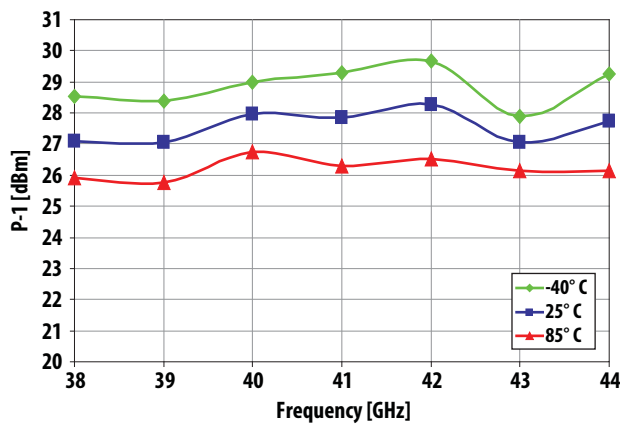

Figure 11. P-1(dBm) Frequency Sweep over Temperature

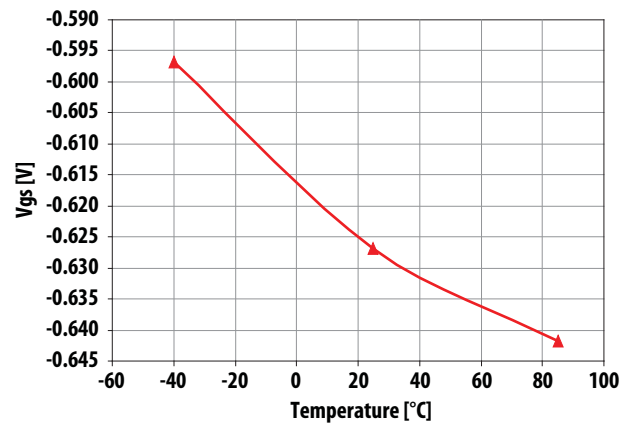

Figure 12. Typical V_g to obtain $I_{dq} = 700\text{ mA}$ over Temperature

Detector Performance Plots

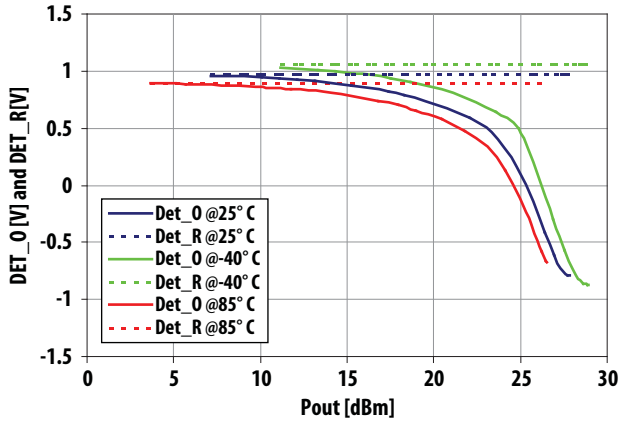

Figure 13. Detector voltages vs. Output Power at Freq = 40 GHz

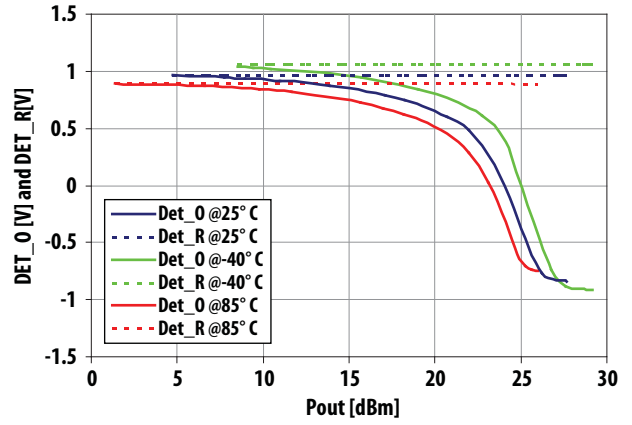

Figure 14. Detector voltages vs. Output Power at Freq = 41 GHz

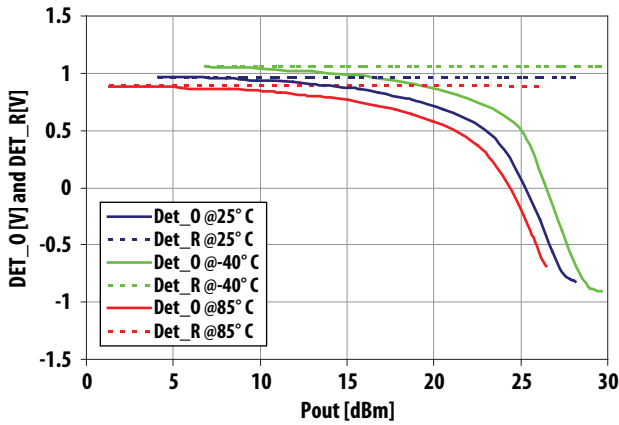

Figure 15. Detector voltages vs. Output Power at Freq = 42 GHz

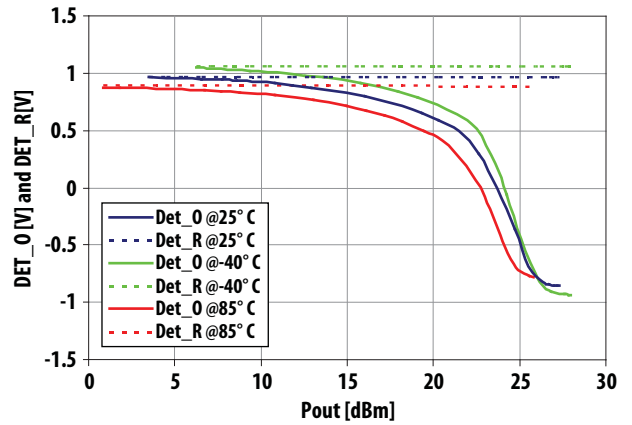

Figure 16. Detector voltages vs. Output Power at Freq = 43 GHz

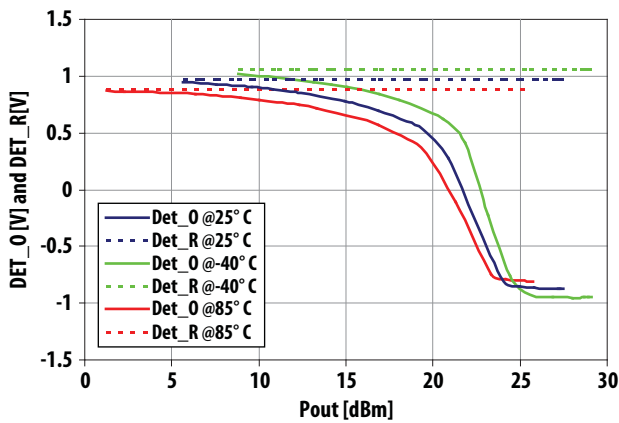

Figure 17. Detector voltages vs. Output Power at Freq = 44 GHz

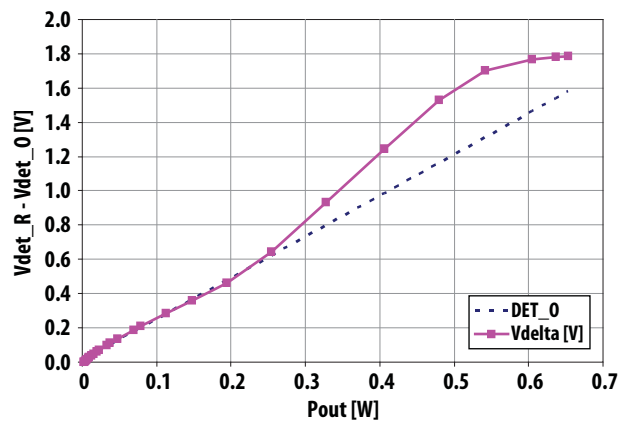
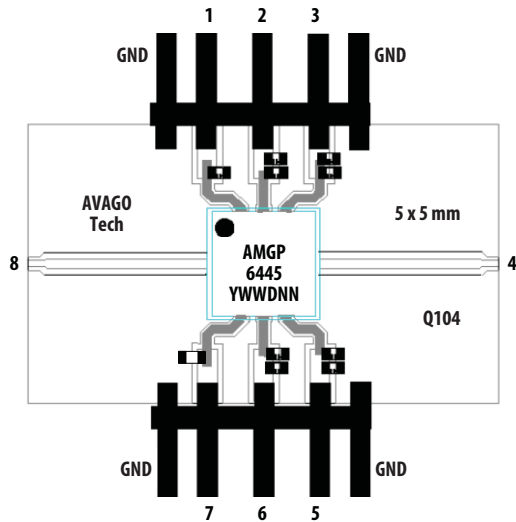

Figure 18. Typical detector sensitivity vs. Output Power at Freq = 42 GHz

Evaluation Board Description



Recommended turn on sequence

- Apply V_{g1} and V_{g2} at -1.5 V
- Apply V_{d1} and V_{d2} at 0 V
- Increase V_d to 5 V
- Increase V_g of -1.5 V to approximately -0.6 V to obtain $I_{dsq} = 0.7$ A
- Apply RF Input not to exceed 20 dBm

Turn off in reverse order

Table 4. Typical Test Conditions

Pin		
$V_{d1,2}$	5 V	Drain Supply Voltage
$I_{dq} = I_{d1} + I_{d2}$	700 mA	Quiescent Drain Current
$V_{g1, 2}$	-0.6	Gate Supply Voltage

Notes:

V_{g1} and V_{g2} of -0.6 V may need be adjusted to obtain $I_{dsq} = 700$ mA.

Demo board circuit

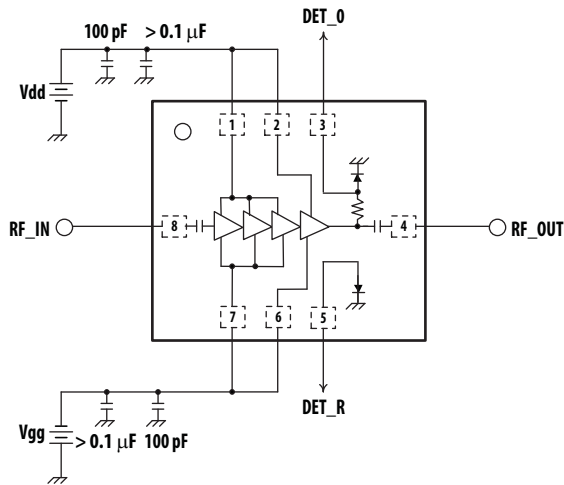

Figure 19.

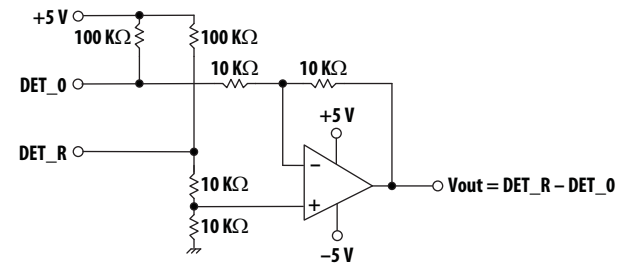

Figure 20.

Integrated Detector Application Circuit

To obtain temperature compensated RF power detector function, a differential voltage between DET_R and DET_O must be obtained by using an operational amplifier in a differential mode configuration as shown in Figure 19.

Package Dimension, PCB Layout and Tape and Reel information

Please refer to Avago Technologies Application Note 5521, AMxP-xxxx production Assembly Process (Land Pattern B).

Part Number Ordering Information

Part Number	Devices per Container	Container
AMGP-6445-BLKG	10	antistatic bag
AMGP-6445-TR1G	100	7" Reel
AMGP-6445-TR2G	500	7" Reel

For product information and a complete list of distributors, please go to our web site: www.avagotech.com

Avago, Avago Technologies, and the A logo are trademarks of Avago Technologies in the United States and other countries. Data subject to change. Copyright © 2005–2012 Avago Technologies. All rights reserved.
AV02-3210EN - May 10, 2012

