

AMMC-6431

25-33 GHz 0.7W Power Amplifier MMIC



Data Sheet

Description

The AMMC-6431 is an MMIC power amplifier designed for use in wireless transmitters that operate within a 25GHz and 33GHz range. At 32GHz, it provides 28.5dBm of output power⁽¹⁾ and 19.5dB of small-signal gain from a small easy-to-use device. This MMIC is optimized for linear operation with an output third order intercept point (OIP3) of 37dBm. The device has input and output matching circuitry for use in 50Ω environments. The AMMC-6431 also has integrated, temperature compensated RF power detection circuitry that enables power detection of 0.3V/Watt at 30GHz.

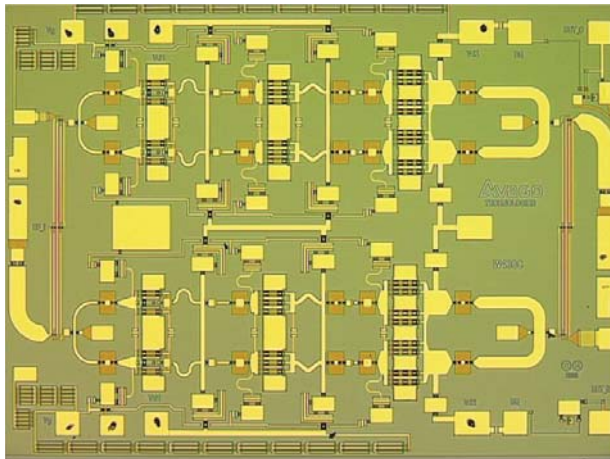

Chip Size: 2500 x 1870 μm (100 x 74 mils)
Chip Size Tolerance: ± 10 μm (± 0.4 mils)
Chip Thickness: 100 ± 10 μm (4 ± 0.4 mils)
Pad Dimensions: 100 x 100 μm (4 x 4 ± 0.4 mils)

Features

- MMIC bare die
- 0.7 watt output power (P-1)
- 50 Ω match on input and output

Typical Performance (Vd=5V, Idsq=0.65A)

- Frequency range 25 to 33 GHz
- Small signal Gain of 19dB
- Output power @ P-1 of 28.5dBm (Typ.)
- Input/Output return-loss of -15dB/-15dB

Applications

- Microwave Radio systems
- Satellite VSAT, Up/Down Link
- LMDS & Pt-Pt mmW Long Haul
- WLL and MMDS loops

Note:

1. This MMIC uses depletion mode pHEMT devices. Negative supply is used for DC gate biasing.



Attention: Observe Precautions for handling electrostatic sensitive devices.

Vdd and Vgg Pins: ESD Machine Model (Class A): 50V

Vdd and Vgg Pins: ESD Human Body Model (Class 0): 150V

Detector Pins: ESD Machine Model <20V

Detector Pins: ESD Human Body Model <60V

Refer to Avago Application Notes A004R

Electrostatic Discharge Damage and

Control Refer to Avago Application Note

A004R:

Electrostatic Discharge Damage and Control.

Table 1. Absolute Maximum Ratings^[1,2,3,4, and 5]

Symbol	Parameters	Unit	Max	Notes
V _d -V _g	Drain to Gate Voltage	V	8	
V _d	Positive Supply Voltage ^[2]	V	5.5	2
V _g	Gate Supply Voltage	V	-2.5 to 0.5	
I _d	Drain Current ^[2]	A	1.1	2,3
P _D	Power Dissipation ^[2,3]	W	3.85	2,3
P _{in}	CW Input Power ^[2]	dBm	15.5	2
T _{ch}	Operating Channel Temp. ^[4,5]	°C	+150	4,5
T _{stg}	Storage Case Temp.	°C	-65 to +150	
T _{max}	Maximum Assembly Temp (30 sec max)	°C	+300	

Notes:

1. Operation in excess of any one of these conditions may result in permanent damage to this device. Functional operation at or near these limitations will change to may significantly reduce the lifetime of the device.
2. Combinations of supply voltage, drain current, input power, and output power shall not exceed P_D.
3. When operated at this condition with a base plate temperature of 85°C, the median time to failure (MTTF) is significantly reduced.
4. These ratings apply to each individual FET.
5. The operating channel temperature will directly affect the device MTTF. For maximum life, it is recommended that junction temperatures be maintained at the lowest possible levels.

Table 2. DC Specifications/ Physical Properties^[1]

Symbol	Parameters and Test Conditions	Units	
I _d	Drain Supply Current (V _d = 5 V, V _g set for I _d Typical)	mA	650
V _g	Gate Supply Operating Voltage (I _{d(Q)} = 650 (mA))	V	-1.0
I _g	Gate Supply Current (V _g = -1V set for I _d Typical)	mA	-0.10
Rθ _{jc}	Thermal Resistance ^[6] (Channel-to-Backside)	°C/W	16.8

Note:

1. Assume conductive epoxy attachment to an evaluation RF board at 85°C base plate temperatures.

Table 3. Thermal Properties

Parameter	Test Conditions	Value
Maximum Power Dissipation	T _{baseplate} = 85°C	P _D = 3.85W T _{channel} = 150°C
Thermal Resistance (θ _{jc})	V _d = 5V I _d = 650mA P _D = 3.25W T _{baseplate} = 85°C	θ _{jc} = 16.8°C/W T _{channel} = 139.6°C
Thermal Resistance (θ _{jc}) Under RF Drive	V _d = 5V I _d = 790mA P _{out} = 24dBm P _d = 3.7W T _{baseplate} = 85°C	θ _{jc} = 16.8°C/W T _{channel} = 147.14°C

Table 4. RF Specifications^[1 and 2]

$T_A = 25^\circ\text{C}$, $V_d = 5\text{ V}$, $I_{d(Q)} = 650\text{ mA}$, $Z_o = 50\ \Omega$

Symbol	Parameters and Test Conditions	Units	Minimum	Typical	Maximum
Freq	Operational Frequency	GHz	25		33
Gain	Small-signal Gain ^[3]	dB	16.5	19	
P _{-1dB}	Output Power at 1dB Gain Compression ^[3]	dBm	26.5	28.5	
OIP3	Output Third Order Intercept Point ^[4]	dBm		38	
RL _{in}	Input Return Loss	dB		-15	
RL _{out}	Output Return Loss	dB		-15	
Isolation	Reverse Isolation	dB		43	

Notes:

1. Small/Large -signal data measured in on-wafer environment at $T_A = 25^\circ\text{C}$.
2. This die part performance is verified by a functional test correlated to actual performance at one or more frequencies.
3. Performance verified 100% on-wafer for published specifications at Frequencies=27, 29.5, and 32GHz.
4. OIP3 data is at -20dBm, SCL (SCL=single carrier level).

**Typical distribution of Small Signal Gain and Output Power@P-1dB.
Based on 1500 part sampled over several production lots.**

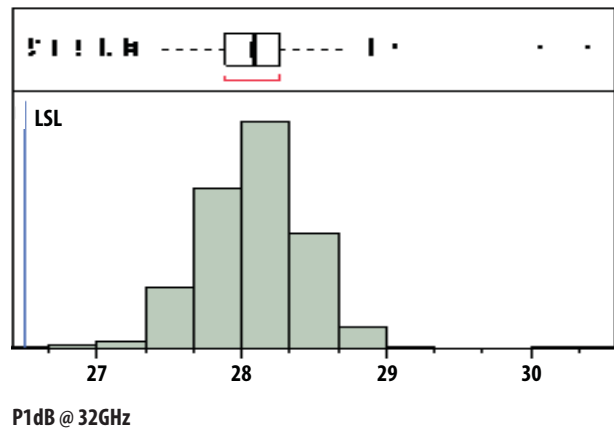
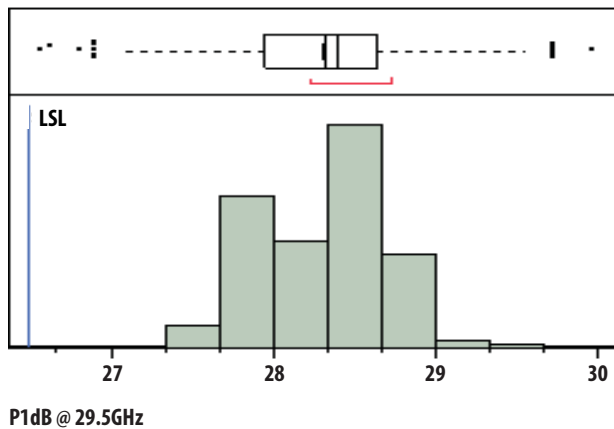
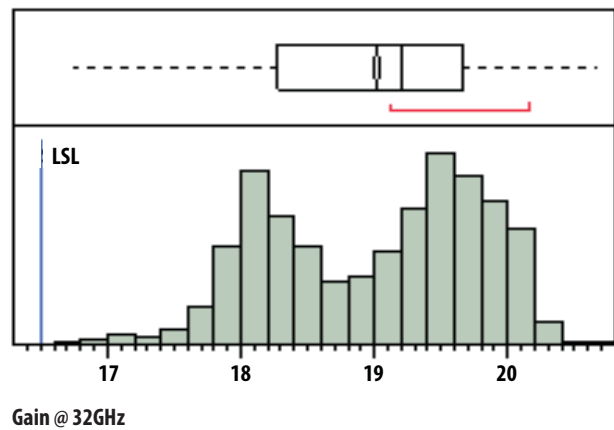
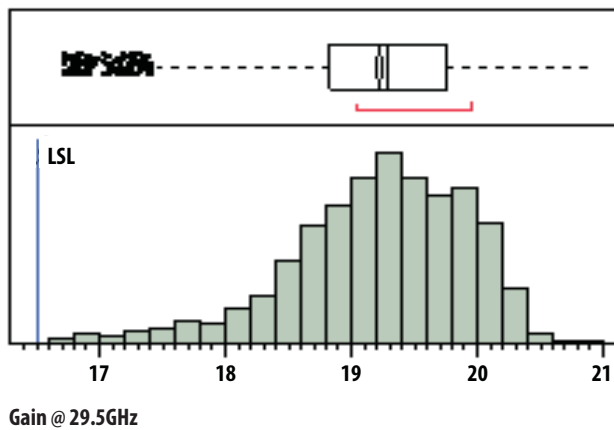

Typical Performances (Data obtained from on-wafer environment.)

($T_A = 25^\circ\text{C}$, $V_d = 5\text{ V}$, $I_{d(Q)} = 650\text{ mA}$, $Z_{in} = Z_{out} = 50\ \Omega$)

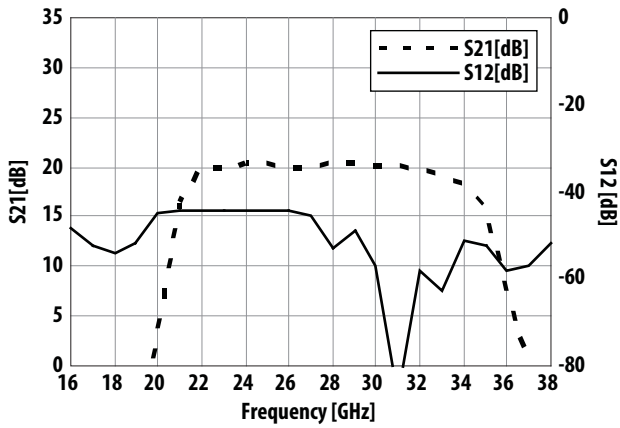

Figure 1. Typical Gain and Reverse Isolation

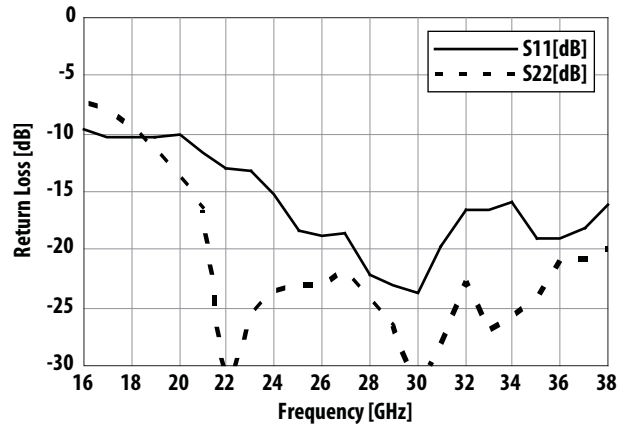

Figure 2. Typical Return Loss (Input and Output)

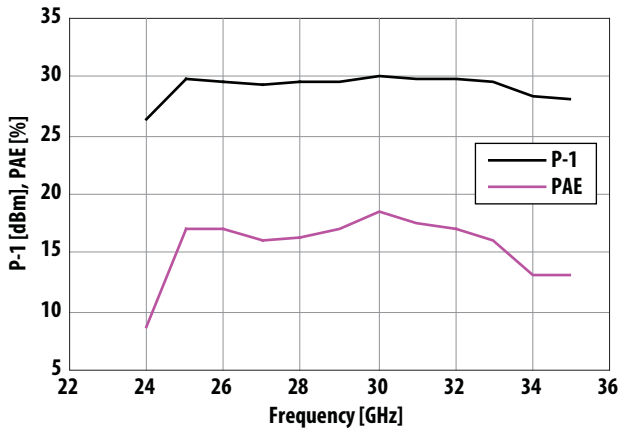

Figure 3. Typical Output Power (@P-1) and PAE and Frequency

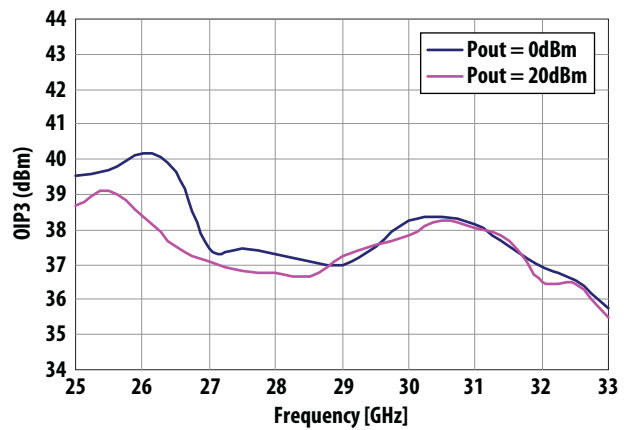

Figure 4. Typical OIP3 level

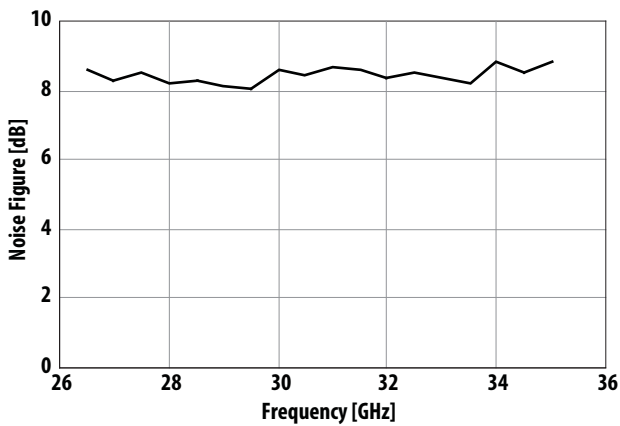

Figure 5. Typical Noise Figure

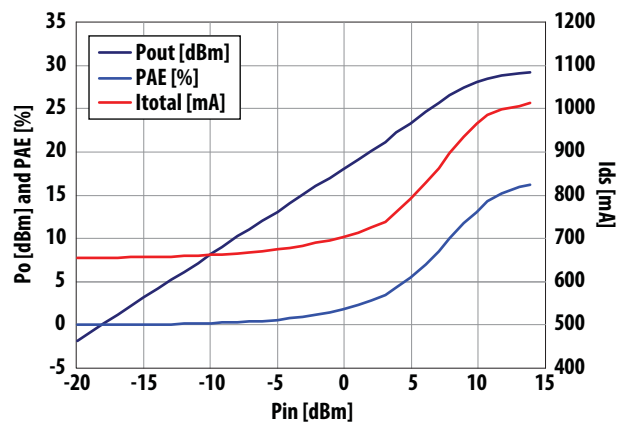

Figure 6. Typical Output Power, PAE, and Total Drain Current versus Input Power at 30GHz

Typical over temperature dependencies

($T_A = 25^\circ\text{C}$, $V_d = 5\text{ V}$, $I_{d(Q)} = 650\text{ mA}$, $Z_{in} = Z_{out} = 50\ \Omega$)

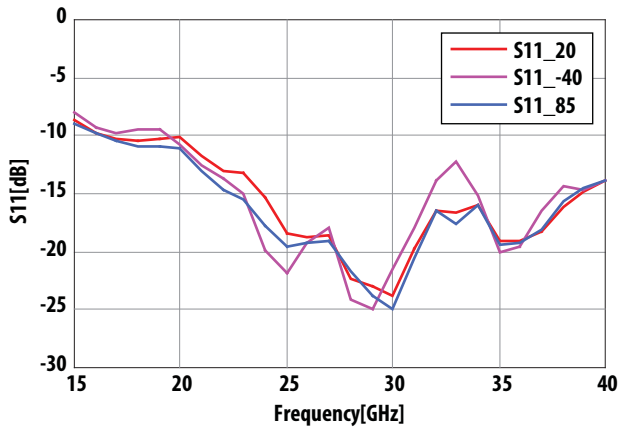

Figure 7. Typical S11 over temperature

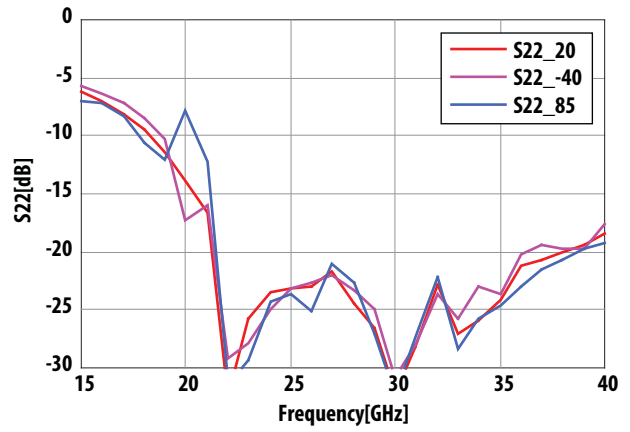

Figure 8. Typical S22 over temperature

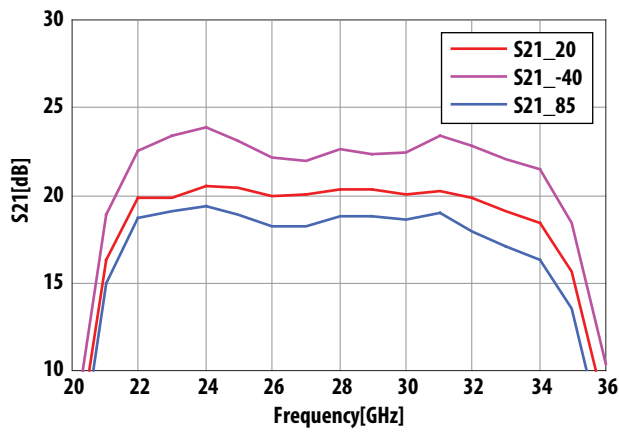

Figure 9. Typical Gain over temperature

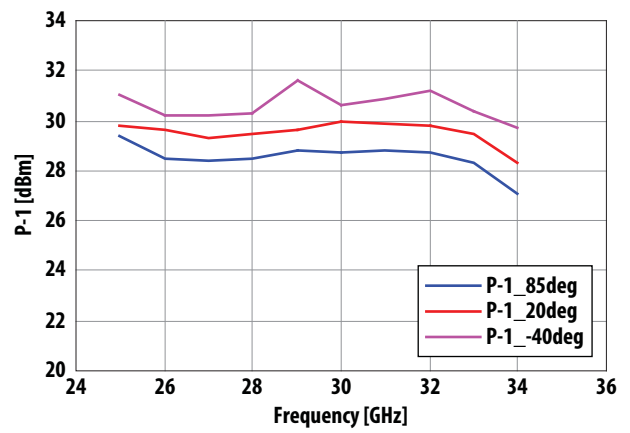

Figure 10. Typical P-1 over temperature

Typical Scattering Parameters [1], ($T_A = 25^\circ\text{C}$, $V_d = 5\text{ V}$, $I_D = 650\text{ mA}$, $Z_{in} = Z_{out} = 50\ \Omega$)

Freq [GHz]	S11			S21			S12			S22		
	dB	Mag	Phase	dB	Mag	Phase	dB	Mag	Phase	dB	Mag	Phase
1	-0.077	0.991	-19.983	-60.469	0.001	166.900	-81.687	8.23E-05	24.252	-0.074	0.991	-20.313
2	-0.241	0.973	-39.738	-52.171	0.002	29.031	-80.019	9.98E-05	20.000	-0.216	0.975	-40.426
3	-0.498	0.944	-59.315	-55.142	0.002	-146.570	-78.899	1.14E-04	6.003	-0.441	0.950	-60.579
4	-0.833	0.909	-78.697	-62.938	0.001	178.230	-74.112	1.97E-04	-36.218	-0.823	0.910	-80.666
5	-1.237	0.867	-98.141	-43.985	0.006	126.660	-66.675	4.64E-04	-35.182	-1.410	0.850	-98.359
6	-1.746	0.818	-117.380	-43.412	0.007	10.664	-62.140	7.82E-04	-75.622	-1.515	0.840	-116.700
7	-2.360	0.762	-136.120	-48.035	0.004	-60.842	-59.696	1.04E-03	-97.389	-1.941	0.800	-136.370
8	-3.039	0.705	-154.410	-51.240	0.003	-103.580	-59.173	1.10E-03	-118.910	-2.469	0.753	-155.370
9	-3.766	0.648	-172.360	-48.513	0.004	-131.770	-51.928	2.53E-03	-130.540	-3.090	0.701	-174.530
10	-4.607	0.588	170.480	-47.266	0.004	-164.700	-49.871	3.21E-03	-170.850	-3.836	0.643	167.050
11	-5.397	0.537	154.340	-46.308	0.005	161.440	-47.339	4.30E-03	157.920	-4.612	0.588	149.050
12	-6.171	0.491	138.450	-48.989	0.004	151.040	-48.209	3.89E-03	134.960	-5.744	0.516	131.740
13	-6.956	0.449	122.880	-42.928	0.007	126.960	-47.143	4.39E-03	114.220	-5.202	0.549	120.390
14	-7.810	0.407	108.020	-48.693	0.004	105.440	-49.530	3.34E-03	93.908	-5.506	0.531	94.598
15	-8.704	0.367	94.034	-48.293	0.004	99.109	-46.836	4.55E-03	84.854	-6.244	0.487	71.552
16	-9.731	0.326	82.601	-50.088	0.003	-104.870	-48.380	3.81E-03	57.598	-7.079	0.443	48.181
17	-10.273	0.306	72.437	-31.237	0.027	-137.630	-52.638	2.33E-03	49.368	-8.116	0.393	23.872
18	-10.357	0.304	63.398	-19.176	0.110	-175.960	-53.930	2.01E-03	59.174	-9.493	0.335	-1.088
19	-10.326	0.305	49.648	-8.225	0.388	140.180	-52.049	2.50E-03	105.370	-11.415	0.269	-26.586
20	-10.136	0.311	33.243	3.185	1.443	86.436	-45.077	5.57E-03	81.808	-13.848	0.203	-49.739
21	-11.726	0.259	5.689	16.279	6.515	-0.766	-44.444	5.99E-03	48.349	-16.613	0.148	-89.859
22	-13.008	0.224	12.082	19.830	9.806	-125.960	-44.231	6.14E-03	26.188	-32.492	0.024	-50.262
23	-13.181	0.219	-8.121	19.857	9.837	151.340	-44.322	6.08E-03	20.131	-25.749	0.052	-27.237
24	-15.306	0.172	-25.755	20.492	10.583	76.402	-44.166	6.19E-03	4.351	-23.416	0.067	-25.746
25	-18.467	0.119	-30.815	20.429	10.507	5.230	-44.361	6.05E-03	-22.443	-23.120	0.070	-42.304
26	-18.762	0.115	-33.500	19.944	9.935	-58.272	-44.287	6.10E-03	-38.251	-23.052	0.070	-52.063
27	-18.660	0.117	-61.890	20.006	10.007	-117.520	-45.367	5.39E-03	-61.764	-21.753	0.082	-77.146
28	-22.267	0.077	-117.260	20.289	10.339	-179.600	-52.699	2.32E-03	-100.710	-24.444	0.060	-124.880
29	-22.969	0.071	171.100	20.334	10.392	118.090	-48.914	3.58E-03	-115.080	-26.543	0.047	-169.590
30	-23.831	0.064	120.740	20.086	10.099	56.810	-57.196	1.38E-03	-13.026	-32.149	0.025	163.930
31	-19.696	0.104	89.485	20.264	10.308	-7.301	-86.390	4.79E-05	-110.990	-28.208	0.039	98.822
32	-16.540	0.149	63.017	19.844	9.822	-76.664	-58.316	1.21E-03	-90.101	-22.788	0.073	43.097
33	-16.563	0.149	48.425	19.061	8.975	-146.840	-62.456	7.54E-04	95.297	-27.046	0.044	34.450
34	-15.997	0.159	24.956	18.455	8.371	138.600	-51.473	2.67E-03	9.766	-25.843	0.051	3.390
35	-19.102	0.111	32.406	15.610	6.032	41.331	-52.271	2.43E-03	-89.155	-24.164	0.062	87.149
36	-19.030	0.112	33.056	7.590	2.396	-37.977	-58.079	1.25E-03	-10.631	-21.121	0.088	50.148
37	-18.208	0.123	41.791	-0.282	0.968	-93.034	-56.887	1.43E-03	-75.956	-20.734	0.092	39.272
38	-16.155	0.156	41.383	-7.118	0.441	-137.930	-51.862	2.55E-03	-93.972	-20.036	0.100	35.813
39	-14.844	0.181	37.673	-13.083	0.222	-177.500	-55.895	1.60E-03	-172.160	-19.445	0.107	34.941
40	-13.854	0.203	31.156	-18.381	0.121	145.120	-54.466	1.89E-03	174.220	-18.439	0.120	32.269
41	-13.279	0.217	25.134	-23.418	0.067	108.210	-55.882	1.61E-03	95.966	-17.974	0.126	30.033
42	-12.333	0.242	18.900	-28.368	0.038	74.030	-56.424	1.51E-03	18.169	-17.423	0.135	29.772
43	-12.299	0.243	8.532	-33.116	0.022	44.005	-63.055	7.04E-04	-19.621	-16.490	0.150	31.789
44	-12.639	0.233	5.682	-37.361	0.014	15.287	-67.840	4.06E-04	18.665	-14.952	0.179	30.441
45	-12.607	0.234	1.261	-42.047	0.008	-7.198	-59.332	1.08E-03	108.870	-13.914	0.202	24.723
46	-12.833	0.228	-3.995	-48.137	0.004	-41.587	-64.602	5.89E-04	144.820	-13.287	0.217	16.249
47	-13.609	0.209	-10.378	-47.782	0.004	-19.399	-53.561	2.10E-03	46.394	-13.612	0.209	10.821
48	-14.740	0.183	-9.378	-55.969	0.002	18.132	-51.409	2.69E-03	59.748	-13.577	0.209	10.943
49	-15.851	0.161	-5.331	-51.386	0.003	-156.870	-52.064	2.49E-03	153.630	-13.195	0.219	8.642
50	-16.936	0.142	6.887	-60.915	0.001	170.810	-57.077	1.40E-03	113.840	-13.880	0.202	8.910

Note:

1. Data obtained from on-wafer measurement.

Application and Usage

Biassing and Operation

The recommended quiescent DC bias condition for optimum efficiency, performance, and reliability is $V_d = 5$ volts with V_g set for $I_d = 650\text{mA}$. The drain bias voltage range is 3 to 5V and must be applied to both sides of the IC. A single DC gate supply connected to V_g , from either side of the IC, will bias all gain stages. Muting can be accomplished by setting V_g to the pinch-off voltage V_p ($\sim -2\text{V}$). **Care must be taken to not exceed the absolute maximum pinch-off voltage as this will cause the ESD protection diodes to turn on thus causing a substantial increase in gate current.**

An optional output power detector network is also provided. The differential voltage between the Det-Ref and Det-Out pads can be correlated with the RF power emerging from the RF output port. The detected voltage is given by :

$$V = (V_{\text{ref}} - V_{\text{det}}) - V_{\text{ofs}}$$

where V_{ref} is the voltage at the DET_R port, V_{det} is a voltage at the DET_O port, and V_{ofs} is the zero-input-power offset voltage. There are three methods to calculate V_{ofs} :

- 1) V_{ofs} can be measured before each detector measurement (by removing or switching off the power source and measuring $V_{\text{ref}} - V_{\text{det}}$). This method gives an error due to temperature drift of less than $0.01\text{dB}/50^\circ\text{C}$.
- 2) V_{ofs} can be measured at a single reference temperature. The drift error will be less than 0.25dB .
- 3) V_{ofs} can either be characterized over temperature and stored in a lookup table, or it can be measured at two temperatures and a linear fit used to calculate V_{ofs} at any temperature. This method gives an error close to method #1.

Figure 11 illustrates the typical performance for detector sensitivity vs. Pin. With $<0\text{dBm}$ RF input, the diode does not turn on; thus, $[\text{Det}_R - \text{Det}_{\text{Out}} = 0]$. As RF power increases the diode turns on harder; thus, $[\text{Det}_R - \text{Det}_{\text{Out}}]$ increases.

The RF ports are AC coupled at the RF input to the first stage and the RF output of the final stage. No ground wires are needed since ground connections are made with plated through-holes to the backside of the device.

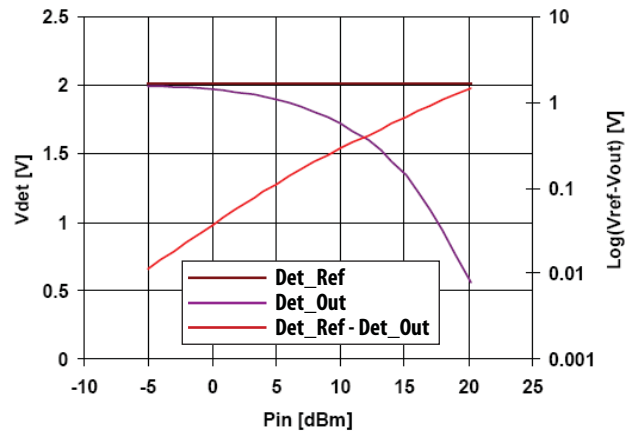

Figure 11. Detector vs. Pin

Assembly Techniques

The chip should be attached directly to the ground plane using electrically conductive epoxy^[1]. For conductive epoxy, the amount should be just enough to provide a thin fillet around the bottom perimeter of the die. The ground plane should be free of any residue that may jeopardize electrical or mechanical attachment. Caution should be taken to not exceed the Absolute Maximum Rating for assembly temperature and time.

Thermo-sonic wedge bonding is the preferred method for wire attachment to the bond pads. The RF connections should be kept as short as possible to minimize inductance. 0.7mil gold wire is recommended. The recommended wire bonding stage temperature is $150 \pm 2^\circ\text{C}$.

The chip is $100\mu\text{m}$ thick and should be handled with care.

This MMIC has exposed air bridges on the top surface. Handle at the edges or with a custom collet (do not pick up die with vacuum on die center).

This MMIC is also static sensitive and ESD handling precautions should be taken.

For more detailed information, see Avago Application Note 54 "GaAs MMIC ESD, Die Attach and Bonding Guide lines."

Notes:

1. Sumitomo 1295SA silver epoxy is recommended.
2. Eutectic attach is not recommended and may jeopardize reliability of the device.

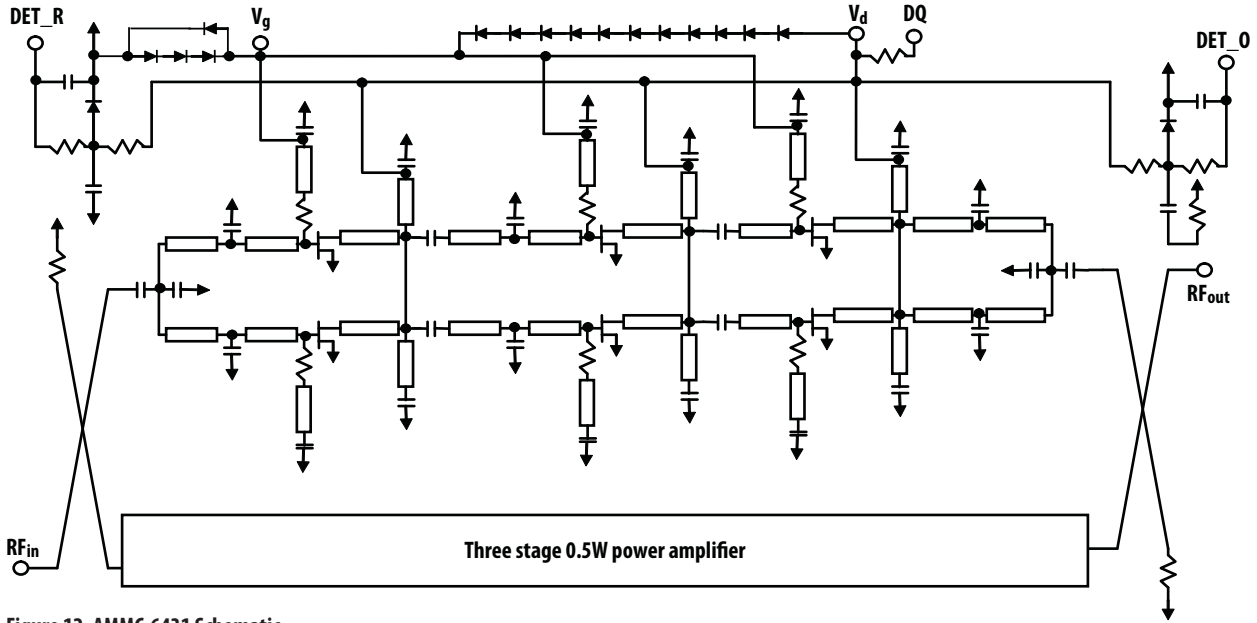

Figure 12. AMMC-6431 Schematic

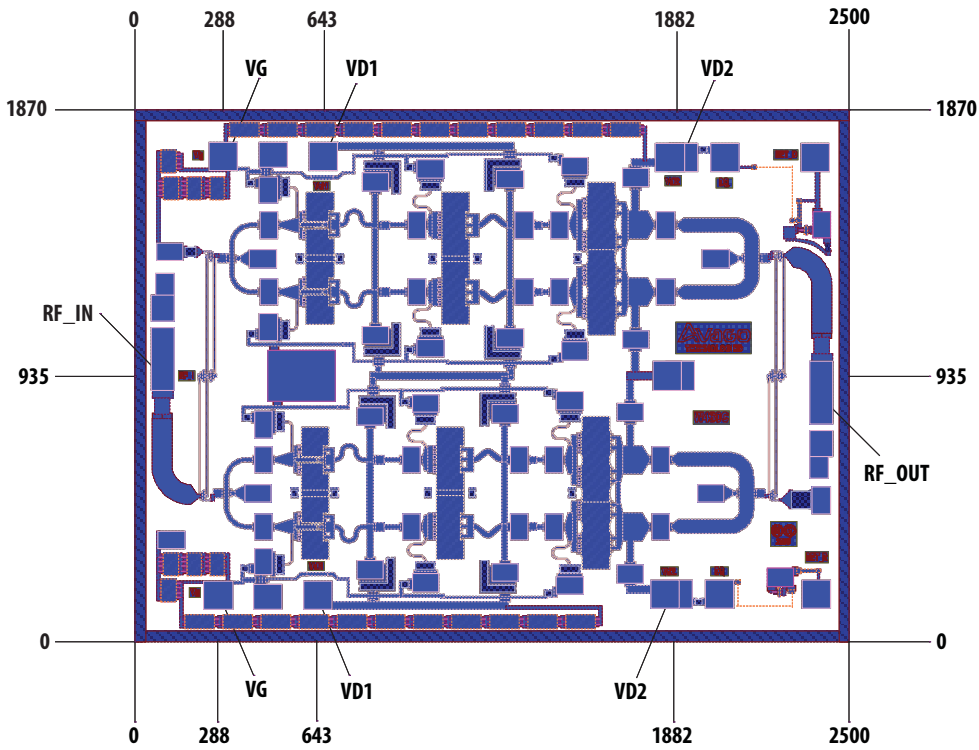

Figure 13. AMMC6431 Die dimension

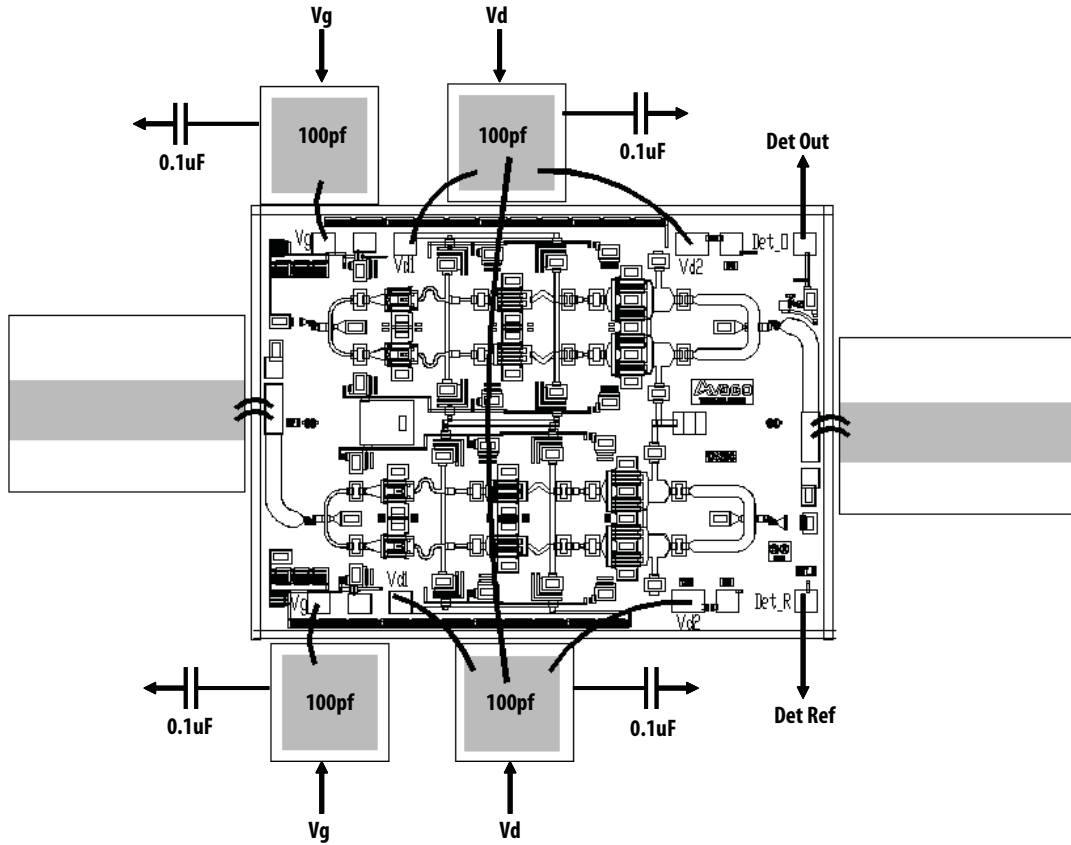

Figure 14. AMMC-6431 assembly example

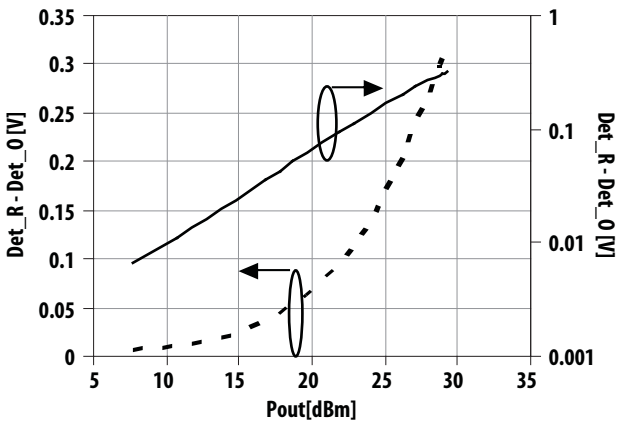

Figure 15. AMMC-6431 typical Detector Voltage and Output Power, Freq=30GHz

Ordering Information:

AMMC-6431-W10 = 10 devices per tray
 AMMC-6431-W50 = 50 devices per tray

For product information and a complete list of distributors, please go to our web site: www.avagotech.com