

AMMP-5618

6–20 GHz General Purpose Amplifier

Data Sheet

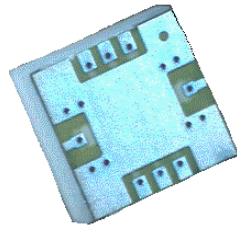

Description

Avago's AMMP-5618 is a high power, medium gain amplifier that operates from 6 GHz to 20 GHz. The amplifier is designed to be an easy-to-use component for any surface mount PCB application. In communication systems, it can be used as a LO buffer, or as a transmit driver amplifier. During typical operation with a single 5V supply, each gain stage is biased for Class-A operation for optimal power output with minimal distortion. The amplifier has integrated 50Ω I/O match, DC blocking, self-bias and choke to eliminate complex tuning and assembly processes typically required by hybrid (discrete-FET) amplifiers. The package is fully SMT compatible with backside grounding and I/O to simplify assembly.

Note: These devices are ESD sensitive. The following precautions are strongly recommended. Ensure that an ESD approved carrier is used when dice are transported from one destination to another. Personal grounding is to be worn at all times when handling these devices.

Features

- 5 x 5 mm surface mount package
- Broad band performance 6–20 GHz
- High +19 dBm output power
- Medium 13 dB typical gain
- 50Ω input and output match
- Single 5V (107 mA) supply bias

Applications

- Microwave radio systems
- Satellite VSAT, DBS up/down link
- LMDS & Pt-Pt mmW long haul
- Broadband wireless access (including 802.16 and 802.20 WiMax)
- WLL and MMDS loops
- Commercial grade military

Absolute Maximum Ratings^[1]

Symbol	Parameters/Conditions	Units	Min.	Max.
V_d	Positive Drain Voltage	V		7
I_d	Drain Current	mA		150
P_{in}	CW Input Power	dBm		20
T_{ch}	Operating Channel Temperature	°C		+150
T_{stg}	Storage Case Temperature	°C	-65	+150
T_{max}	Max. Assembly Temp (60 sec max)	°C		+300

Note:

1. Operation in excess of any one of these conditions may result in permanent damage to this device.

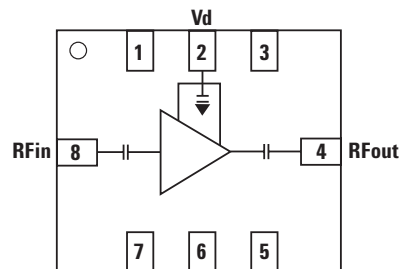

Attention:

Observe precautions for handling electrostatic sensitive devices.

ESD Machine Model (Class A)

ESD Human Body Model (Class 0)

Refer to Avago Application Note A004R: Electrostatic Discharge Damage and Control.

AMMP-5618 DC Specifications/Physical Properties^[1]

Symbol	Parameters and Test Conditions	Units	Min.	Typ.	Max.
I_d	Drain Supply Current (under any RF power drive and temperature) ($V_d=5.0V$)	mA		107	140
θ_{ch-b}	Thermal Resistance ^[2] (Backside temperature, $T_b = 25^\circ C$)	$^\circ C/W$		34	

Notes:

1. Ambient operational temperature $T_A = 25^\circ C$ unless otherwise noted.
2. Channel-to-backside Thermal Resistance ($T_{channel}(T_c) = 34^\circ C$) as measured using infrared microscopy. Thermal Resistance at backside temperature (T_b) = $25^\circ C$ calculated from measured data.

RF Specifications^[3,4,6] ($T_A = 25^\circ C$, $V_d = 5.0V$, $I_{d(Q)} = 107$ mA, $Z_o = 50 \Omega$)

Symbol	Parameters and Test Conditions	Units	Typ.	Sigma
Gain	Small-signal Gain ^[5]	dB	13	0.4
NF	Noise Figure into 50Ω ^[5]	dB	4.4	0.2
P_{-1dB}	Output Power at 1 dB Gain Compression	dBm	+19	0.9
OIP3	Third Order Intercept Point; $\Delta f = 100$ MHz; $P_{in} = -20$ dBm	dBm	+30	1.2
RLin	Input Return Loss	dB	-12	0.7
RLout	Output Return Loss	dB	-12	0.6
Isol	Reverse Isolation	dB	-40	1.2

Notes:

3. Small/Large -signal data measured in a fully de-embedded test fixture form $T_A = 25^\circ C$.
4. Pre-assembly into package performance verified 100% on-wafer per AMMC-5618 published specifications
5. This final package part performance is verified by a functional test correlated to actual performance at one or more frequencies
6. Specifications are derived from measurements in a 50Ω test environment. Aspects of the amplifier performance may be improved over a more narrow bandwidth by application of additional conjugate, linearity, or low noise (Γ_{opt}) matching.

AMMP-5618 Typical Performance ($T_A = 25^\circ\text{C}$, $V_d = 5\text{V}$, $I_d = 107\text{mA}$, $Z_{in} = Z_{out} = 50\Omega$ unless otherwise stated)

Note: These measurements are in 50Ω test environment. Aspects of the amplifier performance may be improved over a narrower bandwidth by application of additional conjugate, linearity or low noise (Γ_{opt}) matching.

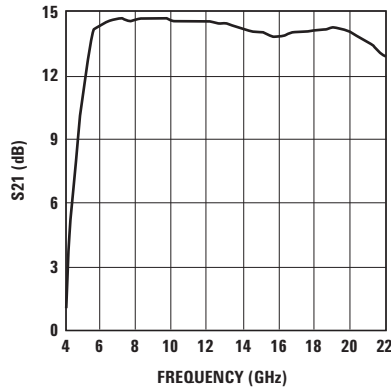

Figure 1. Gain.

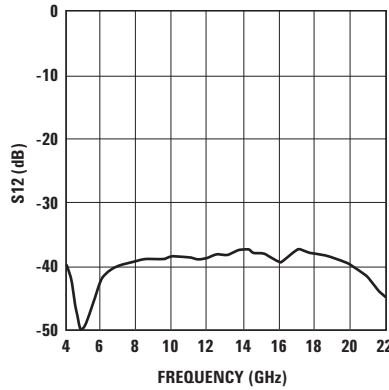

Figure 2. Isolation.

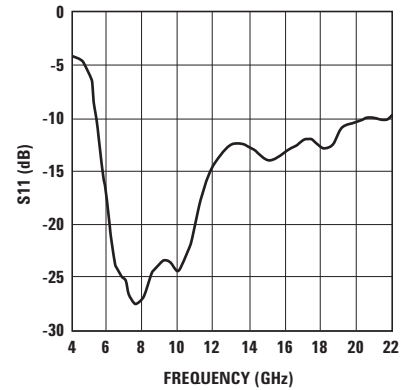

Figure 3. Input Return Loss.

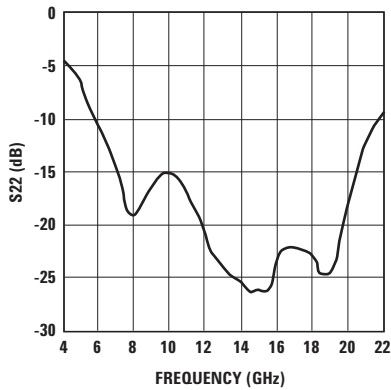

Figure 4. Output Return Loss.

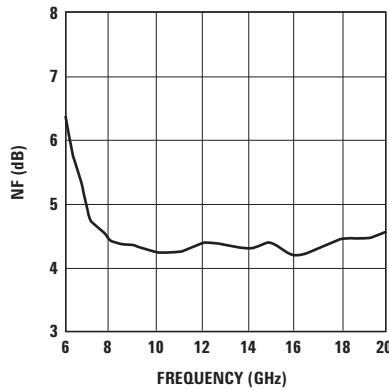

Figure 5. Noise Figure.

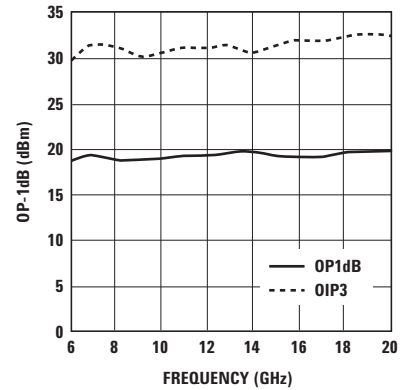

Figure 6. Typical Power, OP-1dB and OIP3.

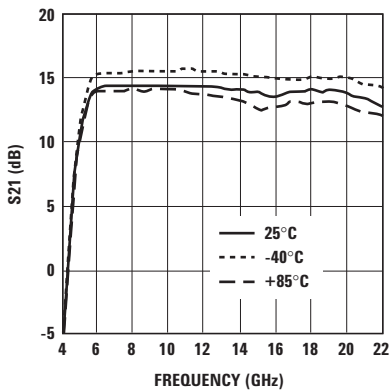

Figure 7. Gain Over Temperature.

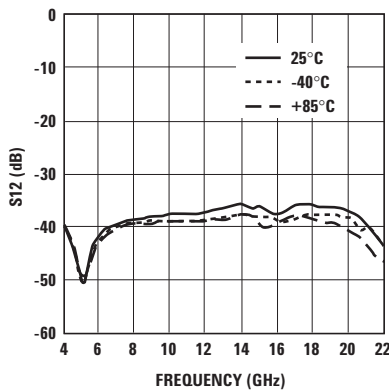

Figure 8. Isolation Over Temperature.

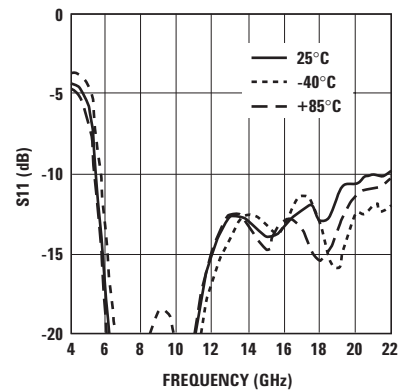

Figure 9. Input RL Over Temperature.

AMMP-5618 Typical Performance ($T_A = 25^\circ\text{C}$, $V_d = 5\text{V}$, $I_d = 107\text{mA}$, $Z_{in} = Z_{out} = 50\Omega$ unless otherwise stated)

Note: These measurements are in 50Ω test environment. Aspects of the amplifier performance may be improved over a narrower bandwidth by application of additional conjugate, linearity or low noise (Γ_{opt}) matching.

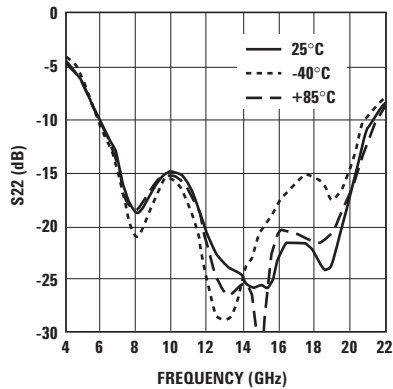

Figure 10. Output Return Loss Over Temperature.

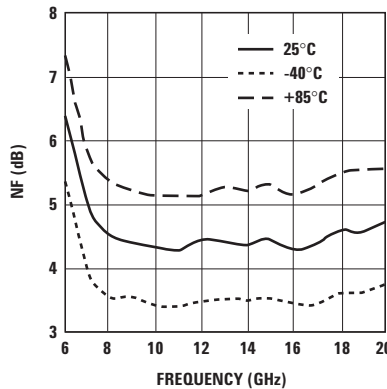

Figure 11. NF Over Temperature.

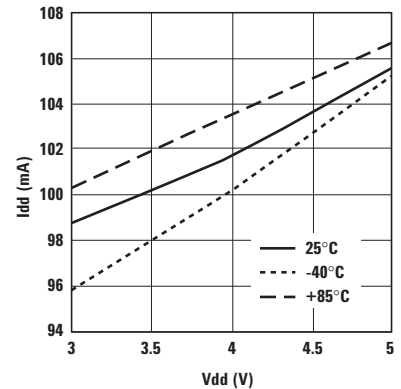

Figure 12. Bias Current Over Temperature.

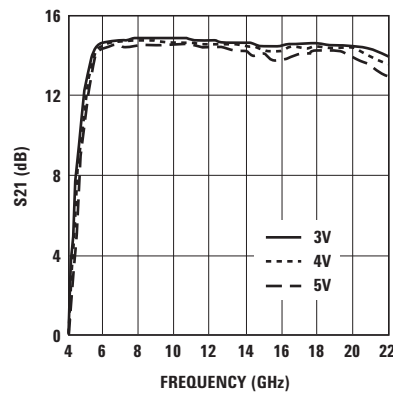

Figure 13. Gain Over Vdd.

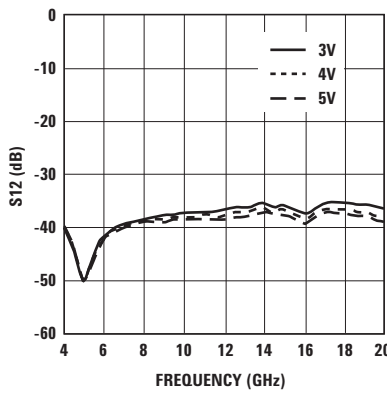

Figure 14. Isolation Over Vdd.

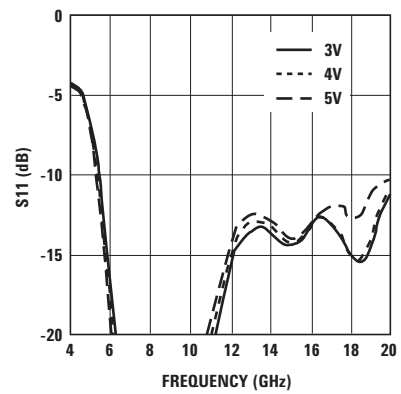

Figure 15. Input RL Over Vdd.

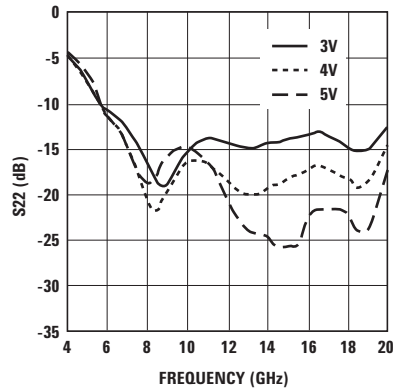

Figure 16. Output Return Loss Over Vdd.

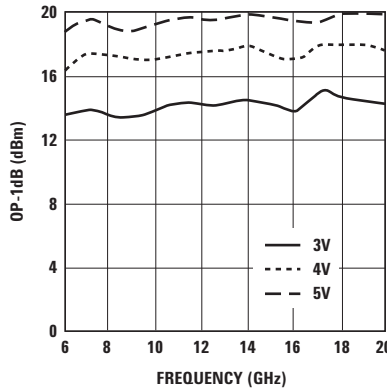

Figure 17. Output Power Over Vdd.

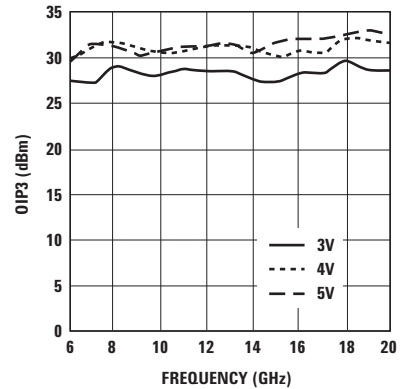

Figure 18. OIP3 Over Vdd.

AMMP-5618 Typical Scattering Parameters^[1] ($T_A = 25^\circ\text{C}$, $V_d = 5\text{V}$, $Z_0 = 50\Omega$)

Freq. GHz	S_{11}			S_{21}			S_{12}			S_{22}		
	dB	Mag	Phase	dB	Mag	Phase	dB	Mag	Phase	dB	Mag	Phase
2.0	-2.995	0.708	70.854	-22.696	0.073	45.614	-58.670	0.001	91.028	-0.537	0.940	118.786
2.5	-3.432	0.674	7.524	-16.093	0.157	62.385	-49.826	0.003	-30.565	-0.694	0.923	56.844
3.0	-4.250	0.613	-59.292	-4.538	0.593	-0.007	-43.091	0.007	172.431	-1.503	0.841	-77.196
3.5	-4.096	0.624	-112.628	-1.726	0.461	-157.105	-36.349	0.015	-48.599	-3.848	0.642	-20.982
4.0	-4.325	0.608	-174.493	0.287	0.394	-52.399	-39.160	0.011	-129.213	-4.217	0.615	-101.456
4.5	-4.797	0.576	121.652	5.870	1.131	-107.307	-42.543	0.007	166.320	-5.052	0.559	-168.104
5.0	-6.417	0.478	52.449	10.805	3.164	-175.227	-50.015	0.003	130.192	-6.475	0.475	130.723
5.5	-11.055	0.280	-16.473	13.764	4.712	108.456	-46.815	0.005	155.918	-8.555	0.373	79.201
6.0	-18.578	0.118	-62.704	14.224	5.385	38.847	-42.183	0.008	114.699	-10.393	0.302	36.021
6.5	-23.802	0.065	-78.360	14.468	5.475	-23.228	-40.719	0.009	69.159	-12.156	0.247	-7.111
7.0	-25.186	0.055	-114.355	14.500	5.495	-75.874	-39.954	0.010	27.235	-14.372	0.191	-54.746
7.5	-27.287	0.043	176.586	14.416	5.506	-127.412	-39.602	0.010	-12.197	-17.196	0.138	-111.340
8.0	-27.021	0.045	89.220	14.509	5.501	-176.352	-39.264	0.011	-50.735	-18.937	0.113	-179.767
8.5	-24.540	0.059	16.508	14.512	5.503	134.523	-39.039	0.011	-88.381	-17.986	0.126	115.789
9.0	-23.582	0.066	-43.865	14.512	5.503	87.924	-38.938	0.011	-124.530	-16.383	0.152	65.272
9.5	-23.477	0.067	-104.344	14.523	5.510	41.684	-38.808	0.011	-160.536	-15.281	0.172	25.081
10.0	-24.304	0.061	-175.038	14.491	5.490	-3.914	-38.711	0.012	163.632	-14.875	0.180	-11.906
10.5	-22.475	0.075	107.849	14.473	5.479	-48.272	-38.711	0.012	128.550	-15.430	0.169	-47.630
11.0	-19.215	0.109	44.619	14.479	5.482	-93.057	-38.700	0.012	92.021	-16.520	0.149	-83.772
11.5	-16.258	0.154	-5.409	14.388	5.425	-137.014	-38.773	0.012	61.222	-18.494	0.119	-122.670
12.0	-14.234	0.194	-51.554	14.419	5.382	179.443	-38.489	0.012	26.022	-20.529	0.094	-163.935
12.5	-13.024	0.223	-95.001	14.367	5.350	136.208	-38.221	0.012	-8.975	-22.659	0.074	150.698
13.0	-12.514	0.237	-138.454	14.328	5.326	92.923	-38.071	0.012	-43.893	-24.039	0.063	107.199
13.5	-12.482	0.238	177.883	14.202	5.249	50.240	-37.739	0.013	-78.798	-24.607	0.059	69.051
14.0	-12.919	0.226	132.024	14.147	5.216	6.926	-37.252	0.014	-114.505	-24.958	0.057	37.568
14.5	-13.636	0.208	87.229	13.972	5.054	-35.308	-37.903	0.013	-153.055	-26.020	0.050	10.165
15.0	-13.993	0.200	38.470	14.029	4.971	-77.276	-37.680	0.013	172.112	-25.949	0.050	-2.864
15.5	-13.835	0.203	-5.903	13.739	4.920	-118.133	-38.692	0.012	133.007	-25.799	0.051	-10.215
16.0	-13.000	0.224	-52.805	13.725	4.969	-158.923	-39.424	0.011	104.224	-23.027	0.071	-27.632
16.5	-12.524	0.236	-103.865	13.966	5.109	158.580	-38.107	0.012	82.267	-21.872	0.081	-63.932
17.0	-12.067	0.222	-152.985	14.024	5.143	115.249	-37.443	0.013	37.833	-21.936	0.080	-90.189
17.5	-11.963	0.200	153.118	14.002	5.130	72.656	-37.604	0.013	0.928	-22.039	0.079	-122.785
18.0	-12.862	0.181	93.198	14.148	5.217	29.105	-37.848	0.013	-35.629	-22.843	0.072	-163.441
18.5	-12.547	0.187	28.065	14.132	5.207	-14.187	-38.170	0.012	-72.292	-24.452	0.060	144.595
19.0	-11.062	0.225	-33.067	14.210	5.254	-58.599	-38.384	0.012	-109.537	-24.014	0.063	83.275
19.5	-10.610	0.272	-88.132	14.091	5.183	-104.365	-39.112	0.011	-147.597	-20.632	0.093	30.364
20.0	-10.469	0.300	-138.271	13.858	5.046	-149.000	-39.698	0.010	176.777	-16.990	0.141	-10.504
20.5	-10.018	0.316	173.388	13.623	4.911	165.396	-40.748	0.009	139.612	-13.793	0.204	-47.217
21.0	-9.997	0.316	122.816	13.398	4.785	122.433	-42.165	0.008	102.558	-11.540	0.265	-83.538
21.5	-10.136	0.311	65.257	13.019	4.797	77.749	-43.928	0.006	74.095	-9.819	0.323	-119.330
22.0	-9.631	0.330	-1.277	12.886	4.724	29.934	-45.145	0.006	49.307	-8.659	0.369	-153.160
22.5	-7.870	0.404	-59.633	12.504	4.219	-13.003	-49.217	0.003	-1.915	-7.188	0.437	166.236
23.0	-5.619	0.524	-127.317	11.738	3.863	-63.650	-47.596	0.004	-40.229	-7.034	0.445	131.591
23.5	-4.449	0.599	171.791	10.831	3.480	-112.183	-53.021	0.002	-136.023	-7.133	0.440	97.415
24.0	-4.155	0.620	119.140	9.293	2.915	-157.885	-51.322	0.003	114.374	-7.517	0.421	61.706
24.5	-4.196	0.617	71.146	8.021	2.518	159.348	-46.344	0.005	21.965	-8.346	0.383	22.766
25.0	-4.530	0.594	23.384	6.897	2.212	116.230	-45.149	0.006	-35.249	-9.765	0.325	-21.448

Note:

1. Data obtained from in fixture de-embedded to package edge.

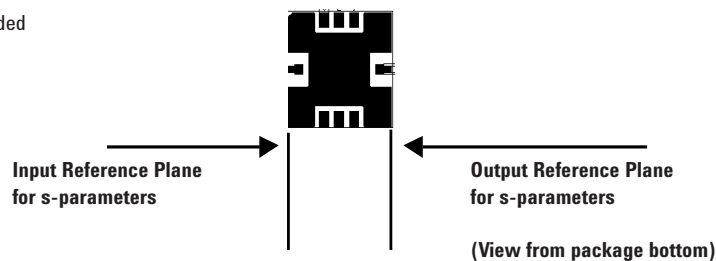

Biasing and Operation

The AMMC-5618 is normally biased with a single positive drain supply connected to both V_D pins through bypass capacitors as shown in Figure 19. The recommended supply voltage is 5V. It is important to have 0.1 μF bypass capacitor, and the capacitor should be placed as close to the component as possible.

The AMMC-5618 does not require a negative gate voltage to bias any of the two stages. No ground wires are needed because all ground connections are made with plated through-holes to the backside of the package.

Refer to the Absolute Maximum Ratings table for allowed DC and thermal conditions.

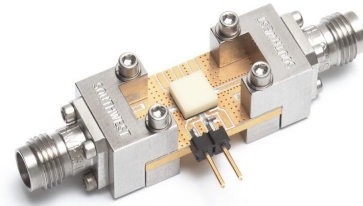

Figure 21. Demonstration Board (available upon request).

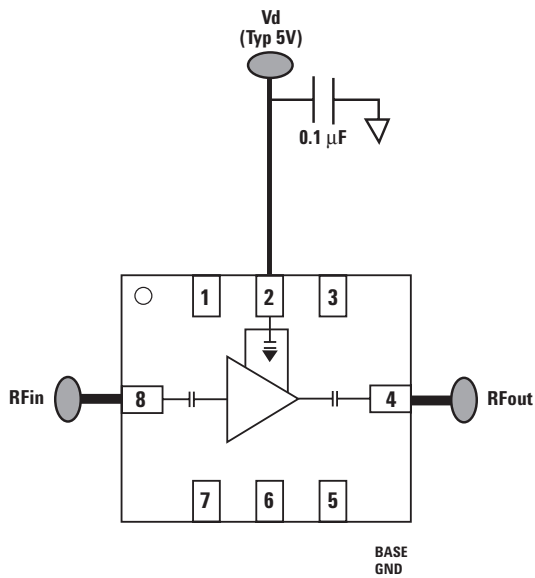

Figure 19. Typical Application.

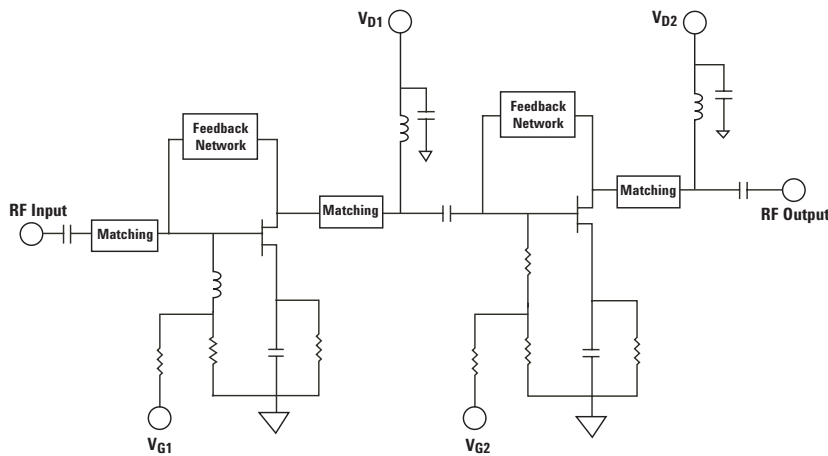
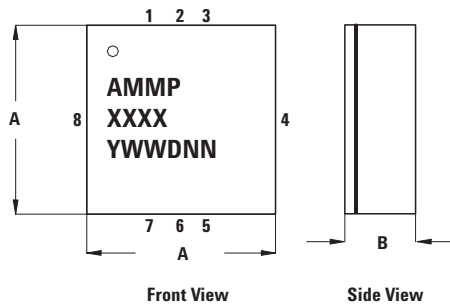
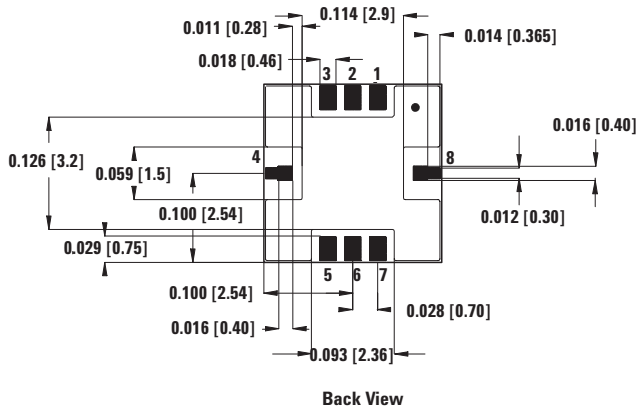

Figure 20. Simplified MMIC Schematic.



Symbol	Min	Max
A	0.198 (5.03)	0.213 (5.4)
B	0.0685 (1.74)	0.088 (2.25)



Notes:

1. * Indicates Pin 1
2. Dimensions are in inches [millimeters]
3. All Grounds must be soldered to PCB RF Ground

Dimensional tolerance for back view: 0.002" [0.05 mm]

Figure 22. Outline Drawing.

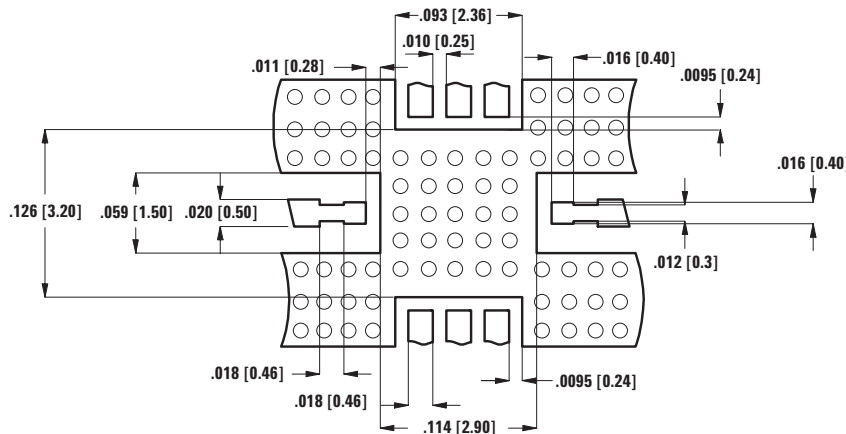

Figure 23. Suggested PCB Material and Land Pattern.

Recommended SMT Attachment

The AMMP Packaged Devices are compatible with high volume surface mount PCB assembly processes.

The PCB material and mounting pattern, as defined in the data sheet, optimizes RF performance and is strongly recommended.

An electronic drawing of the land pattern is available upon request from Avago Sales & Application Engineering.

Manual Assembly

1. Follow ESD precautions while handling packages.
2. Handling should be along the edges with tweezers.
3. Recommended attachment is conductive solder paste. Please see recommended solder reflow profile. Conductive epoxy is **not** recommended. Hand soldering is **not** recommended.
4. Apply solder paste using a stencil printer or dot placement. The volume of solder paste will be dependent on PCB and component layout and should be controlled to ensure consistent mechanical and electrical performance.
5. Follow solder paste and vendor's recommendations when developing a solder reflow profile. A standard profile will have a steady ramp up from room temperature to the pre-heat temperature to avoid damage due to thermal shock.
6. Packages have been qualified to withstand a peak temperature of 260°C for 20 seconds. Verify that the profile will not expose device beyond these limits.

Solder Reflow Profile

The most commonly used solder reflow method is accomplished in a belt furnace using convection heat transfer. The suggested reflow profile for automated reflow processes is shown in Figure 24. This profile is designed to ensure reliable finished joints. However, the profile indicated in Figure 1 will vary among different solder pastes from different manufacturers and is shown here for reference only.

Stencil Design Guidelines

A properly designed solder screen or stencil is required to ensure optimum amount of solder paste is deposited onto the PCB pads. The recommended stencil layout is shown in Figure 25. The stencil has a solder paste deposition opening approximately 70% to 90% of the PCB pad. Reducing stencil opening can potentially generate more voids underneath. On the other hand, stencil openings larger than 100% will

lead to excessive solder paste smear or bridging across the I/O pads. Considering the fact that solder paste thickness will directly affect the quality of the solder joint, a good choice is to use a laser cut stencil composed of 0.127 mm (5 mils) thick stainless steel which is capable of producing the required fine stencil outline.

The combined PCB and stencil layout is shown in Figure 26.

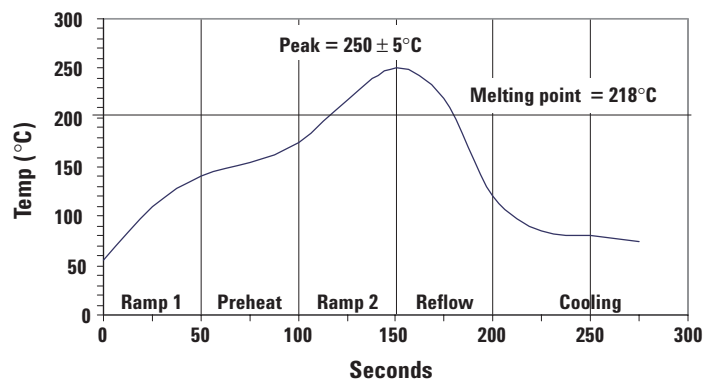

Figure 24. Suggested Lead-Free Reflow Profile for SnAgCu Solder Paste.

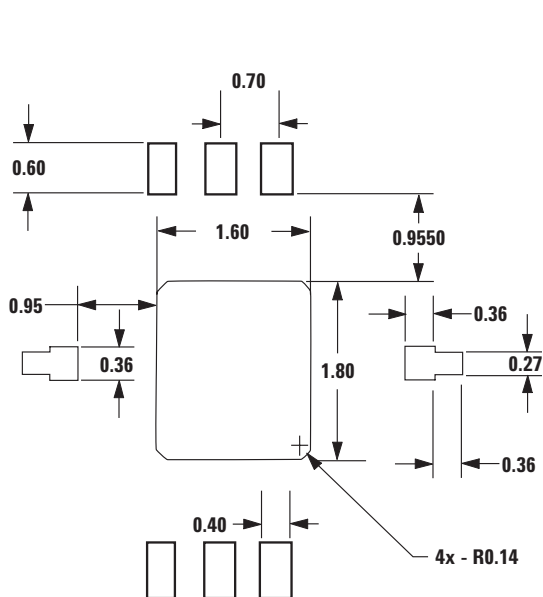

Figure 25. Stencil Outline Drawing (mm).

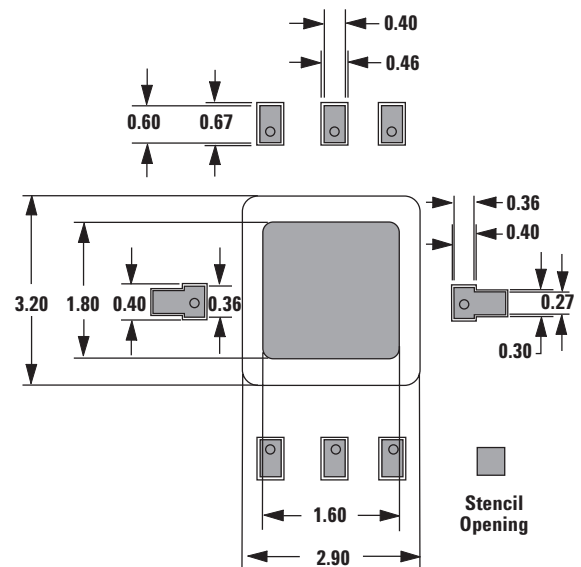
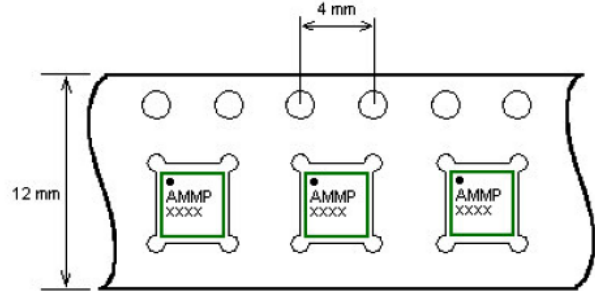

Figure 26. Combined PCB and Stencil Layouts (mm).

Part Number Ordering Information

Part Number	Devices per Container	Container
AMMP-5618-BLK	10	antistatic bag
AMMP-5618-TR1	100	7" Reel
AMMP-5618-TR2	500	7" Reel

Device Orientation (Top View) www.DataSheet4U.com



Carrier Tape and Pocket Dimensions

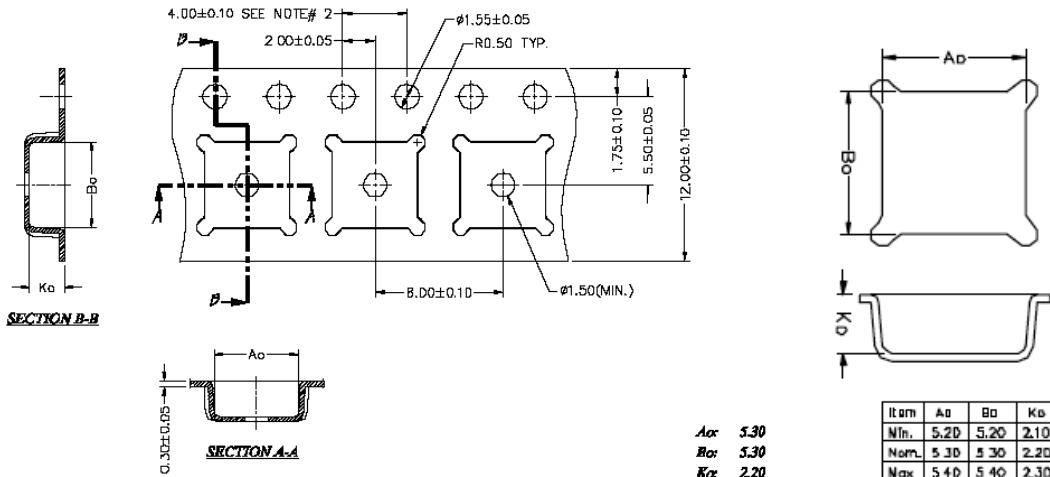

- NOTES:**
1. A_0 & B_0 measured at 0.3mm above base of pocket.
 2. 10 pitches cumulative tol. ± 0.2 mm

A_0 : 5.30
 B_0 : 5.30
 K_0 : 2.20
Pitch: 8.00
Width: 12.00

Item	A_0	B_0	K_0
Min.	5.20	5.20	2.10
Norm.	5.30	5.30	2.20
Max.	5.40	5.40	2.30

For product information and a complete list of distributors, please go to our web site:
www.avagotech.com

Avago, Avago Technologies, and the A logo are trademarks of Avago Technologies, Limited in the United States and other countries.
 Data subject to change. Copyright © 2006 Avago Technologies, Limited. All rights reserved.
 Obsoletes 5989-3210EN
 5989-3545EN April 24, 2006

