

AMR134x

High-Sensitivity Pneumatic Cylinder Switch Sensor

Description

The AMR134x is a digital omnipolar magnetic switch that integrates magnetoresistance and CMOS technology to provide a magnetically triggered digital switch with high sensitivity, high speed, and low power consumption. It is designed for pneumatic cylinder position sensing in industrial applications.

It contains a full-bridge push-pull anisotropic magnetoresistance (AMR) sensor and CMOS signal processing circuitry within the same package, including an on-chip voltage generator and voltage amplifier and comparator for precise magnetic sensing, plus a Schmitt trigger to provide switching hysteresis for noise rejection, and CMOS push-pull output. An internal band gap regulator is used to provide a temperature compensated supply voltage for internal circuits, permitting a wide range of supply voltages.

The AMR134x operates in low voltage and draws only 40 μA resulting in low power operation. It has fast response, accurate switching points, excellent thermal stability, and immunity to stray field interference.

AMR134x is available in two compact DFN3L ($2 \times 2 \times 0.55 \text{ mm}$) and LGA3L ($2 \times 1.5 \times 0.63 \text{ mm}$) packages.

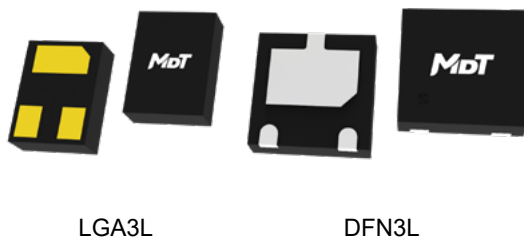

Features and Benefits

- Anisotropic magnetoresistance (AMR) technology
- Low power consumption: 40 μA
- Power cycling latching switch
- Fast switching frequency: typ. 1 kHz
- Omnipolar operation
- High sensitivity
- Wide range of supply voltages
- Excellent temperature stability
- High tolerance to external magnetic field interference
- RoHS & REACH compliant

Applications

- Pneumatic cylinder position switches

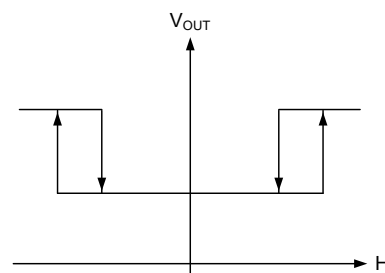
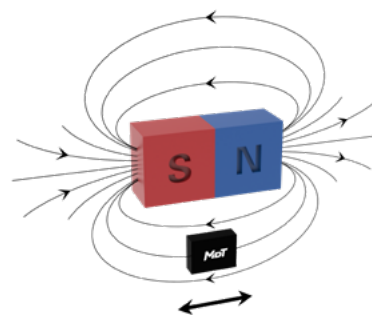

Selection Guide

Part Number	Supply Current	Switching Frequency	Operating Ambient Temperature	Operating Point	Release Point	Package	Packing Form
AMR1341D	40 μ A	1 kHz	-40°C to 125°C	± 15 Gs	± 10 Gs	DFN3L	Tape & Reel
AMR1341G	40 μ A	1 kHz	-40°C to 125°C	± 15 Gs	± 10 Gs	LGA3L	Tape & Reel
AMR1342D	40 μ A	1 kHz	-40°C to 125°C	± 35 Gs	± 27 Gs	DFN3L	Tape & Reel
AMR1342G	40 μ A	1 kHz	-40°C to 125°C	± 35 Gs	± 27 Gs	LGA3L	Tape & Reel

Note: Please contact MultiDimension Technology local sales for customizing operating and release points.

Catalogue

1. Functional Block Diagram.....	03
2. Switching Characteristics	03
3. Pin Configuration	03
4. Absolute Maximum Ratings	04
5. Electrical Specifications.....	04
6. Magnetic Specifications.....	05
7. Typical Supply Voltage Characteristics.....	06
8. Typical Temperature Characteristics	07
9. Application Information	08
10. Dimensions.....	09

1. Functional Block Diagram

AMR134x series switches are composed of AMR sensors and signal processing circuits. The AMR sensor detects external magnetic field, generates an analog voltage signal, and outputs a logical switch level after processing by the circuit as shown in Figure 1.

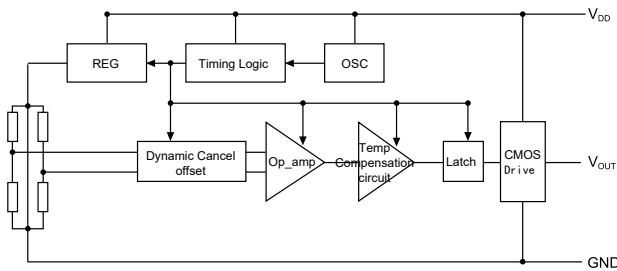

Figure 1. Block diagram

2. Switching Characteristics

The Figure 2 shows the sensing direction is parallel to the silkscreen surface of the package as shown by the arrow.

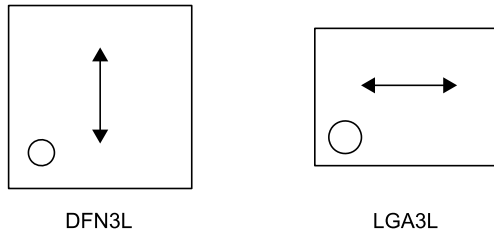

Figure 2. Sensing direction

The output is “High”, when power is on at zero magnetic field. B is the external magnetic field along the sensing direction, B_{OPS} (B_{OPN}) is the operating point, B_{RPS} (B_{RPN}) is the release point, and hysteresis B_H is define as the difference between B_{OPS} and B_{RPS} (B_{OPN} and B_{RPN}).

The sensor outputs a high level, when the magnetic field along the sensing axis exceeds the operate point B_{OPS} (B_{OPN}), and the device outputs a low level, when the magnetic field is reduced below the release point B_{RPS} (B_{RPN}) as shown in Figure 3.

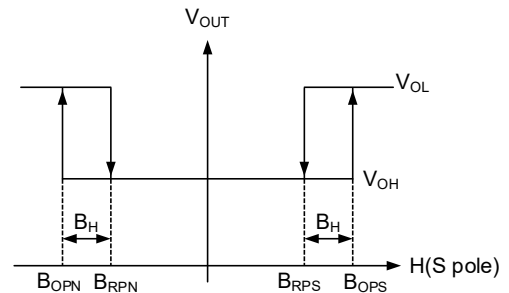

Figure 3. Switching characteristics

3. Pin Configuration

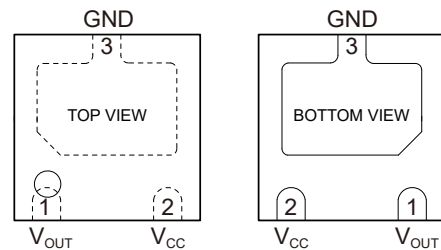

Figure 4-1. Pin configuration (DFN3L)

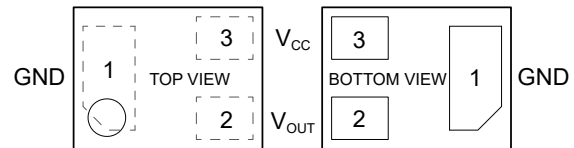

Figure 4-2. Pin configuration (LGA3L)

Pin Number		Name	Function
DFN3L	LGA3L		
1	2	V_{OUT}	Output
2	3	V_{CC}	Power supply
3	1	GND	Ground

4. Absolute Maximum Ratings

Parameters	Symbol	Min.	Max.	Unit
Supply voltage	V_{CC}	-	7	V
Reverse supply current	V_{RCC}	-	0.3	V
Output current	I_{SINK}	-	20	mA
Magnetic flux density	B	-	5000	Gs
ESD performance (HBM)	V_{ESD}	-	2	kV
Operating ambient temperature	T_A	-40	125	°C
Storage ambient temperature	T_{STG}	-50	150	°C

5. Electrical Specifications

$V_{CC} = 1.8\text{ V}$, $T_A = 25\text{ °C}$, a $0.1\text{ }\mu\text{F}$ capacitor is connected between V_{CC} and GND unless specified otherwise

Parameter	Symbol	Condition	Min.	Typ.	Max.	Unit
Supply voltage	V_{CC}	Operating	1.6	1.8	5	V
Output high voltage	V_{OH}	-	$V_{CC} - 0.2$	-	V_{CC}	V
Output low voltage	V_{OL}	OUT = L, $V_{CC} = 3\text{ V}$, $I_{SINK} = 10\text{ mA}$	0	-	0.2	V
Supply current - average	I_{CC}	-	-	40	-	μA
Supply current – sleep	$I_{CC-sleep}$	-	-	30	-	μA
Supply current - awake	$I_{CC-awake}$	-	-	250	-	μA
Switching frequency	F	-	-	1000	-	Hz

6. Magnetic Specifications

$V_{CC} = 1.8\text{ V}$, $T_A = 25\text{ }^\circ\text{C}$, a $0.1\text{ }\mu\text{F}$ capacitor is connected between V_{CC} and GND unless specified otherwise

AMR1341

Parameter	Symbol	Min.	Typ.	Max.	Unit
Operate point	B_{OPS}	10	15	25	Gs
	B_{OPN}	-25	-15	-10	Gs
Release point	B_{RPS}	5	10	20	Gs
	B_{RPN}	-20	-10	-5	Gs
Hysteresis	B_H	2	5	10	Gs

AMR1342

Parameter	Symbol	Min.	Typ.	Max.	Unit
Operate point	B_{OPS}	20	35	55	Gs
	B_{OPN}	-55	-35	-20	Gs
Release point	B_{RPS}	10	27	45	Gs
	B_{RPN}	-45	-27	-10	Gs
Hysteresis	B_H	3	8	18	Gs

7. Typical Supply Voltage Characteristics

AMR134x Supply Voltage Characteristics

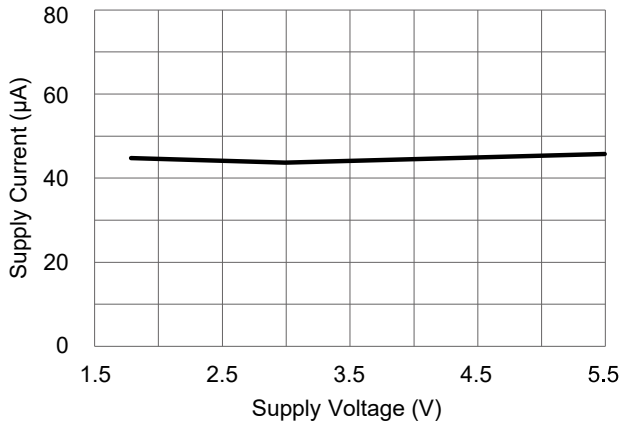

Figure 5. Supply current versus supply voltage ($T_A=25^\circ\text{C}$)

AMR1341D Supply Voltage Characteristics

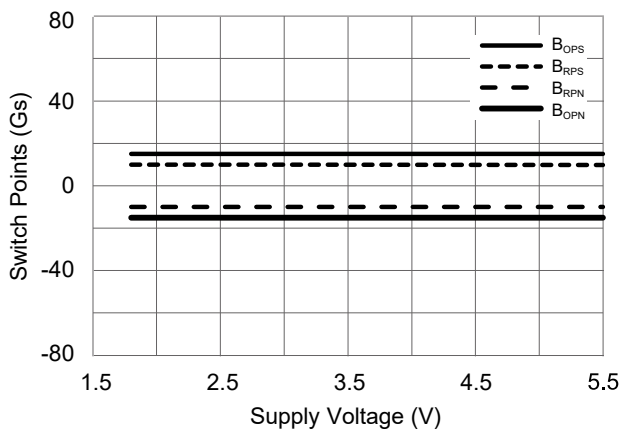

Figure 6. Switch points versus supply voltage ($T_A=25^\circ\text{C}$)

AMR1341G Supply Voltage Characteristics

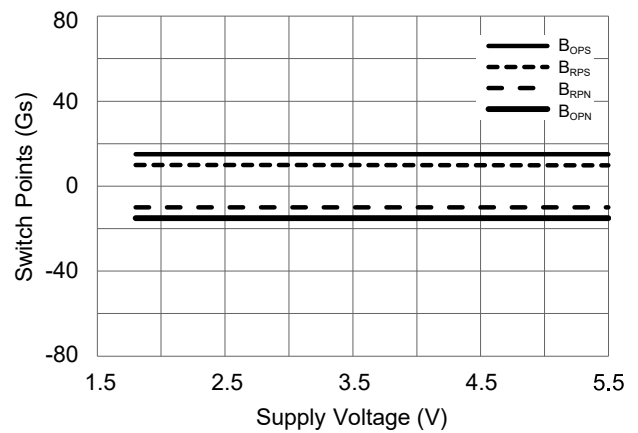

Figure 7. Switch points versus supply voltage ($T_A=25^\circ\text{C}$)

AMR1342D Supply Voltage Characteristics

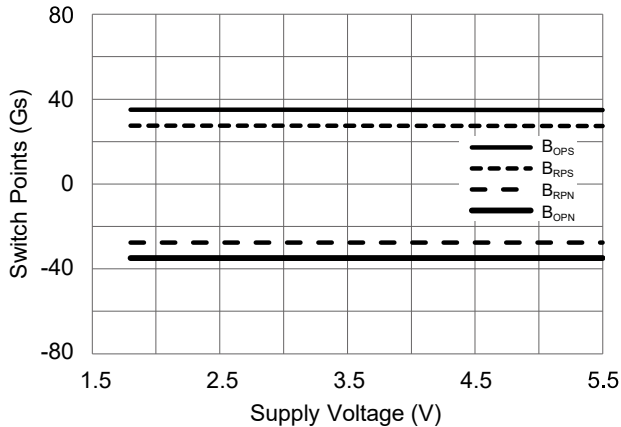

Figure 8. Switch points versus supply voltage ($T_A=25^\circ\text{C}$)

AMR1342G Supply Voltage Characteristics

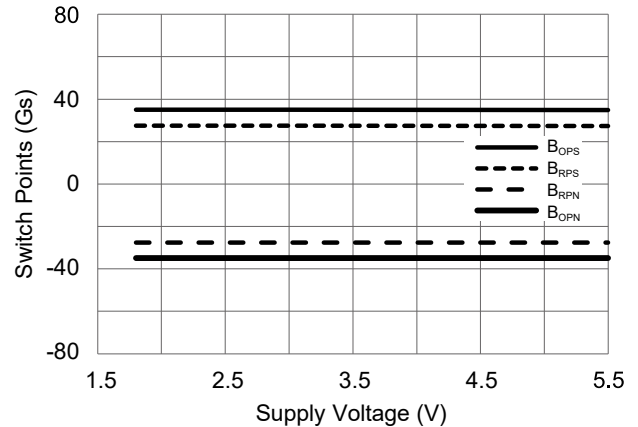

Figure 9. Switch points versus supply voltage ($T_A=25^\circ\text{C}$)

8. Typical Temperature Characteristics

AMR134x Temperature Characteristics

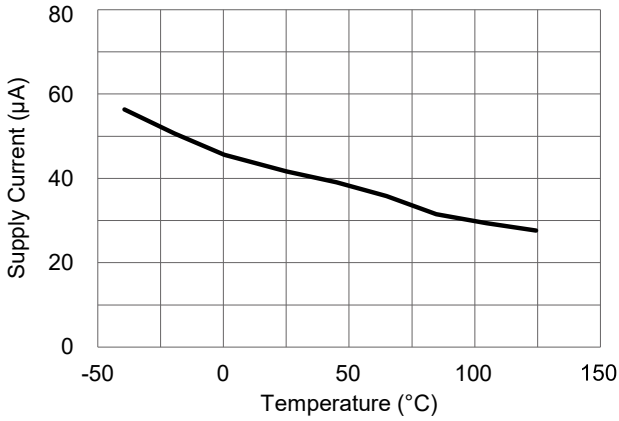

Figure 10. Supply current versus temperature ($V_{CC}=1.8V$)

AMR1341D Temperature Characteristics

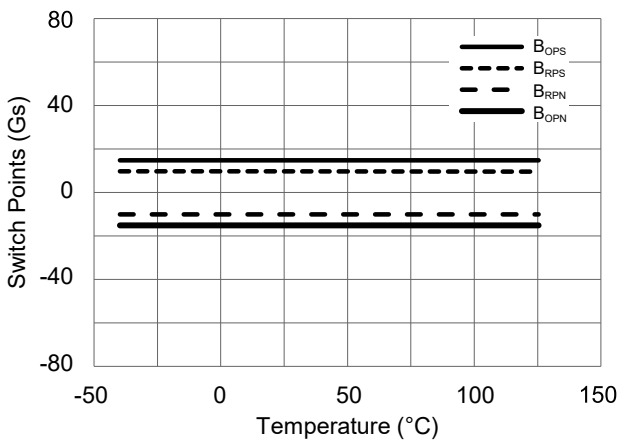

Figure 11. Switch points versus temperature ($V_{CC}=1.8V$)

AMR1341G Temperature Characteristics

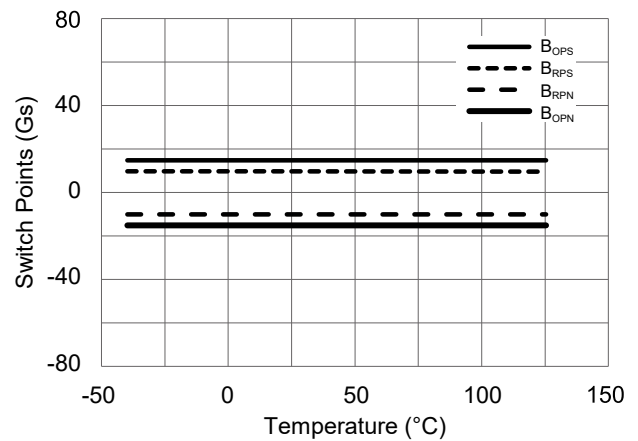

Figure 12. Switch points versus temperature ($V_{CC}=1.8V$)

AMR1342D Temperature Characteristics

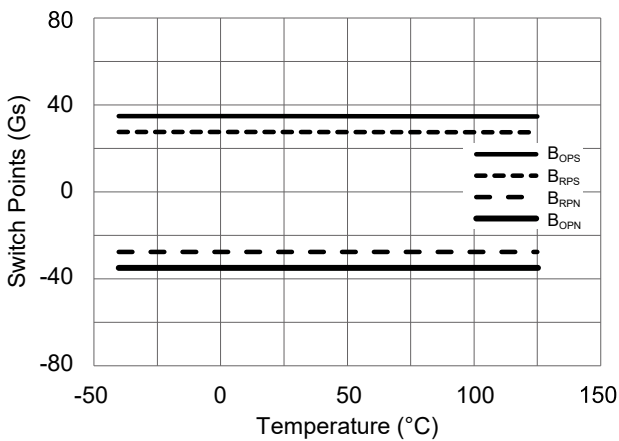

Figure 13. Switch points versus temperature ($V_{CC}=1.8V$)

AMR1342G Temperature Characteristics

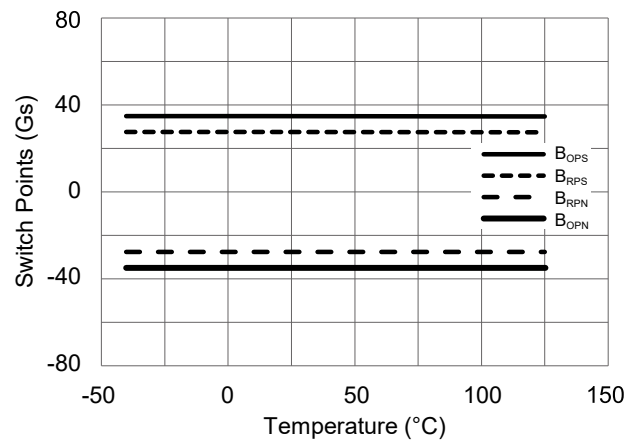

Figure 14. Switch points versus temperature ($V_{CC}=1.8V$)

9. Application Information

It is recommended to add a filter capacitor with the typical value of $0.1 \mu\text{F}$ between the switch power supply and ground (close to the sensor) to reduce external noise as shown in Figure 15.

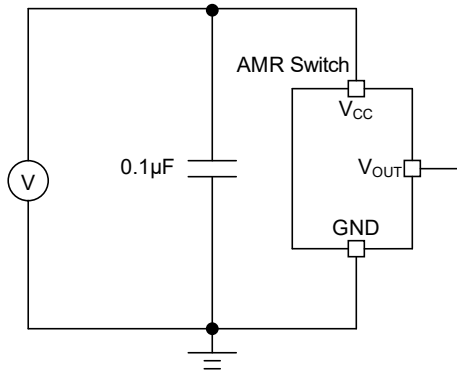

Figure 15. Application circuit diagram

The AMR134x is not suitable for driving power loads. Figure 16 illustrates the general method of improving the drive capability is utilizing the output voltage of V_{OUT} pin as a signal to input the MCU or drive a triode or MOS.

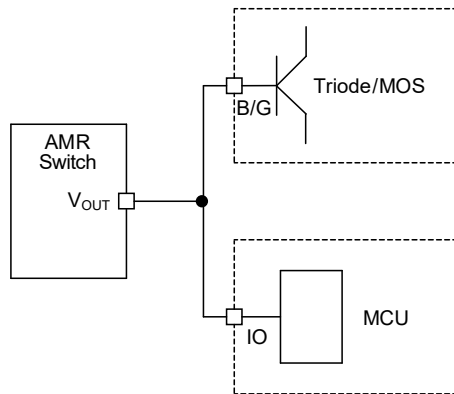

Figure 16. Application diagram for driving power load

Common failure conditions:

- The supply voltage exceeds the limit of absolute maximum ratings
- Absence of matching filter capacitor to power supply when the power supply is unstable, which can cause the product to restart repeatedly
- Using switch output V_{OUT} to control high-power relays, etc., and cause I_{SINK} exceeding the limit of absolute maximum ratings
- The external magnetic field exceeds the limit of absolute maximum ratings
- Operating in a humid environment for a long time, causing vapor penetration and increased power consumption
- Overheating when soldering
- Over bending of pins

10. Dimensions

DFN3L Package

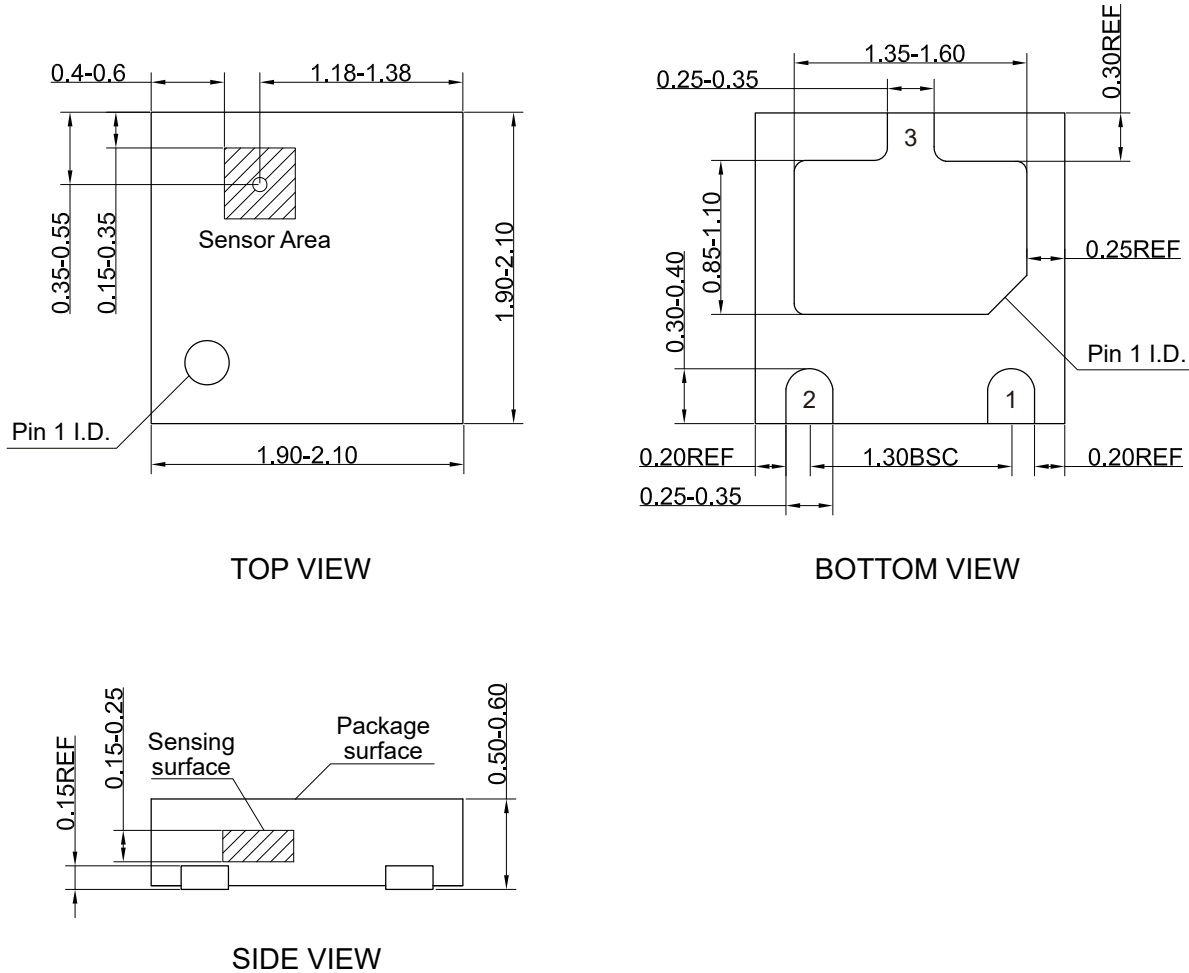

Figure 17. Package outline of DFN3L (unit: mm)

LGA3L Package

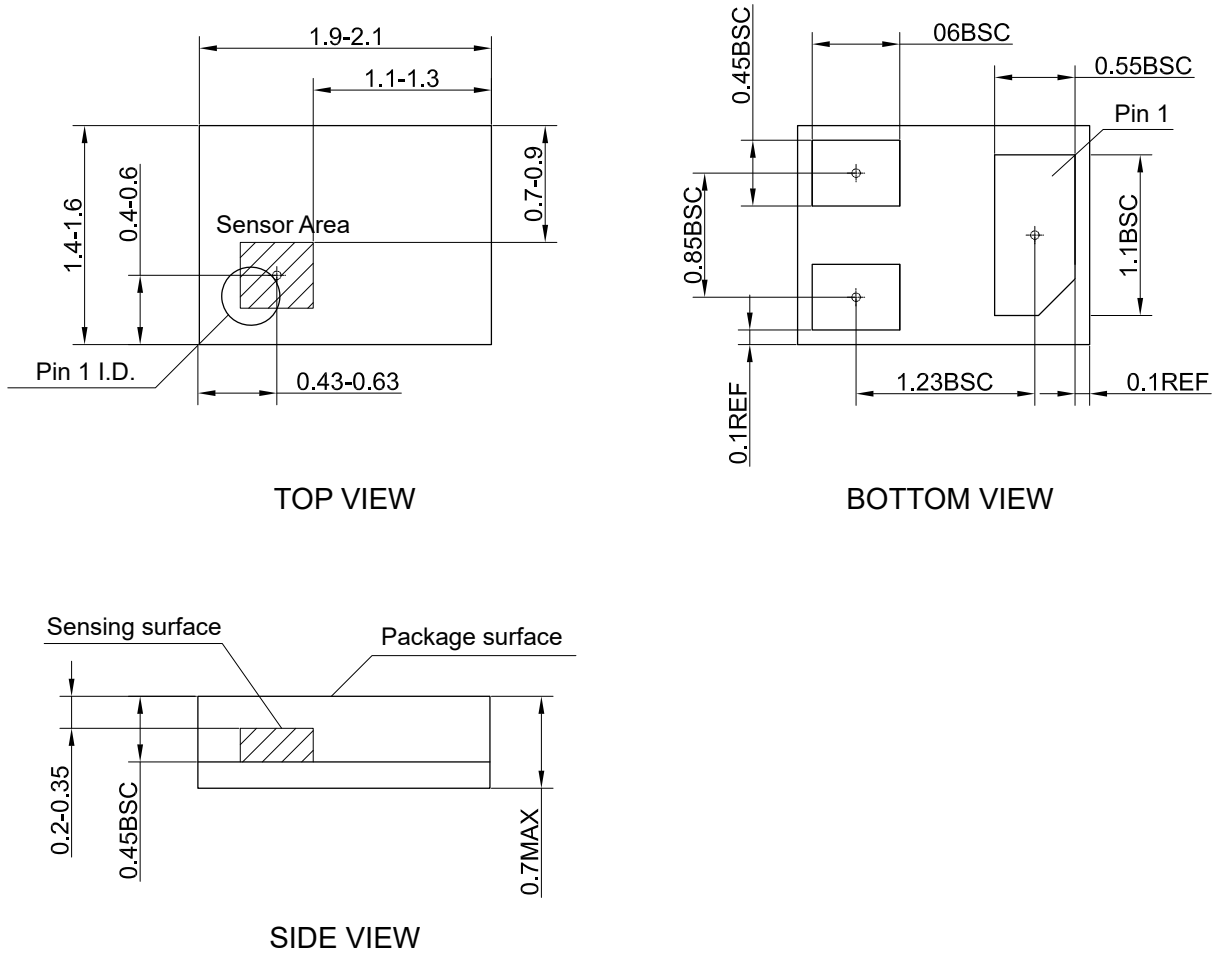

Figure 18. Package outline of LGA3L (unit: mm)

Copyright © 2023 by MultiDimension Technology Co., Ltd.

Information furnished herein by MultiDimension Technology Co., Ltd. (hereinafter MDT) is believed to be accurate and reliable. However, MDT disclaims any and all warranties and liabilities of any kind, with respect to any examples, hints or any performance or use of technical data as described herein and/or any information regarding the application of the product, including without limitation warranties of non-infringement of intellectual property rights of any third party. This document neither conveys nor implies any license under patent or other industrial or intellectual property rights. Customer or any third-party must further determine the suitability of the MDT products for its applications to avoid the applications default of customer or third-party. MDT accept no liability in this respect.

MDT does not assume any liabilities of any indirect, incidental, punitive, special or consequential damages (including without limitation of lost profits, lost savings, business interruption, costs related to the removal or replacement of any products or rework charges) whether or not such damages are based on tort (including negligence), warranty, breach of contract or any other legal theory. Notwithstanding any damages that customer might incur for any reason whatsoever, MDT's aggregate and cumulative liability towards customer for the products described herein shall be limited in accordance with the terms and conditions of commercial sale of MDT.

Absolute maximum ratings are the extreme limits the device will withstand without damage to the MDT product. However, the electrical and mechanical characteristics are not guaranteed as the maximum limits (above recommended operating conditions) are approached. MDT disclaims any and all warranties and liabilities of the MDT product will operate at absolute maximum ratings.

Specifications may change without notice.

Please download latest document from our official website www.dowaytech.com/en.

Recycling

The product(s) in this document need to be handed over to a qualified solid waste management services company for recycling in accordance with relevant regulations on waste classification after the end of the product(s) life.



No.2 Guangdong Road, Zhangjiagang Free Trade Zone, Jiangsu, China

Web: www.dowaytech.com/en E-mail: info@dowaytech.com

