

# AMR3108A

## AMR 180°/360° Magnetic Rotary Encoder Sensor

### Description

The AMR3108A is a contactless, high-precision, and high-speed magnetic rotary encoder sensor, which integrated with anisotropic magnetoresistance (AMR) sensors and CMOS digital signal processing circuitry.

The AMR3108A senses the single pole-pair magnet rotation above the chip by AMR sensors, collects the rotating magnetic field signal, transmits it to the digital processing unit, calculates the rotation angle and outputs 12-bit absolute position signals.

The signal period of AMR3108A is 180° rotation angle. Using the reserved inverted switch interface, it can be extended to the detection of 360° rotation angle.

AMR3108A outputs 12-bit absolute position signal through SPI communication protocol in a 180° rotation period. At the same time, it is able to output A/B phase programmable incremental position signal with 1 to 1024 pulse and programmable zero-point (Z phase) signal. AMR3108A also provides inverted UVW output, analog and PWM signals, with rotational speed up to 20,000 RPM.

### Features and Benefits

- Anisotropic magnetoresistance (AMR) technology
- Contactless measurement
- Available in SPI, ABZ differential, UVW, Analog and PWM interfaces
- 12-bit absolute position output in SPI mode
- Programmable A/B interpolation factors: ×1 to ×1024
- Programmable Z pulse width in 1LSB/2LSB/4LSB/90°
- Programmable inverted UVW output resolution in 1 to 16 pole-pair
- Programmable analog clamping voltage and PWM frequency
- Programmable zero position
- Angular repeatability < ±0.1°
- Speeds up to 20,000 RPM
- Adaptive supply voltage: 3.3 V to 5 V
- RoHS & REACH compliant

### Applications

- Contactless angular position measurement
- Brushless motor position sensing
- Rotary speed sensing
- Stepper motor



TSSOP16



**Selection Guide**

Part Number(*)	Angle Range	Output Interface	SPI Interface Voltage	Operating Temperature	Package	Packing Form
AMR3108AP-2-0-1024	0° to 180°	SPI / ABZ differential	3.3 V to 5.0 V	-40 °C to 125 °C	TSSOP16	Tape & Reel

Note: \*Please contact MDT local sales representative for more model's information.

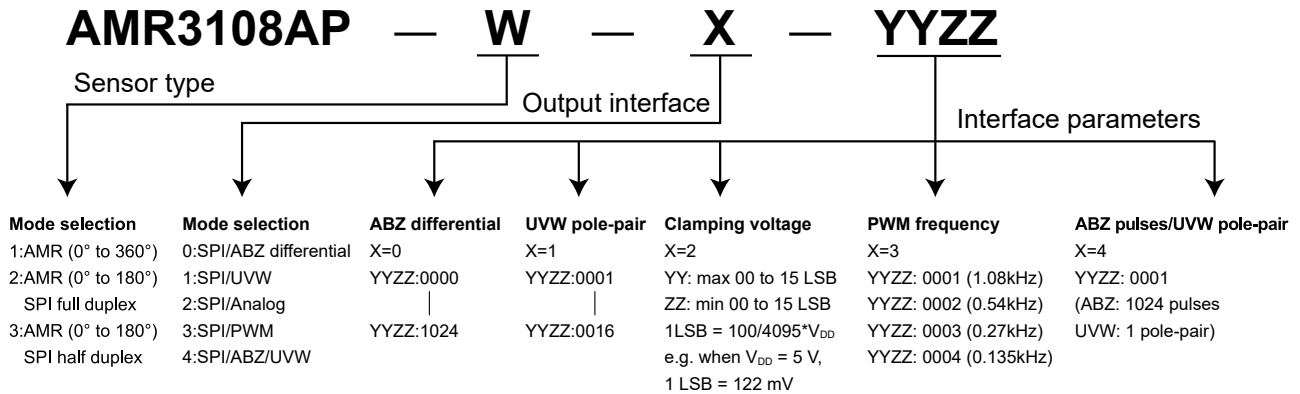

**Catalogue**

1. Pin Configuration .....	03
2. Absolute Maximum Ratings .....	05
3. Electrical Specifications .....	05
4. Signal Conversion Specifications .....	05
5. Digital Interface Signals .....	06
6. Digital Output Signals .....	06
7. Analog Output Characteristics .....	06
8. PWM Characteristics .....	06
9. Magnetic Field Specification .....	07
10. Output mode .....	08
10.1 SPI output .....	08
10.2 ABZ output .....	10
10.3 UVW output .....	11
10.4 Analog output .....	12
10.5 PWM output .....	13
11. Mechanical Angle Orientation .....	14
12. Dimensions .....	15

## 1. Pin Configuration

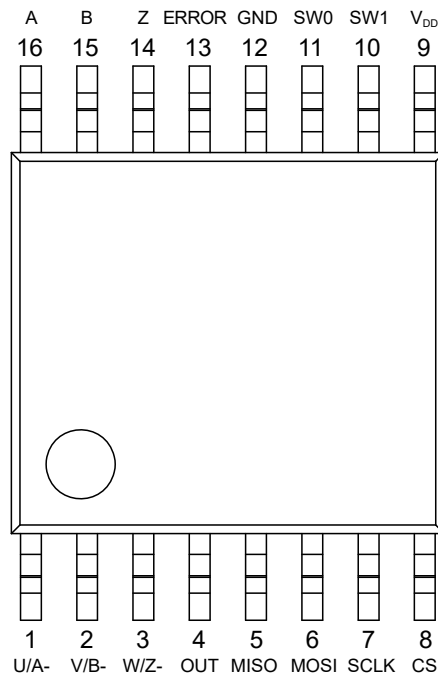

Figure 1. Pin configuration (TSSOP16)

Pin Number	Name	Input/Output	Signal type	Function
1	U/A-	Output	Digital	U phase invert signal or A phase negative pulse signal
2	V/B-	Output	Digital	V phase invert signal or B phase negative pulse signal
3	W/Z-	Output	Digital	W phase invert signal or Z phase negative pulse signal
4	OUT	Output	Analog or digital	Analog linear output or PWM output
5	MISO	Output	Digital	SPI data out
6	MOSI	Input	Digital	SPI data in
7	SCLK	Input	Digital	SPI clock
8	CS	Input	Digital	SPI chip select
9	V <sub>DD</sub>	Input	Power supply	Power supply
10	SW1	Input	Digital	AMR phase signal 1
11	SW0	Input	Digital	AMR phase signal 0
12	GND	Input	GND	Ground
13	ERROR	Output	Digital	Error signal
14	Z	Output	Digital	Phase Z pulse signal
15	B	Output	Digital	Phase B pulse signal
16	A	Output	Digital	Phase A pulse signal

Note:

(1) AMR3108AP can be set to SPI output full duplex while the angle measurement range is 0° to 180° (duplex change from 0 to 4095 LSB in the measurement range). For example: factory default model AMR3108AP-2-0-1024.

(2) AMR3108AP can be set to SPI output half duplex while the angle measurement range is 0° to 180° (duplex change from 0 to 2047 LSB in the measurement range). For example: it is able to set to AMR3108AP-3-0-1024.

(3) AMR3108AP can be set to the angle measurement range is 0° to 360°. For example: it can set to AMR3108AP-1-0-1024. In this mode, two switch sensors (e.g. TMR1202S) should connect to pin SW0 and SW1 of AMR3108AP to determine the phase of signals, and their relative position is shown in Figure 2. AMR3108AP works in saturation status, and therefore, it can provide better accuracy and repeatability than TMR and Hall rotation sensors.

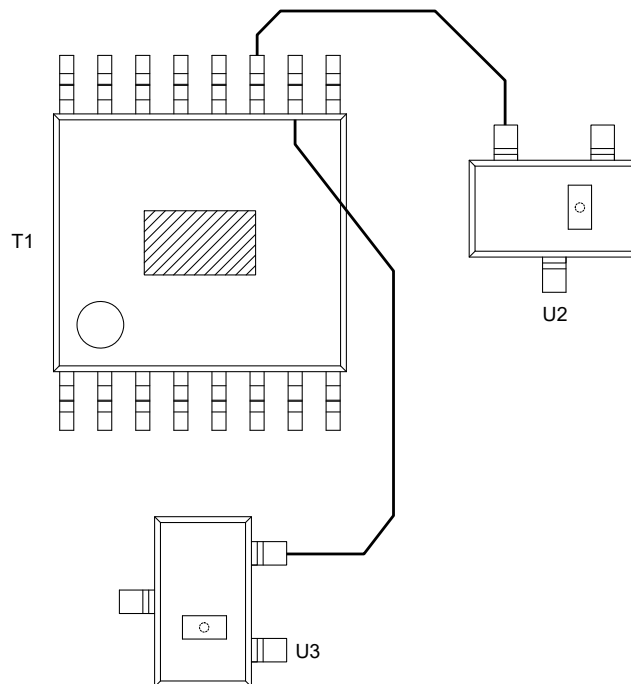

Figure 2. Schematic connection diagram of AMR3108AP and switches (Top view)

(4) The schematic diagram of the output mode below is represented in the following format unless specified otherwise: AMR3108AP-2-X-YYZZ. For example: factory default model is AMR3108AP-2-0-1024.

## 2. Absolute Maximum Ratings

Parameter	Symbol	Min.	Max.	Unit
Supply voltage	$V_{DD}$	-	6	V
Magnetic flux density	B	-	4000	Gs
Operating ambient temperature	$T_A$	-40	125	°C
Storage ambient temperature	$T_{STG}$	-40	150	°C
Ambient humidity (no dew)	HMD	10	90	%RH
ESD performance (HBM)	$V_{ESD}$	-	2	kV

The Absolute Maximum Rating parameters is only a condition to ensure that the chip is not permanently damaged. For normal operating conditions, please refer to Electrical and Magnetic Field Specifications.

## 3. Electrical Specifications

$V_{DD} = 3.3\text{ V to }5\text{ V}$ ,  $T_A = 25\text{ °C}$

Parameter	Symbol	Condition	Min.	Typ.	Max.	Unit
Supply voltage	$V_{DD}$	-	3.3	-	5	V
Supply current	$I_{DD}$	No output load	-	8	10	mA
Output voltage	$V_{OUT}$	MISO, A, B, Z, U, V, W, ERROR	-0.3	-	$V_{DD}$	V
MISO output current	$I_{OUT1}$	-	-1.25	-	1.25	mA
Input voltage	$V_{IN1}$	MOSI, CS, SCLK	-0.3	-	$V_{DD}$	V

## 4. Signal Conversion Specifications

Parameter	Symbol	Condition	Min.	Typ.	Max.	Unit
Measurement range	$A_{range}$	-	0	-	180/360	Deg
Absolute resolution	$RES_{SDC}$	-	-	12	-	bit
Nonlinearity error	$INL_{OPT}$	-	-	-	±0.5	Deg
Nonlinearity error in full temperature range	$INL_{drift}$	-40 °C to 125 °C	-	-	±1.2	Deg
Differential nonlinearity	DNL	-	-	-	±0.044	Deg
Hysteresis	HYS	-	-	-	±0.22	Deg
Repeatability	$A_{repeat}$	-	-	-	±0.088	Deg
Output delay	$T_D$	-	-	5	10	µs
Rotation speed	$R_{speed}$	-	-	-	20000	RPM

## 5. Digital Interface Signals

CS, SCLK, MOSI, MISO

Parameter	Symbol	Condition	Min.	Typ.	Max.	Unit
Input threshold high	$V_{I(HI)}$	-	3.3	-	-	V
Input threshold low	$V_{I(LO)}$	-	-	-	1	V
Output threshold high	$V_{O(HI)}$	I = 1 mA	4.5	-	-	V
Output threshold low	$V_{O(LO)}$	I = 1 mA	-	-	0.5	V
Output load capacitance	$C_L$	-	-	-	100	pF

## 6. Digital Output Signals

A, B, Z, U, V, W

Parameter	Symbol	Condition	Min.	Typ.	Max.	Unit
Saturation voltage high	$V_{S(HI)}$	I = 1 mA	4.5	-	-	V
Saturation voltage low	$V_{S(LO)}$	I = 1 mA	-	-	0.5	V
Rise time	$t_{rise}$	$C_L = 100$ pF	-	-	150	ns
Fall time	$t_{fall}$	$C_L = 100$ pF	-	-	150	ns

## 7. Analog Output Characteristics

Parameter	Symbol	Condition	Min.	Typ.	Max.	Unit
Output load resistance	$R_L$	-	-	10	-	k $\Omega$
Output load capacitance	$C_L$	-	-	10	-	nF
Minimum resolution of digital-to-analog conversion	$DAC_{LSB}$	12 bit	-	0.024	-	% $V_{DD}$
Integral nonlinearity of digital-to-analog conversion	$DAC_{INL}$	-	-	-	$\pm 1$	Deg
Differential nonlinearity of digital-to-analog conversion	$DAC_{DNL}$	-	-	-	$\pm 0.2$	Deg
Analog output noise	$DAC_{noise}$	-	-	-	$\pm 2$	LSB
Proportional error	$E_{rm}$	-	-0.3	-	0.3	%

## 8. PWM Characteristics

Parameter	Symbol	Condition	Min.	Typ.	Max.	Unit
PWM frequency	$F_{PWM}$	Programmable	-10 %	1.08 0.54 0.27 0.135	+10 %	kHz
Rise time	$t_{rise}$	10 nF load	-	-	1	$\mu$ s
Fall time	$t_{fall}$	10 nF load	-	-	1	$\mu$ s

## 9. Magnetic Field Specification

Recommended magnet: cylindrical NdFeB magnet,  $\phi 6$  mm  $\times$  2.5 mm, radial magnetization

Parameter	Symbol	Condition	Min.	Typ.	Max.	Unit
Diameter of magnet	$d_{\text{mag}}$	-	3.0	6.0	20	mm
Thickness of magnet	$t_{\text{mag}}$	-	-	2.5	-	mm
Mounting distance	$D_{\text{in}}$	Recommend magnet	0.5	1	2	mm
Magnetic field	$B_{\text{ext}}$	Sensor surface	300	-	-	Gs
Center deviation between magnet and sensor	$x_{\text{dis}}$	-	-	-	0.25	mm
Center deviation between sensor and package	$x_{\text{pac}}$	-	-0.15	-	0.15	mm
Angle deviation of the sensor within package	$\phi_{\text{pac}}$	-	-3	-	3	Deg
Sensor to package clearance	$h_{\text{pac}}$	-	-	0.4	-	mm

## 10. Output mode

### 10.1 SPI output

AMR3108AP provides the 4-wire SPI interface for user programming in common mode 1 (CPOL = 0, CPHA = 1). Data communication is only enabled when the CS pin is set to LOW. The MOSI pin carries the serial input data that will be written to the IC upon the falling edge of the SCLK signal. The serial output data is available to read at the MISO pin upon the rising edge of the SCLK signal.

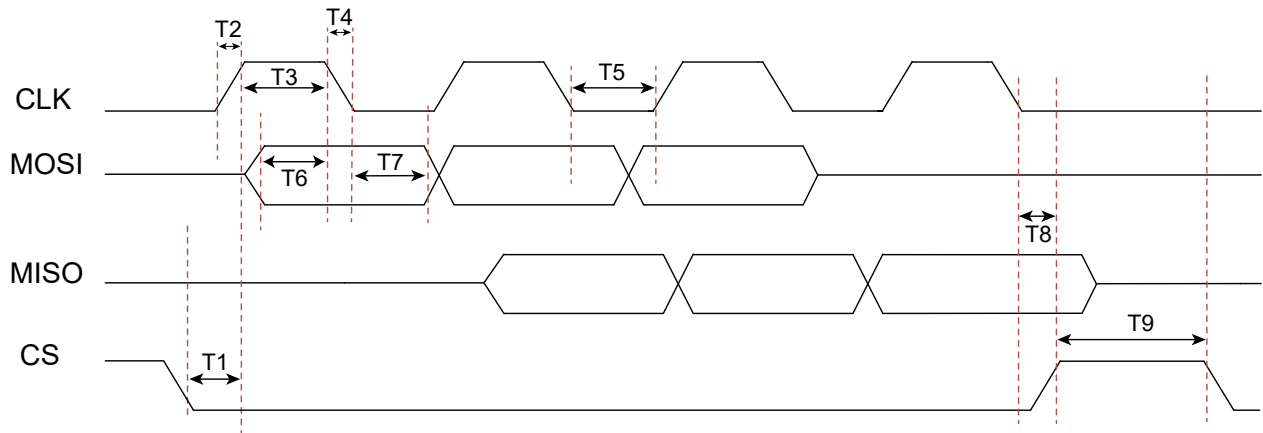

Figure 3. SPI timing diagram

Signal	Definition	Min.	Typ.	Max.	Unit
T1	SPI start-up time	-	150	-	ns
T2/T4	Clock signal rising/falling time	-	-	25	ns
T3	Clock signal HIGH period	150	-	-	ns
T5	Clock signal LOW period	150	-	-	ns
T6	Input signal setup time	100	-	-	ns
T7	Input signal sampling hold time	100	-	-	ns
T8	SPI closing time	-	150	-	ns
T9	SPI reading interval	4	-	-	μs



Reading angular values

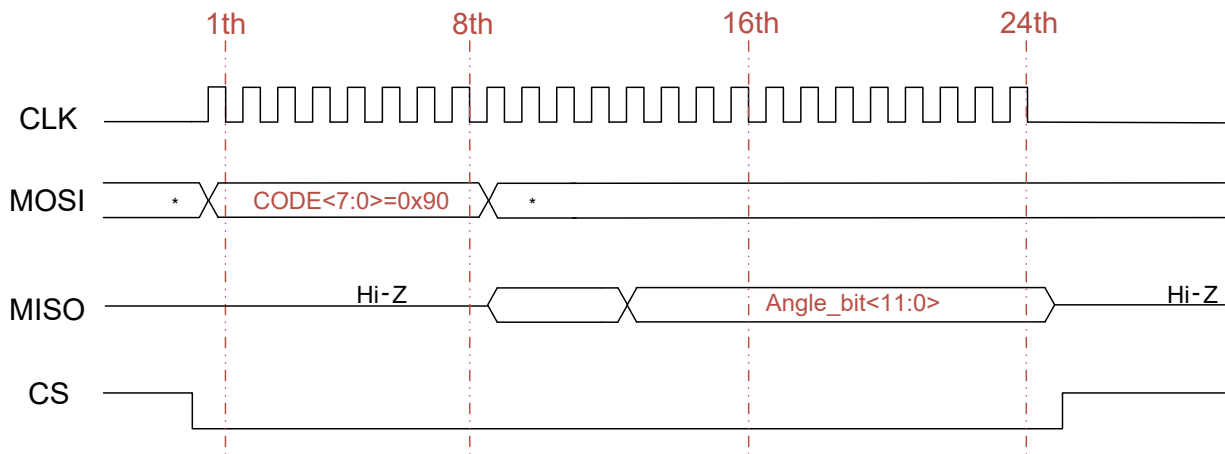

Figure 4. SPI timing diagram in reading angular values

Opcode< 7:0 >= 0 × 90 (MSB first), angular value output < 11:0 > (MSB first)

For AMR3108AP-1-X-YYZZ, the absolute angular value  $\theta$  in 0° to 360° can be calculated by:

$$\theta = \frac{\sum_{i=0}^{11} 2^{Angle<i>} }{4096} \times 360^{\circ}$$

For AMR3108AP-2-X-YYZZ, the absolute angular value  $\theta$  in 0° to 180° can be calculated by:

$$\theta = \frac{\sum_{i=0}^{11} 2^{Angle<i>} }{4096} \times 180^{\circ}$$

For AMR3108AP-3-X-YYZZ, the absolute angular value  $\theta$  in 0° to 180° can be calculated by:

$$\theta = \frac{\sum_{i=0}^{10} 2^{Angle<i>} }{2048} \times 180^{\circ}$$

## 10.2 ABZ output

AMR3108AP provides the incremental digital ABZ output through the A/B/Z pins. The A/B signals output interpolation factors can be programmed from 1 to 1024 pulses. Phase B precedes phase A when the magnet rotates counter-clockwise under the default settings as shown in Figure 5. The phase Z width is programmable in 1 LSB, 2 LSB, 4 LSB and 90° modes.

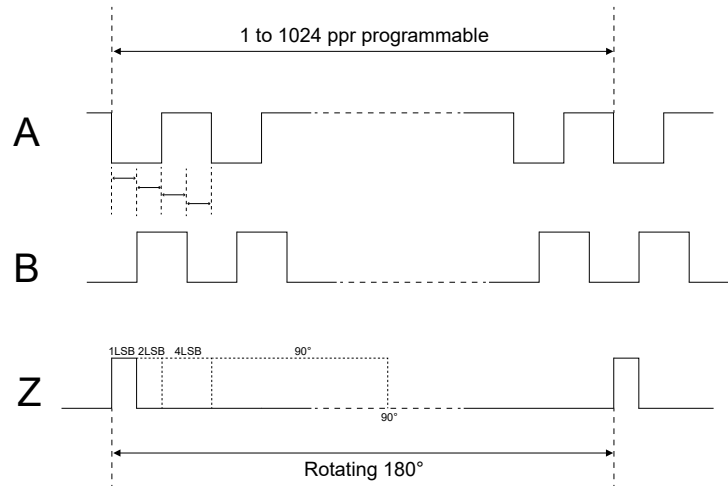

Figure 5. ABZ signal timing diagram

AMR3108AP is available in ABZ differential mode through output mode setting. A-/B-/Z- pins multiplex U/V/W pins.

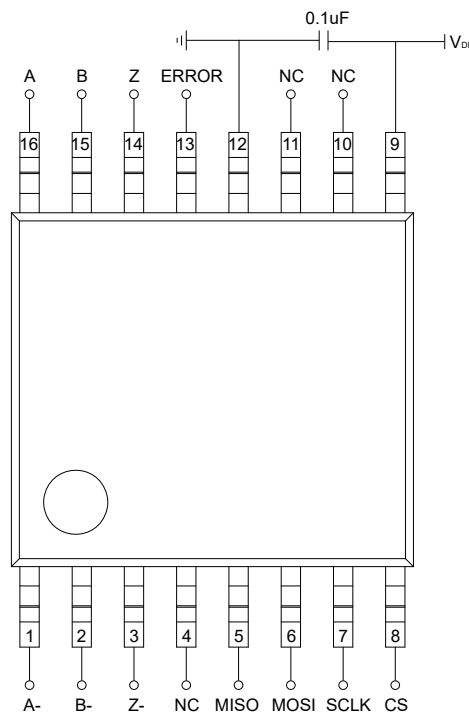

Figure 6. Schematic circuit of ABZ mode

The xMR310X calibration kit and corresponding host computer software is provided for the convenience of customer calibration and settings. The parameters settings for the zero position (phase Z), width of phase Z, hysteresis parameters, PPR parameters, and CW/CCW setup of AMR3108AP sensor can be performed by this xMR310X calibration kit.

### 10.3 UVW output

AMR3108AP provides UVW commutation output signals with a phase difference of 1/3 cycle between each other for detecting brushless DC motors. AMR3108AP is available in UVW mode through output mode setting, and the pole-pair quantity is programmable in 1 to 16 as shown in Figure 7. The schematic circuit of UVW mode is shown in Figure 8.

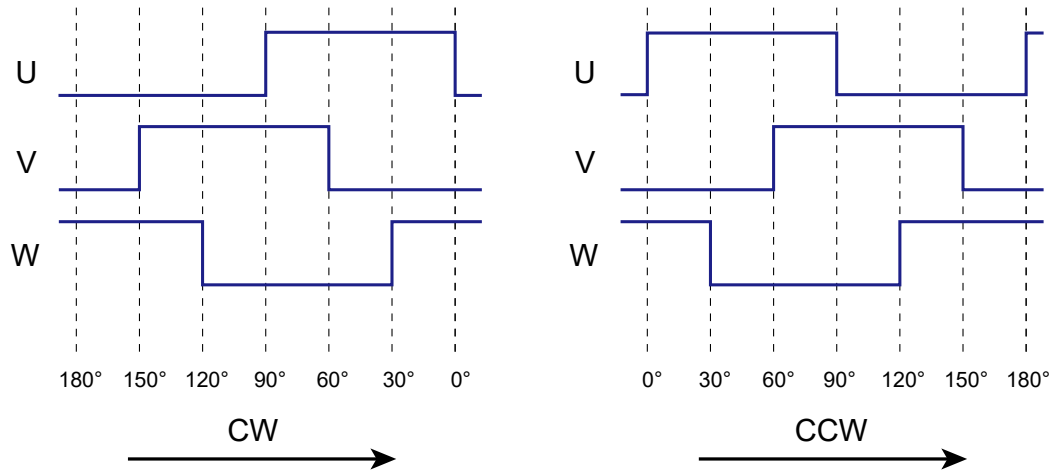

Figure 7. UVW output diagram

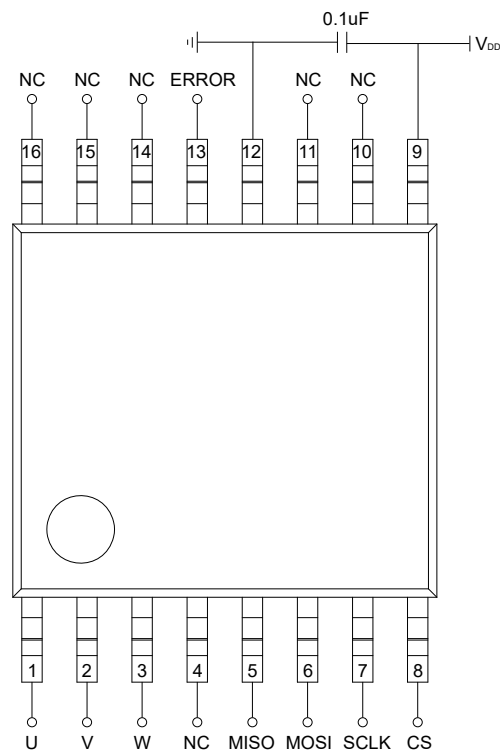

Figure 8. Schematic circuit of UVW mode

The xMR310X calibration kit and corresponding host computer software is provided for the convenience of customer calibration and settings. The UVW pole-pair quantity of AMR3108AP sensor can be set by this xMR310X calibration kit.

### 10.4 Analog output

AMR3108AP integrates a 12-bit ADC to convert absolute angle to linear analog output. The output mode needs to be programmed to be an analog voltage output as shown in Figure 9.

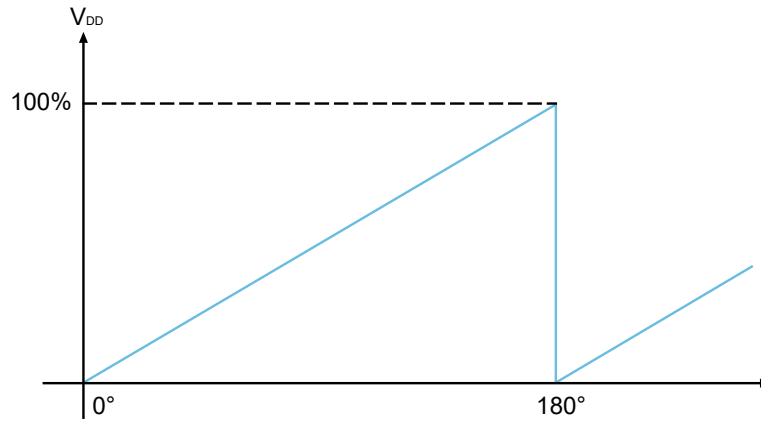

Figure 9. Waveform of analog output

It is recommended to connect an external decoupling capacitor C1 (typical value 10 nF, maximum 100 nF) and pull-up resistor R1 (typical value 10 k $\Omega$ ) for analog output circuit to obtain better performance.

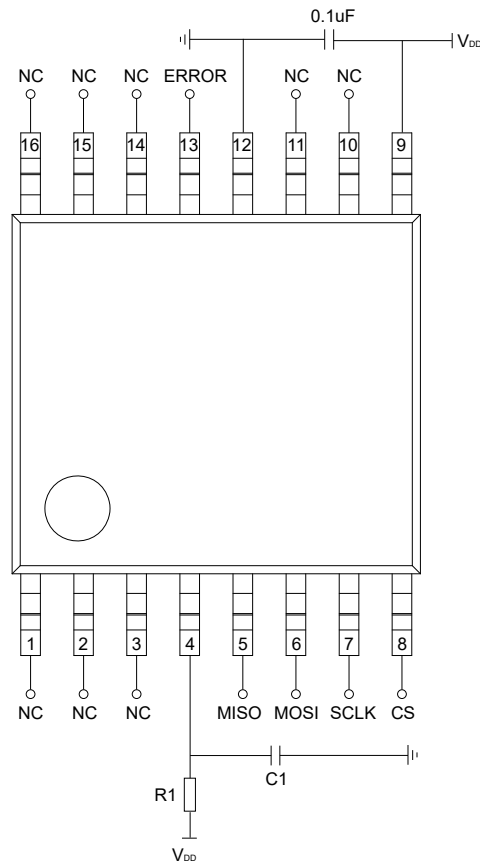

Figure 10. Schematic circuit of analog mode

The high clamping voltage (Clamp\_High) and low clamping voltage (Clamp\_Low) of analog output characteristic curves are both programmable as shown in Figure 11.

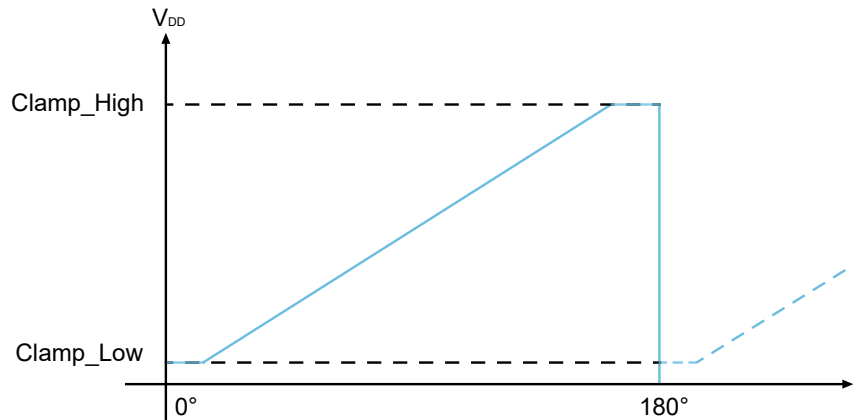

Figure 11. Schematic of clamping voltage in analog waveform

The xMR310X calibration kit and corresponding host computer software is provided for the convenience of customer calibration and settings. The clamping voltage in analog mode of AMR3108AP sensor can be set by this xMR310X calibration kit.

### 10.5 PWM output

AMR3108AP supports pulse width modulation (PWM) output. The duty cycle of PWM is a logic signal which proportional to the magnetic field angle. The duty cycle is limited by the minimum value (1/4096 of the period) and the maximum value (4095/4096 of the period), so the duty cycle varies from 1/4096 to 4095/4096 with the resolution of 12-bits. Figure 12 shows one period of the PWM signal, and the period (T) is  $1/F_{PWM}$ .

$F_{PWM}$  supports 1.08 kHz, 0.54 kHz, 0.27 kHz, and 0.135 kHz these four frequencies.

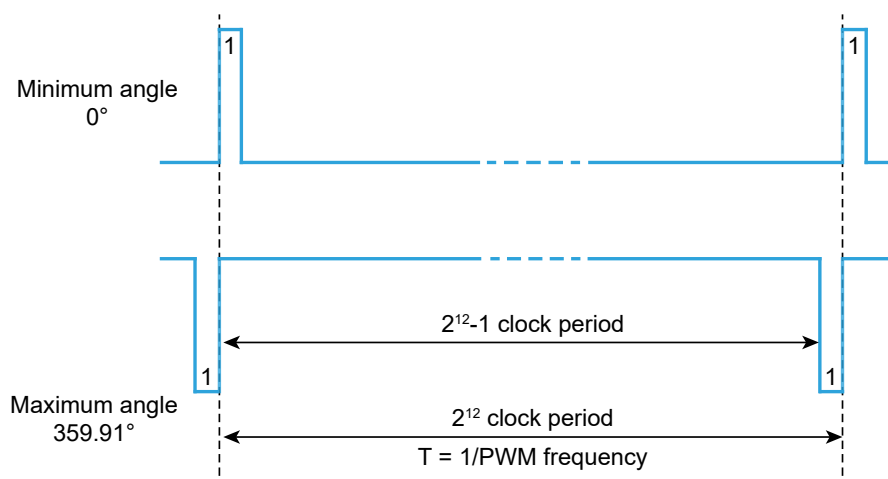

Figure 12. Waveform of PWM mode output signal

The xMR310X calibration kit and corresponding host computer software is provided for the convenience of customer calibration and settings. The PWM frequency of AMR3108AP sensor can be set by this xMR310X calibration kit.

## 11. Mechanical Angle Orientation

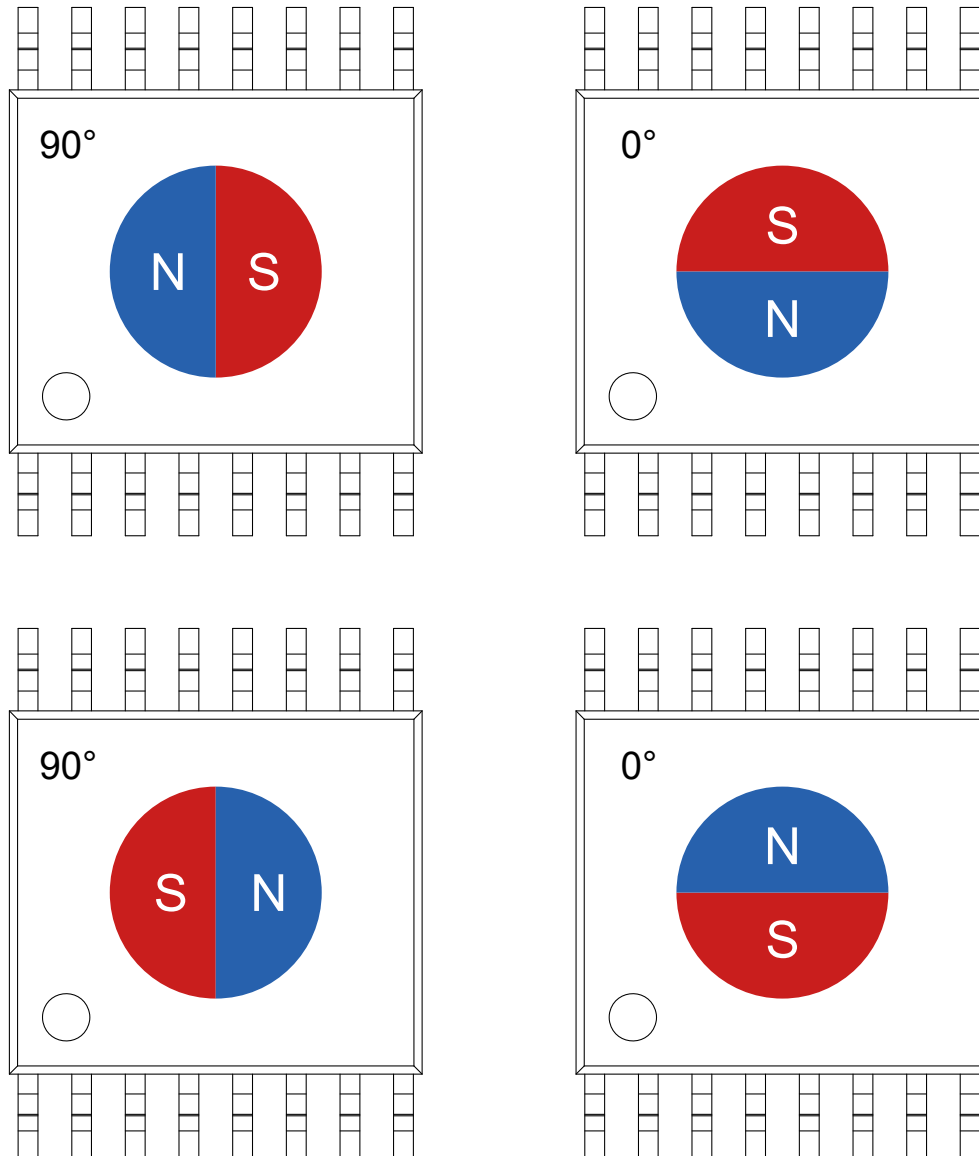

Figure 13. Definition of the magnetic field orientation measured by AMR3108AP

## 12. Dimensions

### TSSOP16 Package

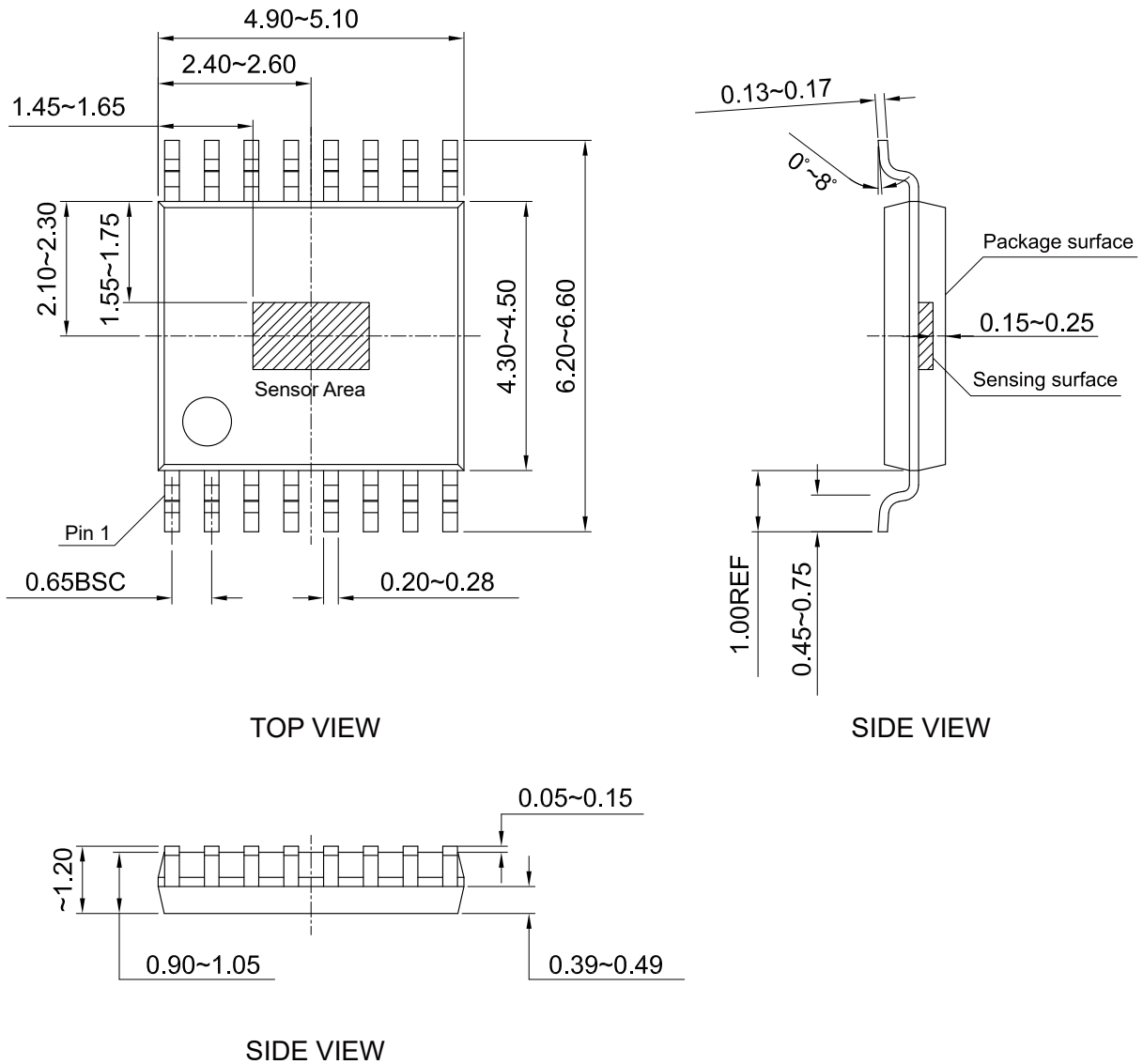

Figure 14. Package outline of TSSOP16 (unit: mm)

## Copyright © 2022 by MultiDimension Technology Co., Ltd.

Information furnished herein by MultiDimension Technology Co., Ltd. (hereinafter MDT) is believed to be accurate and reliable. However, MDT disclaims any and all warranties and liabilities of any kind, with respect to any examples, hints or any performance or use of technical data as described herein and/or any information regarding the application of the product, including without limitation warranties of non-infringement of intellectual property rights of any third party. This document neither conveys nor implies any license under patent or other industrial or intellectual property rights. Customer or any third-party must further determine the suitability of the MDT products for its applications to avoid the applications default of customer or third-party. MDT accept no liability in this respect.

MDT does not assume any liabilities of any indirect, incidental, punitive, special or consequential damages (including without limitation of lost profits, lost savings, business interruption, costs related to the removal or replacement of any products or rework charges) whether or not such damages are based on tort (including negligence), warranty, breach of contract or any other legal theory. Notwithstanding any damages that customer might incur for any reason whatsoever, MDT's aggregate and cumulative liability towards customer for the products described herein shall be limited in accordance with the terms and conditions of commercial sale of MDT.

Absolute maximum ratings are the extreme limits the device will withstand without damage to the MDT product. However, the electrical and mechanical characteristics are not guaranteed as the maximum limits (above recommended operating conditions) are approached. MDT disclaims any and all warranties and liabilities of the MDT product will operate at absolute maximum ratings.

Specifications may change without notice.

Please download latest document from our official website [www.dowaytech.com/en](http://www.dowaytech.com/en).

## Recycling

The product(s) in this document need to be handed over to a qualified solid waste management services company for recycling in accordance with relevant regulations on waste classification after the end of the product(s) life.



No.2 Guangdong Road, Zhangjiagang Free Trade Zone, Jiangsu, China

Web: [www.dowaytech.com/en](http://www.dowaytech.com/en) E-mail: [info@dowaytech.com](mailto:info@dowaytech.com)

