

Advanced Monolithic Systems

AMS04/AMS05

VOLTAGE REFERENCES

FEATURES

- Low Temperature Coefficient
- Wide Operating Current Range
 - AMS04.....15 μ A to 20mA
 - AMS05.....20 μ A to 20mA
- Max. 1 Ω Dynamic Impedance
- Typ. 2% Output tolerance

APPLICATIONS

- Battery Powered Systems
- Instrumentation
- A/D, D/A Converters
- Current sources
- Power Supplies
- Telecommunication

GENERAL DESCRIPTION

The AMS04 and the AMS05 are two-terminal, band-gap voltage reference diodes, with an output voltage of 1.25V for the AMS04 and 2.5V for the AMS05. These devices feature low dynamic impedance and good temperature coefficient, operating over a wide current range. Since the band-gap reference of these devices uses only transistors and resistors, low noise and good long term stability result. The wide dynamic operating range allows its use with widely varying supplies with excellent regulation. The AMS04 and AMS05 can be used for portable meters, regulators, data acquisition converters and telecommunication.

The AMS04 and AMS05 are operational over a temperature range of 0°C to 70°C and are available in TO-92 and SO-8 packages.

ORDERING INFORMATION:

MAX. TEMPCO	PACKAGE TYPE		OPERATING TEMPERATURE RANGE
	TO-92	8 LEAD SOIC	
50ppm/°C	AMS04AN	AMS04AS	0 to 70°C
100ppm/°C	AMS04BN	AMS04BS	0 to 70°C
50ppm/°C	AMS05AN	AMS05AS	0 to 70°C
100ppm/°C	AMS05BN	AMS05BS	0 to 70°C

PIN CONNECTIONS

TO-92
Plastic Package (N)

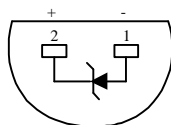

Bottom View

SO-8
SO Package (S)

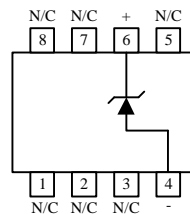

Top View

ABSOLUTE MAXIMUM RATINGS

Reverse Current	30mA	Soldering information	
Forward Current	10mA	TO-92 package: 10 sec.	260°C
Operating Temperature Range	0°C to 70°C	SOIC package: Vapor phase (60 sec)	215°C
Storage temperature	-55°C to +150°C	Infrared (15 sec.)	220°C

ELECTRICAL CHARACTERISTICS

Electrical Characteristics at $I_R = 100 \mu A$, and $T_A = +25^\circ C$ unless otherwise specified.

Parameter	Conditions	AMS04			AMS05			Units
		Min	Typ	Max	Min	Typ	Max	
Reverse Breakdown Voltage	$I_R = 100 \mu A$	1.235	1.250	1.265	2.475	2.50	2.525	V
Reverse Dynamic Impedance	$I_R = 100 \mu A$			1			1	Ω
Reverse Breakdown Voltage Change	$15 \mu A \leq I_R \leq 20 mA$		10	20				mV
	$20 \mu A \leq I_R \leq 1 mA$		0.25	1.0				mV
Min. Operating Current	$20 \mu A \leq I_R \leq 20 mA$					10	2.0	mV
	$25 \mu A \leq I_R \leq 1 mA$					0.25	1.0	mV
Min. Operating Current				10			20	μA
Wide Band Noise	$10 Hz \leq f \leq 10 kHz$		60			60		μV
Temperature Coeff. AMS04A/AMS05A	$I_R = 100 \mu A$ (Note 3)			50			50	ppm/°C
AMS04B/AMS05B				100			100	

Note 1: Absolute Maximum Ratings indicate limits beyond which damage to the device may occur. Operating Ratings indicate conditions for which the device is intended to be functional, but do not guarantee specific performance limits. For guaranteed specifications and test conditions, see the Electrical Characteristics. The guaranteed specifications apply only for the test conditions listed.

Note 2: For elevated temperature operation, T_j max is $+100^\circ C$

Thermal Resistance	TO-92	SO-8
θ_{JA} (junction to ambient)	170°C/W (0.125" leads)	165°C/W

Note 3: The average temperature coefficient is defined as the maximum deviation of reference voltage at all measured temperatures between the operating T_{MAX} and T_{MIN} , divided by $T_{MAX} - T_{MIN}$. The measured temperatures are $0^\circ C$, $25^\circ C$ and $70^\circ C$.

TYPICAL APPLICATIONS

Precision Current Source

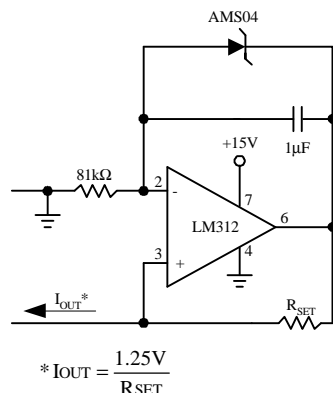

Battery Powered 1.25V Reference

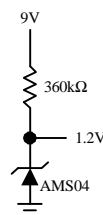

10V Reference

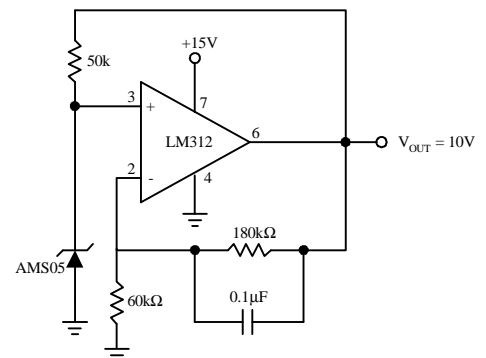

TYPICAL PERFORMANCE CHARACTERISTICS

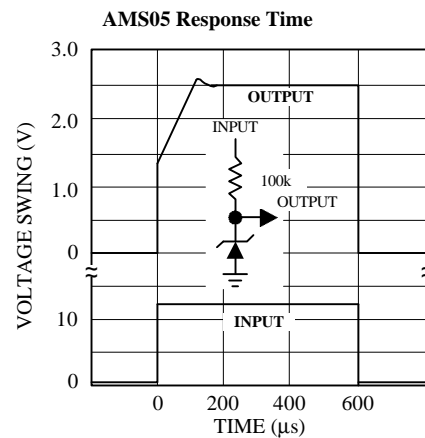
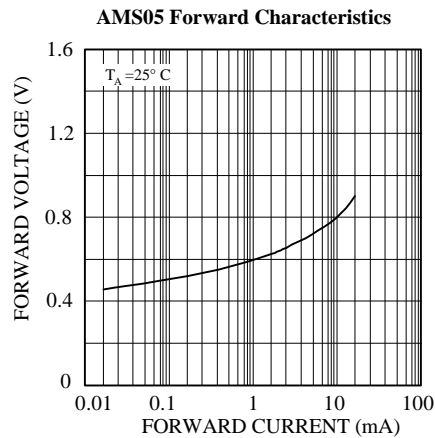
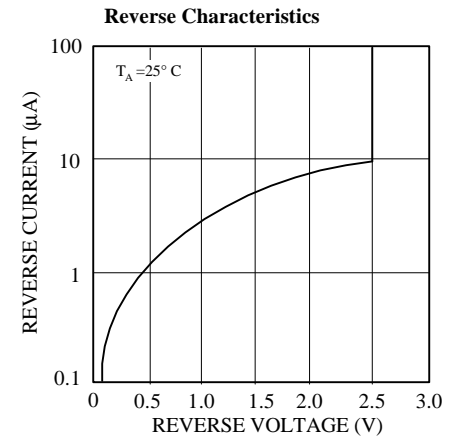
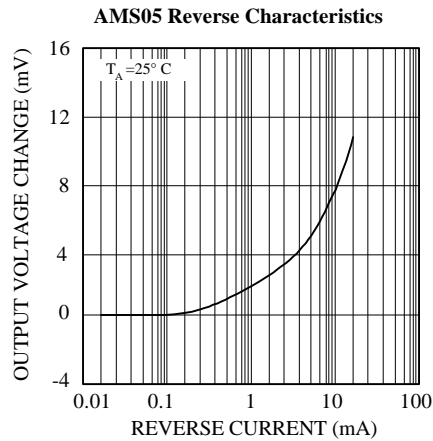
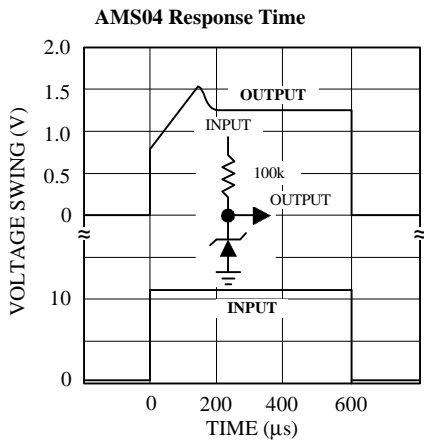
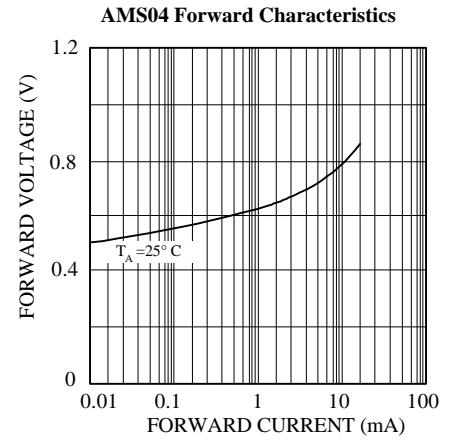
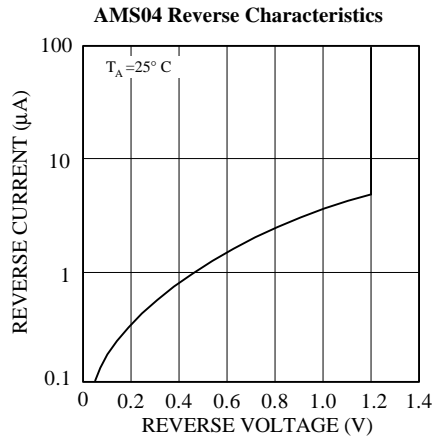
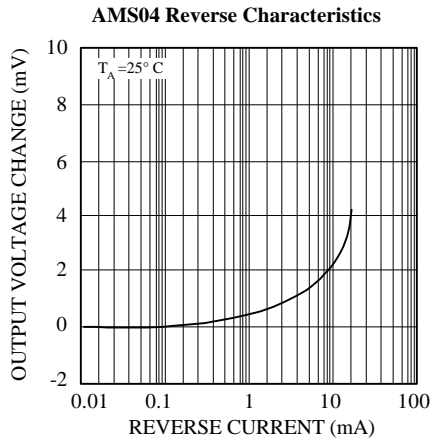

PACKAGE DIMENSIONS inches (millimeters) unless otherwise noted.

3 LEAD TO-92 PLASTIC PACKAGE (N)

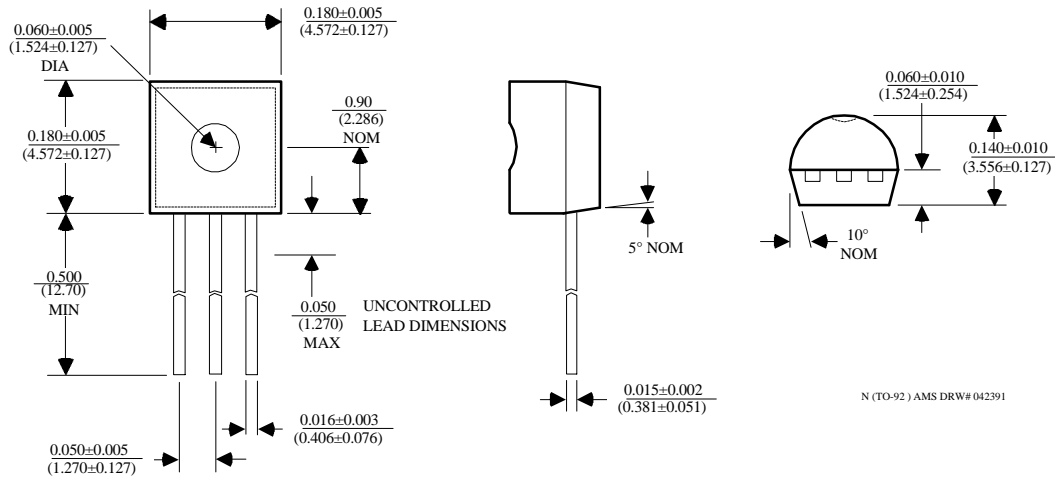

8 LEAD SOIC PLASTIC PACKAGE (S)

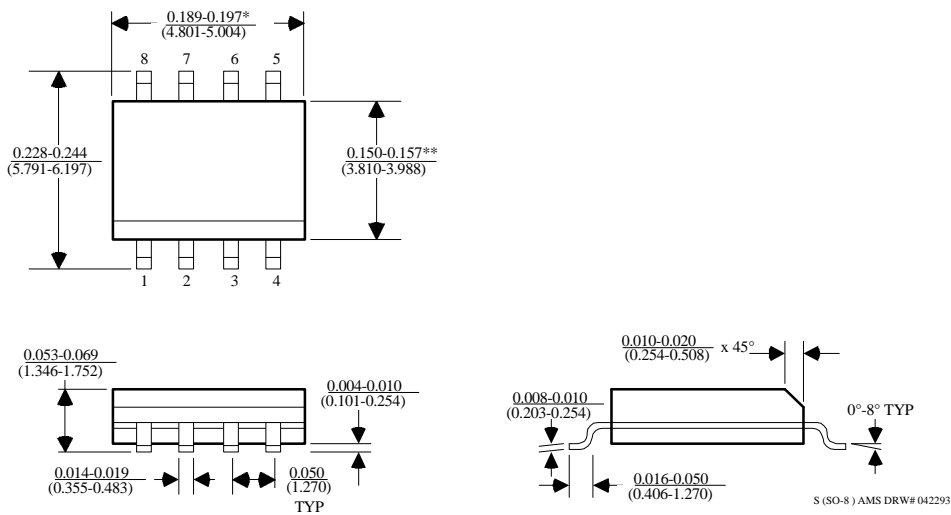

*DIMENSION DOES NOT INCLUDE MOLD FLASH. MOLD FLASH SHALL NOT EXCEED 0.006" (0.152mm) PER SIDE

**DIMENSION DOES NOT INCLUDE INTERLEAD FLASH. INTERLEAD FLASH SHALL NOT EXCEED 0.010" (0.254mm) PER SIDE