

FEATURES

- Low-Cost, Oscillator/Clock Generator
- Simple User Programming
- Output frequency programmable from 10 kHz to 6MHz
- 2.7 to 15V Single-Supply Operation
- Output frequency tolerance <1%
- Complementary output signal
- Break before make output signal

APPLICATIONS

- Switch-Mode Power Supplies
- Servers
- Printers
- Embedded Microcontrollers
- Industrial Controls
- Automotive Applications
- Toys

GENERAL DESCRIPTION

The AMS222 is a low-cost, oscillator intended to be used as an external clock for low-frequency applications. The device consists of a resistor-programmed oscillator with complementary output stage. An external resistor allows for output frequency range to be adjusted from 10kHz to 6MHz. The complimentary output stage is very useful in paralleling, switching regulators for doubling the output current. AMS222 is offered in SOT-23 5-leads package.

ORDERING INFORMATION:

MAX. OFFSET	PACKAGE TYPE	OPERATING TEMP. RANGE
	5 LEAD SOT-23	
15mV	AMS222AM1	-40 to +125°C

PIN CONNECTIONS

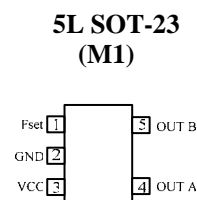

Top View

TYPICAL APPLICATION

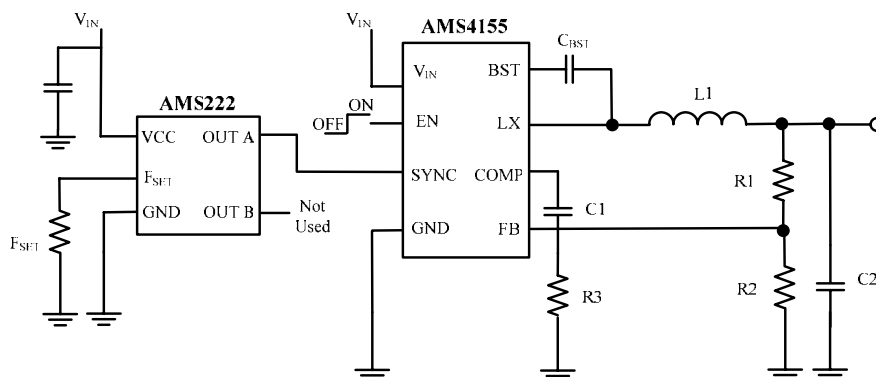

AMS222 used to SYNC. AMS4155 to >400KHz

ABSOLUTE MAXIMUM RATINGS (Note 1)

Voltage Range on VCC	-0.5V to +16V	Operating Temperature Range	-40°C to +125°C
		Storage Temperature Range	-55°C to +125°C

Stresses beyond those listed under “Absolute Maximum Ratings” may cause permanent damage to the device. These are stress ratings only, and functional operation of the device at these or any other conditions beyond those indicated in the operational sections of the specifications is not implied. Exposure to absolute maximum rating conditions for extended periods may affect device reliability.

DC ELECTRICAL CHARACTERISTICS

Electrical Characteristics at $T_A = -40^\circ\text{C}$ to $+125^\circ\text{C}$ and $V_{CC} = +3.0\text{C}$ to 5.5V unless otherwise noted.

PARAMETER	CONDITIONS	AMS222			Units
		Min.	Typ.	Max.	
Supply Current	$C_L = 15\text{pF}$, $V_{CC} = 3.3\text{V}$, $R_{SET} = 12.5\text{K}\Omega$ $C_L = 15\text{pF}$, $V_{CC} = 5.5\text{V}$, $R_{SET} = 12.5\text{K}\Omega$		1.0 1.0	1.2 1.5	mA
High-Level Output Voltage (OUT)	$I_{OH} = -1.5\text{mA}$ $V_{CC} = 3.3\text{V}$	2.5V			V
Low-Level Output Voltage (OUT)	$I_{OH} = -1.5\text{mA}$			0.4	V

AC ELECTRICAL CHARACTERISTICS

Electrical Characteristics at $T_A = -40^\circ\text{C}$ to $+125^\circ\text{C}$ and $V_{CC} = +3.0\text{C}$ to 5.5V unless otherwise noted.

PARAMETER	CONDITIONS	AMS222			Units
		Min.	Typ.	Max.	
Output Frequency Tolerance	$V_{CC} = 3.3\text{V}$, $T_A = +25^\circ\text{C}$	-1.0		+1.0	%
Voltage Frequency Variation	$T_A = +25^\circ\text{C}$, $R_{SET} = 12.5\text{K}\Omega$ $V_{CC} = 3.3\text{V}$ to 5.0V (Note 2)	-0.25		+0.25	%
	$T_A = +25^\circ\text{C}$, $R_{SET} = 12.5\text{K}\Omega$ $V_{CC} = 5.0\text{V}$ to 10V (Notes 2)	-0.5		+0.5	
Temperature Frequency Variation	$V_{CC} = 3.3\text{V}$ (Note 3)	-2.0		+2.0	%
Load Capacitance	(Note 4)			30	pF
Output Duty Cycle	10kHz to 1MHz, $T_A = +25^\circ\text{C}$ (Note 3)	48	49.5		%
	1MHz to 2 MHz (Note 4)	46	48		
Output Rise/Fall Time	$C_L = 15\text{pF}$, $V_{CC} = 3.3\text{V}$		20	30	ns

Note 1: All voltage referenced to ground.

Note 2: This is the change observed in output frequency due to changes in voltage.

Note 3: Parameter is guaranteed by design and is not production tested.

Note 4: Output voltage swings can be impaired at high frequencies combined with high output loading.

TYPICAL CHARACTERISTICS

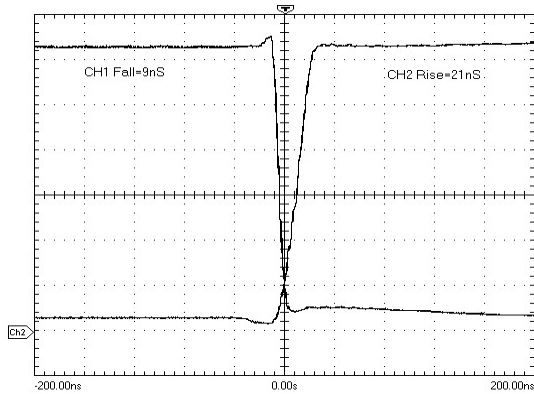

Channel 2 Rise and Channel 1 Fall Time @ VCC = 3.3V, C1 = 15pF

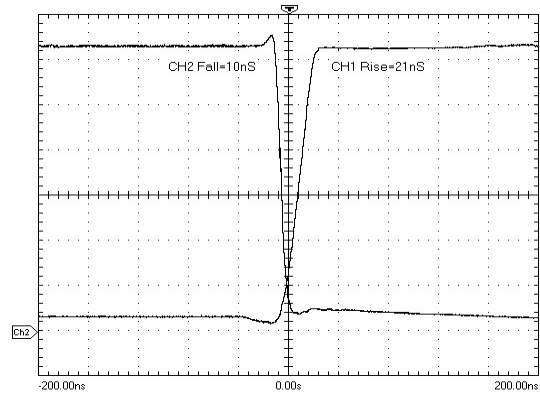

Channel 1 Rise and Channel 2 Fall Time @ VCC = 3.3V, C1 = 15pF

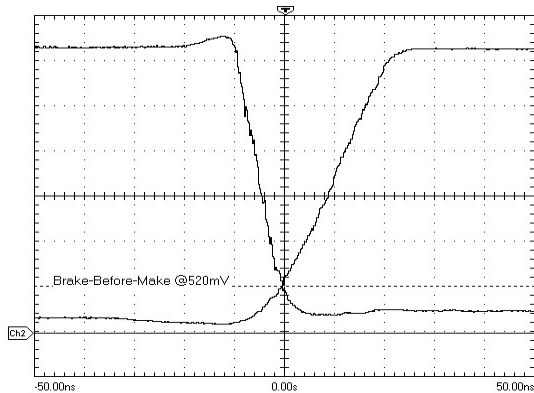

Break before make Approximate 520mV @ VCC= 3.3V, C1= 15pF

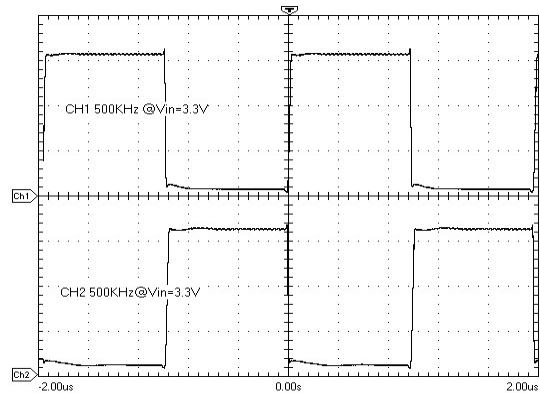

Channel 1 and 2 Waveform @ 500 KHz, VCC= 3.3V, C1= 15pF

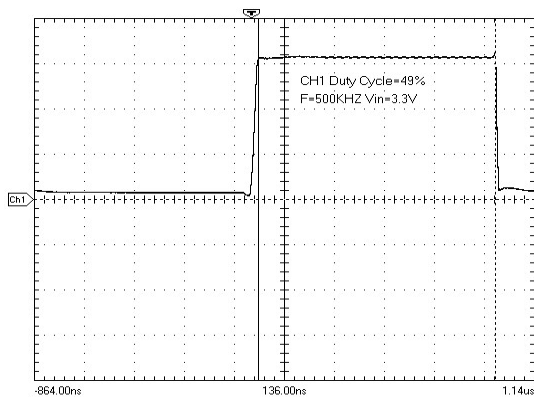

Channel 1 Duty Cycle @ VCC= 3.3V, C1= 15pF

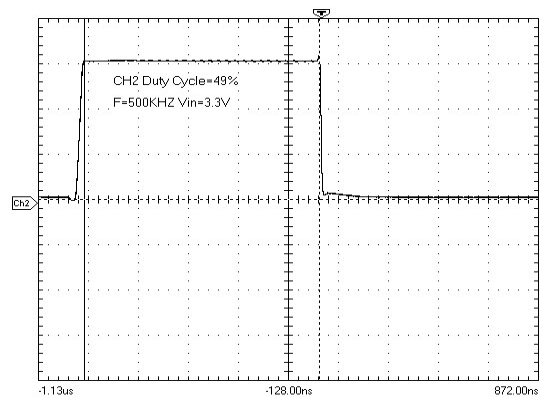

Channel 2 Duty Cycle @ VCC= 3.3V, C1= 15pF

TYPICAL CHARACTERISTICS (continued)

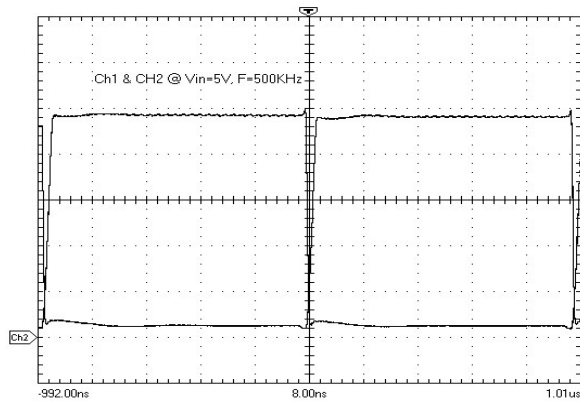

Channel 1 and Channel 2 Waveform @ VCC = 5V, C1= 15pF

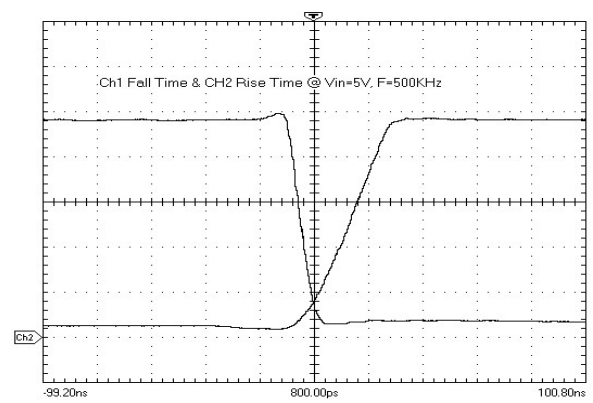

VCC= 5.0V, C1 = 15pF
Channel 1 Fall Time
Channel 2 Rise Time

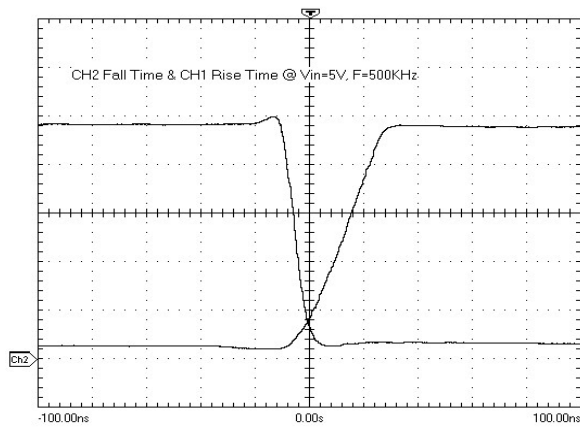

VCC = 5.0V, C1= 15pF
Channel 2 Fall Time
Channel 1 Rise Time

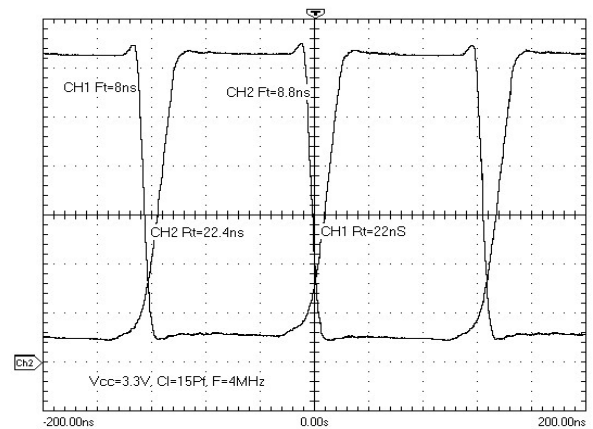

Waveform @ 4MHz and VCC= 3.3V (vertical scale 500mV/div)

TYPICAL CHARACTERISTICS (continued)

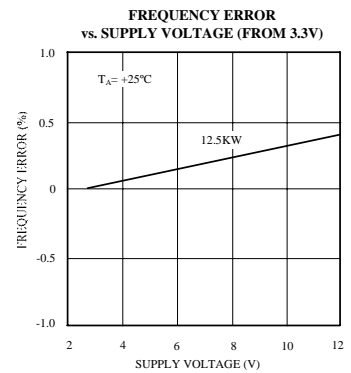
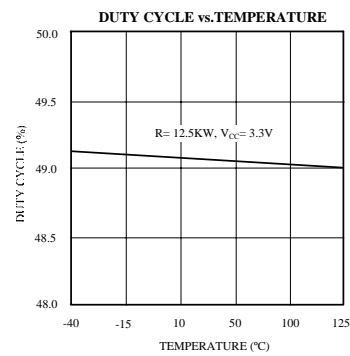
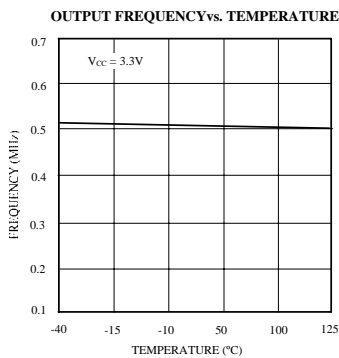
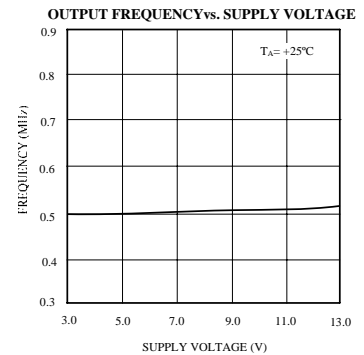
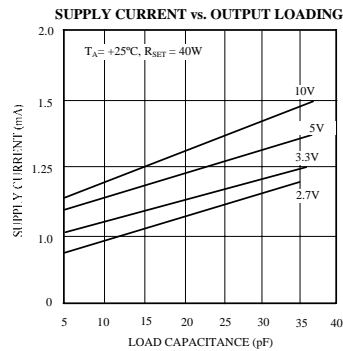
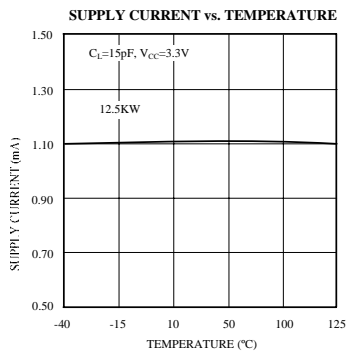
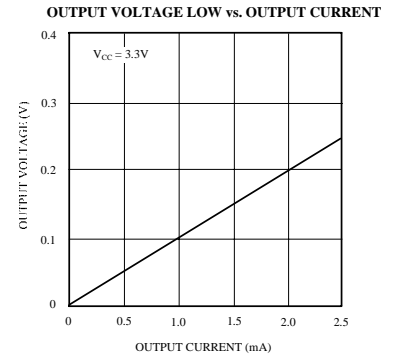
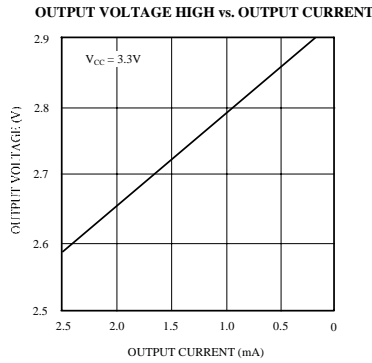
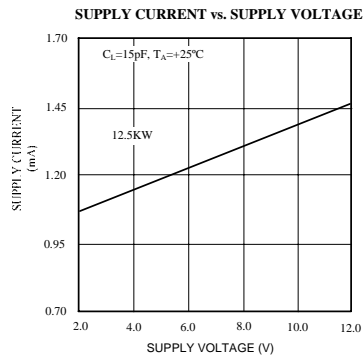

TYPICAL CHARACTERISTICS (continued)

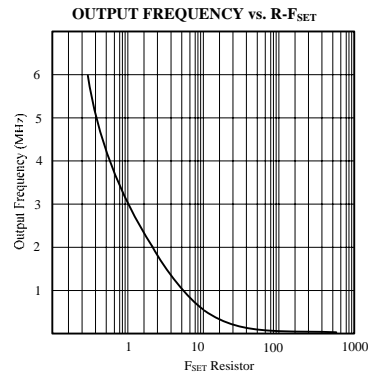
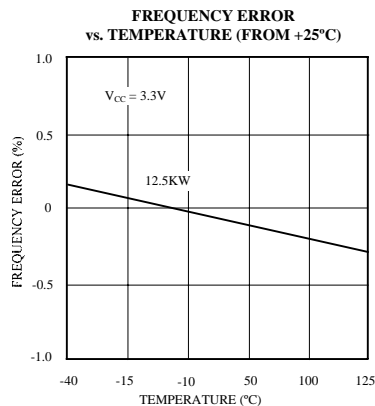

PRODUCT DESCRIPTION

AMS222 is a silicon clock generator with complementary output, programmable frequency using a single resistor from 10KHz to 6MHz.

The Output B is 180° phase from Output A, and the signals do not overlap does allow to drive critical circuits where break-before-make is very important. It operates from as low as 2.7V to high 15V consuming just 1.2mA of power. The output drive is capable to drive capacitive loads up to 50pF and resistive loads up to 3mA. The high stability of the output frequency and it's immunity to supply variation is due to internal temperature compensated voltage reference. Having a good power supply rejection ratio, the device works very well in electrically noisy environments. The only critical element is the Fset resistor that should be placed as close as possible to the package to avoid parasitic capacitance and PCB traces cross-talk.

TYPICAL APPLICATION CIRCUIT

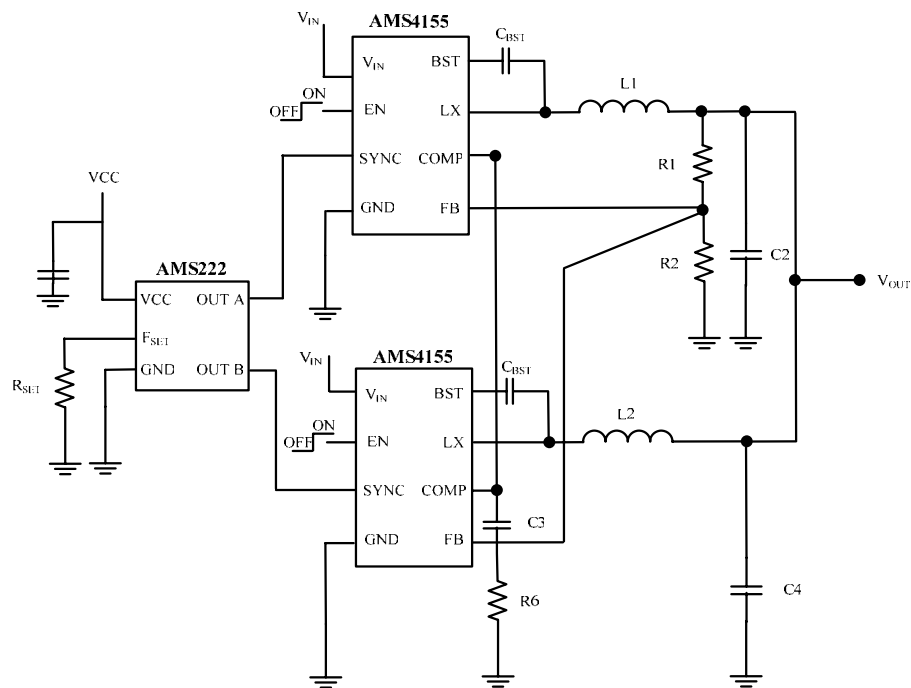

AMS222 used as Clock Signal to Synchronize two Switching Regulators

PACKAGE DIMENSIONS inches (millimeters) unless otherwise noted.

5 LEAD SOT-23 PLASTIC PACKAGE (M1)

