

**Cadmium-free sensor
with spectral response**
The Through-hole Type for easy
implementation as a CdS cell replacement

LIGHT SENSOR

NaPiCa

• SMD type



L 2.0mm .079inch
W 3.2mm .126inch
H 1.0mm .039inch

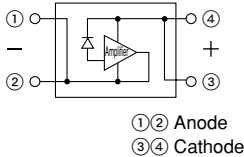

www.DataSheet4U.com

• Through-hole type

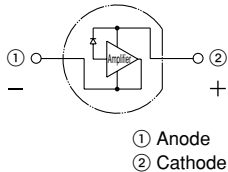
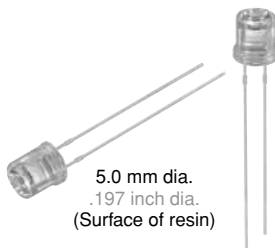

FEATURES

1. Built-in optical filter for spectral response similar to that of the human eye.

Peak sensitivity wavelength is 580 nm

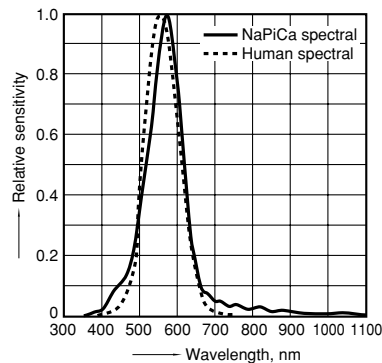

2. Photocurrent is proportional to illumination. (linear output)

High photocurrent is achieved by built-in photocurrent amp.

$I_L = 260 \mu A$ (typical)

$E_v = 100 \text{ lx}$ (fluorescent light)

3. Uses environmentally friendly silicon chips.

4. Lead-free.

5. Operates on 1.5 to 6 V DC, which is suitable for battery operation.

6. Compact, SMD package

Same through-hole shape as CdS cell.

TYPICAL APPLICATIONS

1. Brightness detection for LCD backlight control for LCD devices (mobile phones, LCD TVs, car navigation systems, mobile PCs, and PDAs).

2. Brightness detection for controlling the keypad backlight in mobile phones.

3. Brightness detection for circuits in household lighting, crime prevention lighting, and automatic lighting for bicycle.

4. Brightness detection for wall clocks (radio clocks).

RoHS Directive compatibility information
<http://www.nais-e.com/>

TYPES

Packing quantity: Tape and reel package SMD type: Inner 3,000 pcs., Outer 3,000 pcs.
Tape and reel package Through-hole type: Inner 2,000 pcs., Outer 2,000 pcs.
Baggage package Through-hole type: Inner 500 pcs., Outer 1,000 pcs.

| Photo current | Part No. | | |
|---------------|---|-----------------------|-----------------|
| | Tape and reel package | Tape and reel package | Baggage package |
| | SMD type (Picked from the 1/4-pin side) | Through-hole type | |
| 260 μA^* | AMS104Y | AMS302T | AMS302 |

Note*: $E_v = 100 \text{ lx}$ (Fluorescent lamp is used as light source)

Tape package is the standard packing style.

Please inquire if you need tape and reel packaging that allows the SMD type to be picked from the 2/3-pin side.

RATINGS

1. Absolute maximum ratings (Ambient temperature: 25°C 77°F)

| Item | Symbol | AMS104/AMS302 | Remarks |
|-----------------------|-----------|-----------------------------|------------------------------------|
| Reverse voltage | V_R | -0.5 to 8 V | |
| Photocurrent | I_L | 5 mA | |
| Power dissipation | P | 40 mW | |
| Operating temperature | T_{opr} | -30 to +85°C -22 to +185°F | Non-condensing at low temperatures |
| Storage temperature | T_{stg} | -40 to +100°C -40 to +176°F | Non-condensing at low temperatures |

2. Recommended operating condition

| Item | Symbol | AMS104/AMS302 | Remarks |
|-----------------|---------|---------------|---------|
| Reverse voltage | Minimum | 1.5 V | — |
| | Maximum | 6 V | |

3. Electrical and optical characteristics (Ambient temperature: 25°C 77°F)

| Item | | Symbol | AMS104/AMS302 | Condition |
|-----------------------------|-----------|-------------|--------------------|--|
| Peak sensitivity wavelength | — | λ_p | 580 nm | — |
| Photocurrent 1 | Minimum | I_{L1} | 9.1 μA | $V_R = 5\text{ V}$ $E_v = 5\text{ lx}^{*1}$ |
| | Typical | | 13 μA | |
| | Maximum | | 16.9 μA | |
| Photocurrent 2 | Minimum | I_{L2} | 182 μA | $V_R = 5\text{ V}$ $E_v = 100\text{ lx}^{*1}$ |
| | Typical | | 260 μA | |
| | Maximum | | 338 μA | |
| Photocurrent 3 | Typical | I_{L3} | 500 μA | $V_R = 5\text{ V}$ $E_v = 100\text{ lx}^{*2}$ |
| Dark current | Maximum | I_D | 0.3 μA | $V_R = 5\text{ V}$ |
| Switching time | Rise time | Typical | t_r | $V_R = 2.5\text{ V}$, $V_o = 2.5\text{ V}$ $R_L = 5\text{ k}\Omega$ |
| | Fall time | Typical | t_f | |

*1 Fluorescent lamp is used as light source. E_v = Brightness

*2 CIE standard illuminant 'A' is used as light source.

*3 Measuring method for switching time.

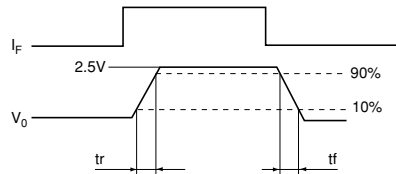
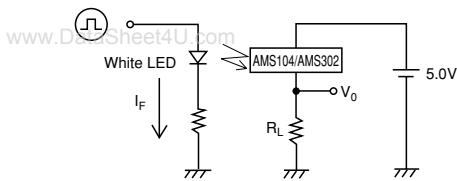

REFERENCE DATA

1. Power dissipation vs. ambient temperature characteristics

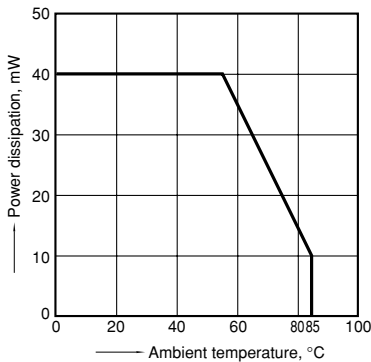

2. Relative sensitivity vs. wavelength characteristics

Ambient temperature: 25°C 77°F
Reverse voltage: 5V

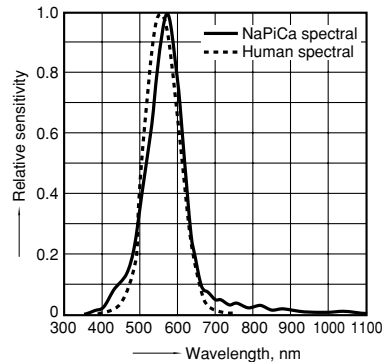

3. Dark current vs. ambient temperature characteristics

Reverse voltage: 5V

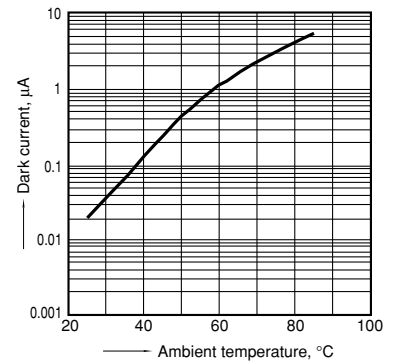

4. Photocurrent vs. brightness characteristics

Light source: Fluorescent lamp, CIE standard "A"
Reverse voltage: 5V, Ambient temperature: 25°C 77°F

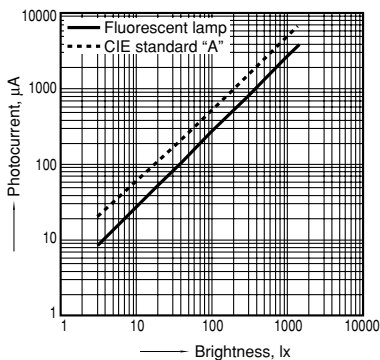

5. Relative photocurrent vs. ambient temperature characteristics

Light source: Fluorescent lamp, Brightness: 100 lx
Reverse voltage: 5V

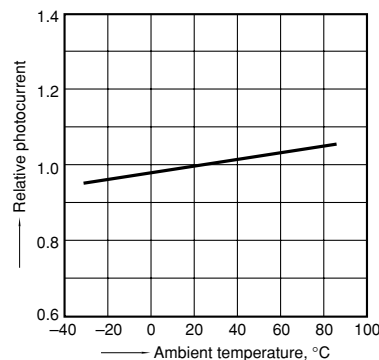

6. Relative photocurrent vs. reverse voltage characteristics

Light source: Fluorescent lamp, Brightness: 100 lx
Ambient temperature: 25°C 77°F

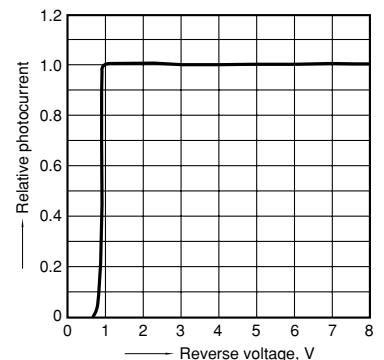

Light Sensor (AMS1, 3)

7. Switching time vs. resistive load characteristics

Light source: White LED, Reverse voltage: 2.5V
Resistive load voltage: 2.5V
Ambient temperature: 25°C 77°F

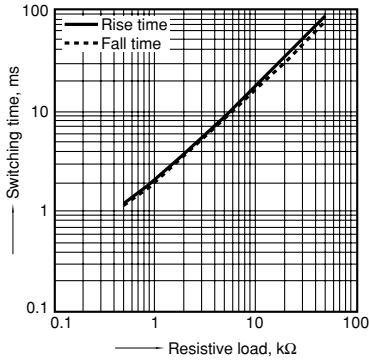

DIMENSIONS

mm inch

1. SMD type

www.DataSheet4U.com

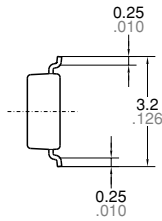
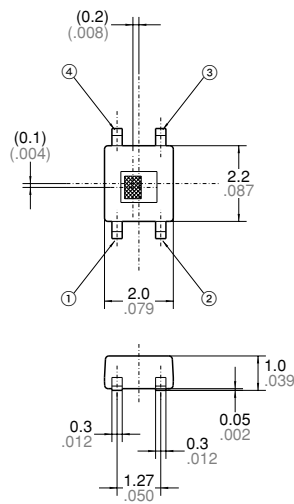

Recommended mounting pad (Top view)

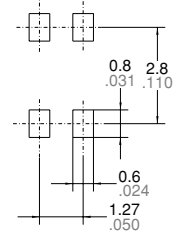

- ① Anode: -
- ② Anode: -
- ③ Cathode: +
- ④ Cathode: +
- DETECTION AREA

Terminal thickness: $t=0.125$
General Tolerance: $\pm 0.1 \pm 0.004$

Tolerance: $\pm 0.1 \pm 0.004$

2. Through-hole type

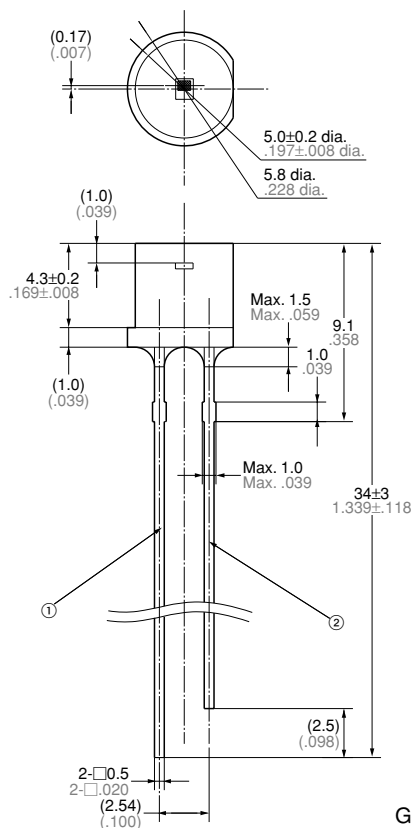
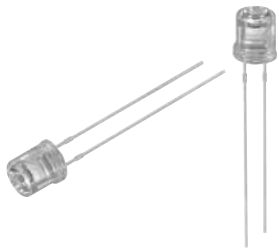

- ① Anode: -
- ② Cathode: +
- DETECTION AREA

General Tolerance: $\pm 0.5 \pm 0.020$

SAFETY PRECAUTIONS

Be sure to obey the following in order to prevent injuries and accidents.

- Do not use the sensors under conditions that exceed the range of its specifications. It may cause overheating, smoke, or fire.

- Connect terminals correctly by verifying the pin layout with the specifications diagram or other instructions. Erroneous connections may lead to unexpected operating errors, overheating, smoke, or fire.

- For an important and serious application in terms of safety, add protection circuit or any other protection method.

CAUTIONS FOR USE

1. Applying stress that exceeds the absolute maximum rating

If the voltage or current value for any of the terminals exceeds the absolute maximum rating, internal elements will deteriorate because of the excessive voltage or current. In extreme cases, wiring may melt, or silicon P/N junctions may be destroyed.

As a result, the design should ensure that the absolute maximum ratings will never be exceeded, even momentarily.

2. Deterioration and destruction caused by discharge of static electricity

This phenomenon is generally called static electricity destruction. Static electricity generated by various factors flows through the terminal and occurs to destroy internal elements. To prevent problems from static electricity, the following precautions and measures should be taken when using your device.

- 1) Employees handling sensor should wear anti-static clothing and should be grounded through protective resistance of 500 k Ω to 1 M Ω .
- 2) A conductive metal sheet should be placed over the work table. Measuring instruments and jigs should be grounded.
- 3) When using soldering irons, either use irons with low leakage current, or ground the tip of the soldering iron. (Use of low-voltage soldering irons is also recommended.)
- 4) Devices and equipment used in assembly should also be grounded.
- 5) When packing printed circuit boards and equipment, avoid using high-polymer materials such as foam styrene, plastic, and other materials which carry an electrostatic charge.
- 6) When storing or transporting sensor, the environment should not be generated static electricity (for instance, the humidity should be between 45 and 60%), and sensor should be protected using conductive packing materials.

3. Just after supplying voltage, please note that current in the sensor will be not constant until internal circuit stability.

4. Storage

The sensors are transparent plastic packages. They are sensitive to moisture and come in moisture-proof packages. Observe the following cautions when storing.

1) After the moisture-proof package is unsealed, take the sensors out of storage as soon as possible (within 1 week at the most).

2) If the devices are to be left in storage for a considerable period after the moisture-proof package has been unsealed, it is recommended to keep them in another moisture-proof bag containing silica gel (within 3 months at the most).

3) Storage under extreme conditions will cause soldering degradation, external appearance defects, and deterioration of the characteristics. The following storage conditions are recommended:

- Temperature: 0 to 30°C 32 to 86°F
- Humidity: Less than 60% R.H. (Avoid freezing and condensing)
- Atmosphere: No harmful gasses such as sulfuric acid gas, minimal dust.

*When mounting with solder, if thermal stress is applied to sensors that have absorbed moisture, the moisture will vaporize, swelling will occur, and the inside of the package will become stressed. This may cause the package surface to blister or crack. Therefore, please take caution and observe the soldering conditions in the following section.

5. Recommended soldering conditions

<SMD type>

- 1) Recommended condition
- (1) IR (Infrared reflow) soldering method

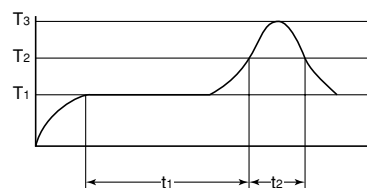

- T₁ = 155 to 180°C 311 to 356°F
- T₂ = 230°C 446°F
- T₃ = 250°C 482°F or less
- t₁ = 60 to 120 s or less
- t₂ = 30 s or less

(2) Soldering iron method

Tip temperature: 350 to 400°C 662 to 752°F

Wattage: 30 to 60 W

Soldering time: within 3 s

2) Do not do flow soldering.

<Through-hole type>

1) Recommended condition

(1) Double wave soldering method

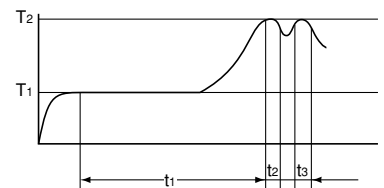

T₁ = 120°C 248°F

T₂ = 260°C 500°F or less

t₁ = 120 s or less

t₂+t₃ = 6 s or less

(2) Soldering iron method

Tip temperature: 350 to 400°C 662 to 752°F

Wattage: 30 to 60 W

Soldering time: within 3 s

2) The soldered position on leads should not be closer than 3mm .118inch to the molding resin of this sensor.

6. Notes for mounting

1) Temperature rise in the lead portion is highly dependent on package size.

If multiple different packages are mounted on the same board, please check your board beforehand in an actual product, ensuring that the temperature of the solder area of the sensor terminals falls within the temperature conditions of item 5.

2) If the mounting conditions exceed the recommended solder conditions in item 5, resin strength will fall and the mismatching of the heat expansion coefficient of each constituent material will increase markedly, possibly causing cracks in the package, disconnections of bonding wires, and the like. For this reason, please inquire with us about whether this use is possible.

Light Sensor (AMS1, 3)

7. Cleaning solvents compatibility

We recommend dip cleaning with an organic solvent for removal of solder flux etc. If you cannot avoid using ultrasonic cleansing, please ensure that the following conditions are met, and check beforehand for defects.

- Frequency: 27 to 29 kHz
- Ultrasonic power: No greater than 0.25W/cm²
- Cleaning time: No longer than 30 s
- Cleanser used: Asahiklin AK-225

• Other:

Submerge in solvent in order to prevent the PCB and sensors from being contacted directly by the ultrasonic vibrations.

Note: Applies to unit area ultrasonic power for ultrasonic baths.

8. Transportation

Extreme vibration during transport will warp the lead or damage the sensor. Handle the outer and inner boxes with care.

9. Avoid using the sensor in environments containing excessive amounts of steam, dust, corrosive gas, or where organic solvents are present.

10. Lead forming and cutting

- 1) Lead forming must be done at normal temperature before soldering
- 2) The bent and cut position on leads should not be closer than 3mm .118inch to the base of leads.
- 3) Lead forming and cutting must be done while fixing the base of leads.
- 4) Avoid mounting with stress at the base of leads.

11. The following shows the packaging format

1) SMD type tape and reel

mm inch

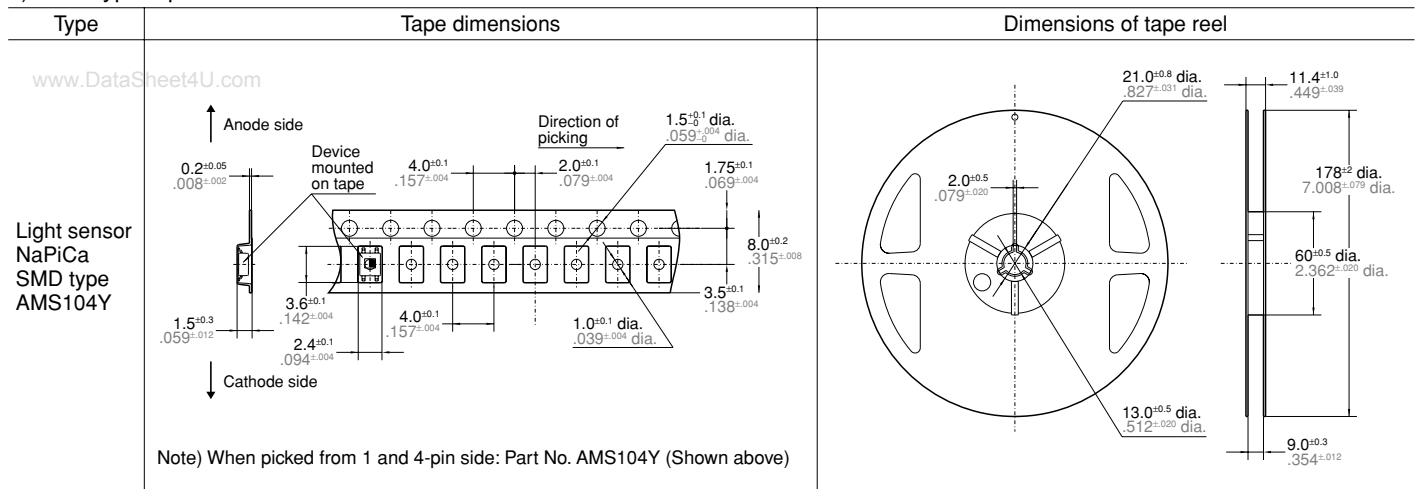

2) Through-hole type tape and reel

mm inch

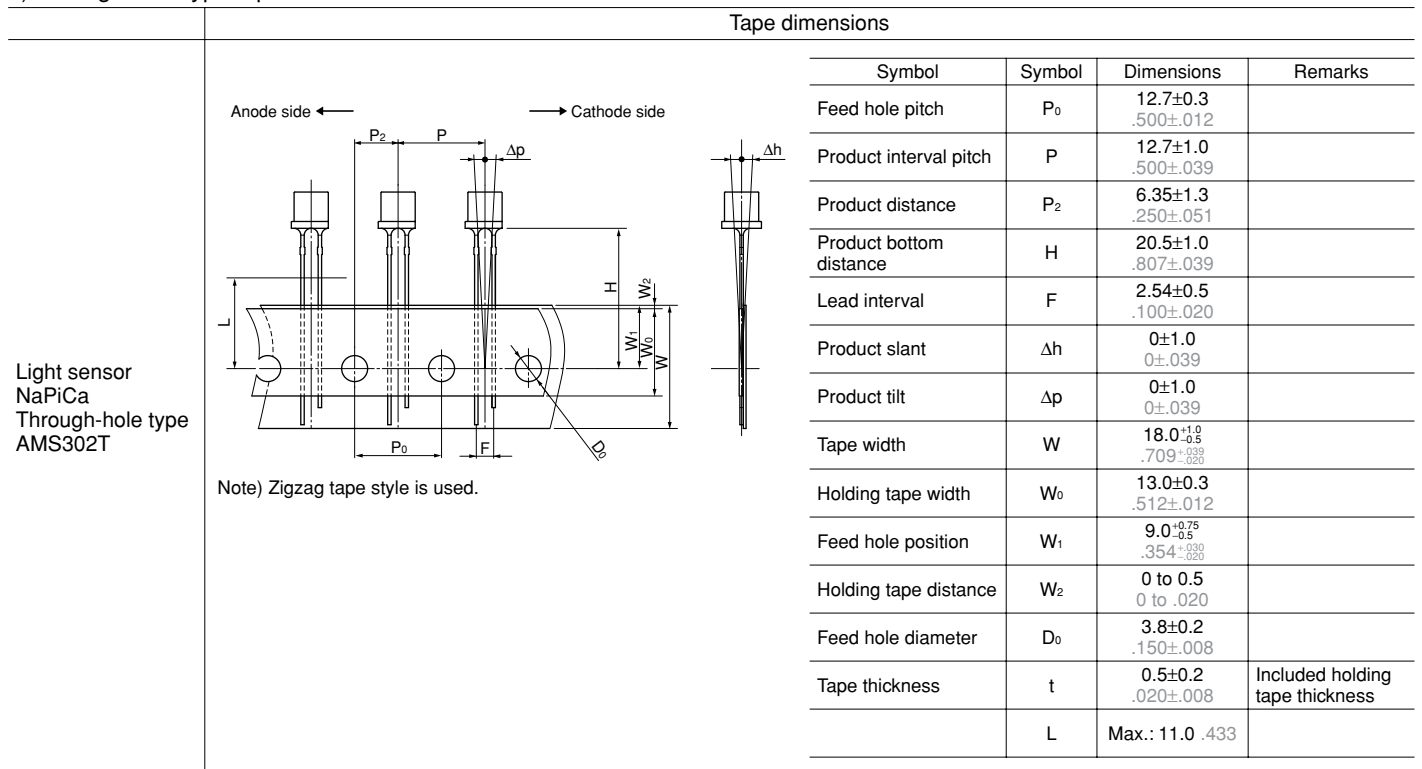

Light Sensor NaPiCa terminology

| Term | Symbol | Explanation |
|-----------------------------|-------------|--|
| Reverse voltage | V_R | The applied voltage between the cathode and anode. |
| Photocurrent | I_L | The current that flows between the cathode and anode when light is applied. |
| Power dissipation | P | The electric power loss that occurs between the cathode and anode. |
| Operating temperature | T_{opr} | The workable ambient temperature range at which normal operation is possible under the condition of a prescribed allowable loss. |
| Storage temperature | T_{stg} | The ambient temperature range at which the sensor can be left or stored without applying voltage. |
| Peak sensitivity wavelength | λ_p | The wavelength of light at which sensitivity is at its maximum. |
| Dark current | I_D | The current between the cathode and anode when reverse voltage is applied during darkness. |
| Rise time | t_r | Time required for the output waveform to rise from 10% to 90% when light is applied. |
| Fall time | t_f | Time required for the output waveform to fall from 90% to 10% when light is cut. |