

Speed & Position

# Sensors





Cherry sensors deliver unmatched performance and reliability to a broad range of OEM products.

At ZF Electronics GmbH, the owner of the Cherry brand, we specialize in economical sensors that are suitable for the most rigorous environments, including extremes of temperature, humidity, thermal shock and vibration. Choose a standard product, or partner with ZF Electronics design engineers as they help you to develop a custom solution.

Customers in the heavy truck, off highway, recreational vehicle, appliance, automotive and medical markets all rely on Cherry sensors for practical designs and durable products.

## High-Performance Sensors for Demanding Environments

Cherry offers seven standard sensor product series:

- MP — Magnetic Position Sensors
- GS — Geartooth Speed Sensors
- SD — Geartooth Speed and Direction Sensors
- VN — Ferrous Vane Sensors
- AN — Angular Position Sensors
- AS — Magnetic Actuators and Mating Connectors



### Your Total Design Partner

When you need a custom sensor, Cherry provides the design expertise and development tools needed to bring your product to market quickly.

We focus on innovation within our core competencies of magnetics, packaging, electronic design, and sealing technologies to assure our customers reliable sensing solutions.

Consider a few of the capabilities Cherry can deliver to your next custom sensor project:

- Using a solid model design concept developed by the customer, Cherry design engineers apply 3D magnetic modeling to ensure appropriate airgaps and magnetic fields are designed in at the start of the project.
- When harsh environments are involved, Cherry recommends appropriate packaging and sealing technology. Our packaging innovations have resulted in sensors that perform under extreme conditions: temperatures up to 150°C, immersion in solvents to IP68, and exposure to salt spray, dust, gravel and repeated thermal shock.
- With Cherry's in-house stereolithography and prototype line, we can quickly provide a highly engineered design.

- We match the latest solid state magnetic sensor technologies to proprietary circuits capable of providing EMI, ESD, EMC and Conducted Immunity resistance tough enough to exceed automotive standards.
- To simulate the wide range of environments that our products experience in the field, Cherry's testing facilities provide concept evaluation, design and product validation, and continuous conformance testing to international standards.
- In-house high-density circuit board assembly assures the quality of our electronics.
- TS-16949 certified factories on multiple continents provide you with advantages in speed, cost and flexibility.

**Put Cherry's broad capabilities to work for you in your most demanding applications.**

For more information on Cherry products contact ZF Electronics today.

**Phone: +49 9643 180**

**Web: [www.cherry.de](http://www.cherry.de)**



# TABLE OF CONTENTS







## **Magnetic Position Sensors**

### **MP Series**

MP1014 Low-Profile	6
MP1007 Threaded Housing	7
MP1013 Snap-Fit	8
MP1021 Flange-Mount	9
MP2007 Threaded Housing	10
MP2017 Cylindrical Plastic Housing	11
MP2018 Mini Flange-Mount	12
MP2019 Flange-Mount	13

## **Vane Sensors**

### **VN Series**

VN1015 Digital Vane Sensor	14
----------------------------	----

## **Geartooth Speed Sensors**

### **GS Series**

GS1001 – 1002 Threaded Housing	15
GS1005 – 1007 Threaded Housing	16
GS1012 Flange Mount	17

## **Geartooth Speed and Direction Sensors**

### **SD Series**

SD1012 Speed and Direction	18
----------------------------	----

## **Angular Position Sensors**

### **AN Series**

AN1 Intrinsically Linear Angular Position Sensors	19
AN8 Thin Angular Position Sensors	20

## **Magnetic Actuators and Mating Connectors**

### **AS Series**

AS101001 & AS500106 Actuator Magnets	21
--------------------------------------	----

## **Custom Capability Sensors**

22

## **Compendium**

24

## MP1014 Series



Digital Hall-effect position sensor in low-profile flange-mount housing.

### Features

- Capable of millions of operations
- Reverse Battery Protection to -24VDC
- MP101401 south pole activated unipolar switching
- RoHS Compliant
- Latching versions available on special order basis

### Applications

- Door position sensing
- Flow sensing
- Pedal switch

### Specifications

Part Number	Operating Voltage Range (VDC)	Supply Current (mA max.)	Output	Output Saturation Voltage (mV max.)	Output Current (mA max.)	Operating Temp Range (°C)	Function	Operate Point Gauss (max.)	Release Point Gauss (min.)
MP101401	4.5 – 24	5.2	3-wire sink	400	20	-40 to 85	Unipolar Switch	185 (south)	60 (south)

Notes: These sensors require the use of an external pull-up resistor, the value of which is dependent on the supply voltage. See page 27 for recommendations.

Pull-up resistor should be connected between output (Green) and Vcc (Red).

Unipolar switch output turns low in presence of magnetic south pole. Bipolar latch output latches high in presence of magnetic south poles and latches low in presence of magnetic north pole.

### Dimensions inches (mm)

All tolerances  $\pm 0.005$  (0.13) unless otherwise noted.

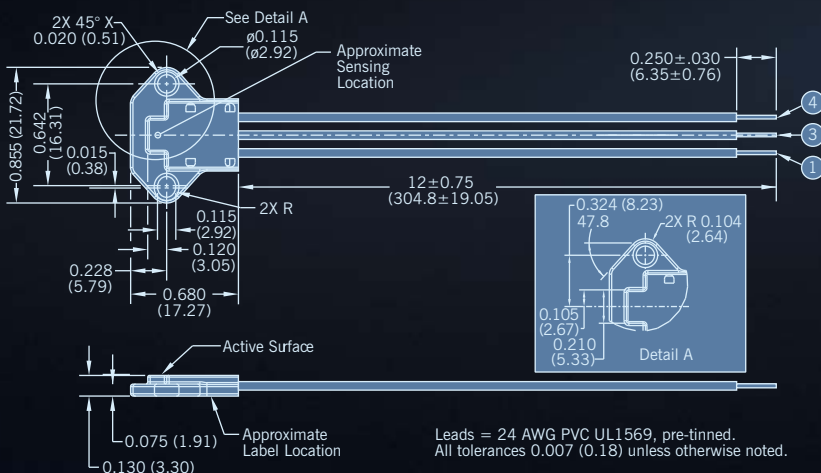

Leads = 24 AWG PVC UL1569, pre-tinned.  
All tolerances 0.007 (0.18) unless otherwise noted.

### Open Collector Sinking Block Diagram

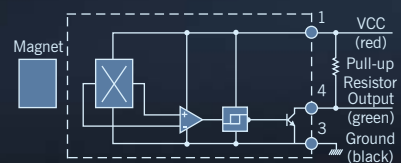

## MP1007 Series



Solid state, magnetic position sensors in adjustable, threaded housing.

### Features

- Excellent output stability over operating temperature range
- Regulated power supply not required
- Reverse battery protection to -24VDC
- Wire: 20 AWG, tin plated, polyolefin insulation
- Anodized aluminum housing
- South pole activated
- RoHS Compliant
- Open Collector (NPN) output can be used with bipolar or cmos logic circuits with suitable pull up resistor
  - Output switches low (off) when the magnetic field at the sensor exceeds the operate point threshold
  - Output switches high (on) when the magnetic field is reduced to below the release point threshold

### Applications

- Limit switch
- Home security
- Door position

### Specifications

Part Number	Operating Voltage Range (VDC)	Supply Current (mA max.)	Output	Output Saturation Voltage (mV max.)	Output Current (mA max.)	Operating Temp Range (°C)	Storage Temp Range (°C)	Operate Point Gauss (max.)	Release Point Gauss (min.)	Housing Color	Wires
MP100701	4.75 – 24	16	3-wire sink	700	25	-40 to 105	-40 to 125	300	60	Black	20 AWG x 1 m BBB

Notes: These sensors require the use of an external pull-up resistor, the value of which is dependent on the supply voltage. See page 27 for recommendations. Pull-up resistor should be connected between output (Black) and Vcc (Brown).

### Dimensions inches (mm)

All tolerances  $\pm 0.005$  (0.13) unless otherwise noted.

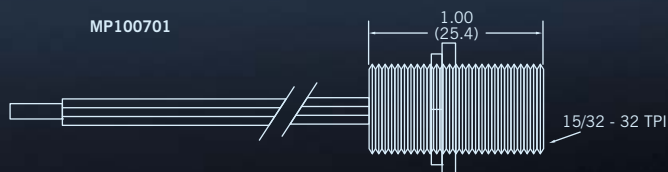

### Open Collector Sinking Block Diagram

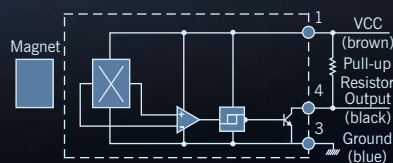

## MP1013 Series



Hall-effect position sensor with convenient snap-fit mounting.

### Features

- Solid state reliability
- Excellent output stability over operating temperature range
- Open Collector (NPN) output can be used with bipolar switch or cmos logic circuits with suitable pull up resistor
- MP101301 – unipolar switch
  - Output switches low (off) when the magnetic field at the sensor exceeds the operate point threshold.
  - Output switches high (on) when the magnetic field is reduced to below the release point threshold
- RoHS Compliant
- Latching version available on special order basis

### Applications

- Speed sensing
- Door interlock sensing
- Water flow sensing

### Specifications

Part Number	Operating Voltage Range (VDC)	Supply Current (mA max.)	Output	Output Saturation Voltage (mV max.)	Output Current (mA max.)	Operating Temp Range (°C)	Storage Temp Range (°C)	Operate Point Gauss (max.)	Release Point Gauss (min.)	Leads	Reverse Battery Protection
MP101301	4.75 – 24	9	3-wire sink	400	25	-40 to 85	-40 to 105	300	60	24 AWG x150mm	-24VDC

Notes: These sensors require the use of an external pull-up resistor, the value of which is dependent on the supply voltage. See page 27 for recommendations. Pull-up resistor should be connected between output (Green) and Vcc (Red).

### Dimensions inches (mm)

All tolerances  $\pm 0.005$  (0.13) unless otherwise noted.

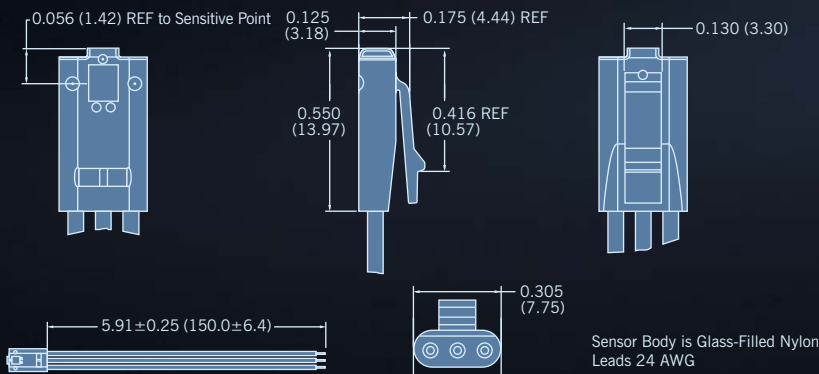

### Open Collector Sinking Block Diagram

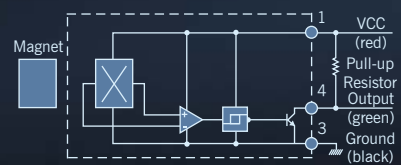

### Sensor Pocket

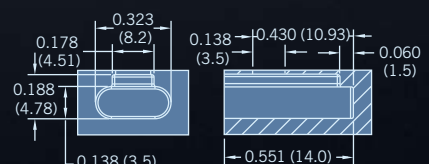



## MP1021 Series

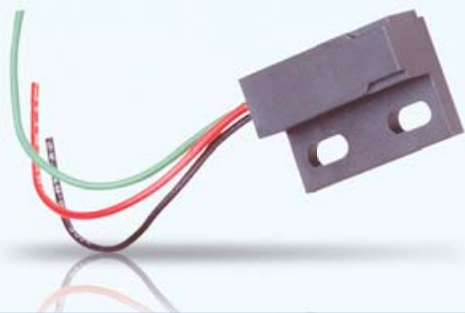

Digital Hall-effect position sensor in plastic flange-mount housing.

### Features

- Three sensing orientations available in convenient flange mount housing
- Excellent output stability over operating temperature range
- Compatible with unregulated power supply
- Reverse battery protection to -24VDC
- Open Collector (NPN) output can be used with bipolar switch or CMOS logic circuits with suitable pull up resistor
- MP102103 – north pole activated unipolar switch
  - Output switches low (off) when the magnetic field at the sensor exceeds the operate point threshold.
  - Output switches high (on) when the magnetic field is reduced to below the release point threshold
- RoHS Compliant

### Applications

- Interrupt switch
- Limit switch
- Door position

### Specifications

Part Number	Operating Voltage Range (VDC)	Supply Current (mA max.)	Output	Output Saturation Voltage (mV max.)	Output Current (mA max.)	Operating Temp Range (°C)	Function	Operate Point Gauss (max.)	Release Point Gauss (min.)	Sensing Location
MP102103	4.5 – 24	12	3-wire sink	500	25	-40 to 85	Switch	400 (north)	195 (north)	C

Notes: These sensors require the use of an external pull-up resistor, the value of which is dependent on the supply voltage. See page 27 for recommendations. Pull-up resistor should be connected between output (Green) and Vcc (Red).

### Dimensions inches (mm)

All tolerances  $\pm 0.005$  (0.13) unless otherwise noted.

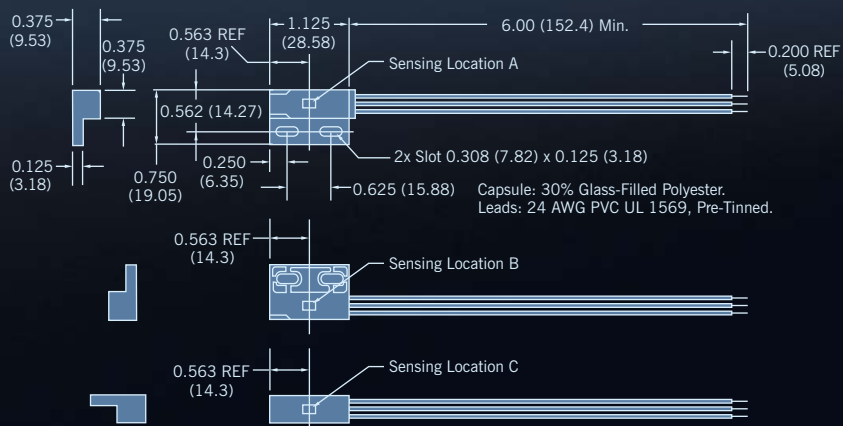

### Open Collector Sinking Block Diagram

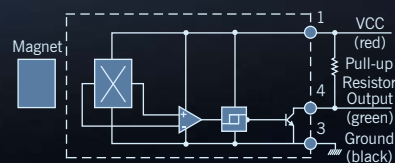

## MP2007 Series



Reed-based magnetic position sensor in aluminum threaded housing.

### Features

- Zero power consumption
- Suitable for DC and AC circuits
- Contacts hermetically sealed for long life
- RoHS Compliant

### Specifications

Part Number	Contact Form	Power Rating (W max.)	Switching Voltage (AC/DC max.)	Breakdown Voltage (VDC min.)	Switching Current (Amps max.)	Contact Resistance (Ohms max.)	Operating Temp Range (°C)	Operate Time (msec typical)
MP200701	SPST-NO Form A	10	AC 100 DC 100	200	0.5	0.100	-40 to 105	0.3
MP200702	SPST-NC Form B	3	AC 30 DC 30	200	0.2	0.100	-40 to 105	1.0
MP200703	SPDT-CO Form C	3	AC 30 DC 30	200	0.2	0.100	-40 to 105	1.0

### Dimensions inches (mm)

All tolerances  $\pm 0.005$  (0.13) unless otherwise noted.

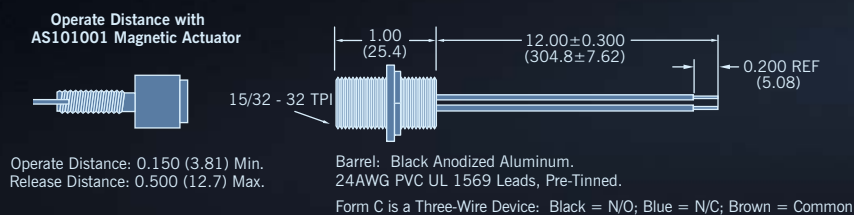



## MP2017 Series

Reed-based magnetic sensor encapsulated in smooth plastic barrel.

### Features

- Hermetically sealed contacts for long life
- Zero power consumption
- Available in a variety of standard contact configurations
- Resistant to moisture and dirt
- A standard magnetic actuator is available in the same housing (Cherry part number AS201701)
- RoHS Compliant

### Specifications

Part Number	Contact Form	Power Rating (W max.)	Switching Voltage (AC/DC max.)	Breakdown Voltage (VDC min.)	Switching Current (Amps max.)	Contact Resistance (Ohms max.)	Operating Temp Range (°C)	Operate Time (msec typical)
MP201701	SPST-NO Form A	10	AC 100 DC 100	200	0.5	0.100	-40 to 105	0.3
MP201702	SPST-NC Form B	3	AC 30 DC 30	200	0.2	0.100	-40 to 105	1.0
MP201703	SPDT-CO Form C	3	AC 30 DC 30	200	0.2	0.100	-40 to 105	1.0

### Dimensions inches (mm)

All tolerances  $\pm 0.005$  (0.13) unless otherwise noted.

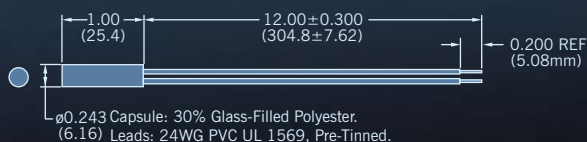

Form C is a Three-Wire Device: Black = N/O; Blue = N/C; Brown = Common

### Operate Distance with AS201701 Magnetic Actuator

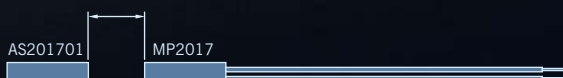

Operate Distance: 0.150 (3.81) Min.  
Release Distance: 0.500 (12.7) Max.





## MP2018 Series

Reed-based magnetic position sensor in plastic flange-mount package.

### Features

- Contacts hermetically sealed for long life
- Zero power consumption
- Resistant to moisture and dirt
- A standard magnetic actuator is available in the same housing (Cherry part number AS201801)
- RoHS Compliant

### Specifications

Part Number	Contact Form	Power Rating (W max.)	Switching Voltage (AC/DC max.)	Breakdown Voltage (VDC min.)	Switching Current (Amps max.)	Contact Resistance (Ohms max.)	Operating Temp Range (°C)	Operate Time (msec typical)
MP201801	SPST-NO Form A	10	AC 100 DC 100	200	0.5	0.100	-40 to 105	0.3
MP201802	SPST-NC Form B	3	AC 30 DC 30	200	0.2	0.100	-40 to 105	1.0

### Dimensions inches (mm)

All tolerances  $\pm 0.005$  (0.13) unless otherwise noted.

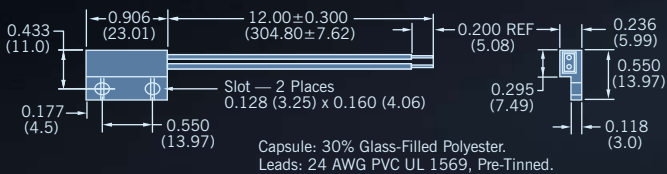

#### Operate Distance with AS201801 Magnetic Actuator

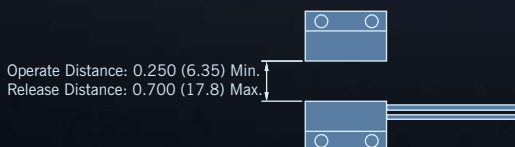

## MP2019 Series



Reed-based magnetic position sensor in plastic flange-mount package.

### Features

- Immune to hostile environments
- Contacts hermetically sealed for long life
- Suitable for DC and AC circuits
- Zero power consumption
- A standard magnetic actuator is available in the same housing (Cherry part number AS201901)
- RoHS Compliant

### Specifications

Part Number	Contact Form	Power Rating (W max.)	Switching Voltage (AC/DC max.)	Breakdown Voltage (VDC min.)	Switching Current (Amps max.)	Contact Resistance (Ohms max.)	Operating Temp Range (°C)	Operate Time (msec typical)
MP201901	SPST-NO Form A	10	AC 100 DC 100	200	0.5	0.100	-40 to 105	0.3
MP201902	SPST-NC Form B	3	AC 30 DC 30	200	0.2	0.100	-40 to 105	1.0
MP201903	SPDT-CO Form C	3	AC 30 DC 30	200	0.2	0.100	-40 to 105	1.0

### Dimensions inches (mm)

All tolerances  $\pm 0.005$  (0.13) unless otherwise noted.

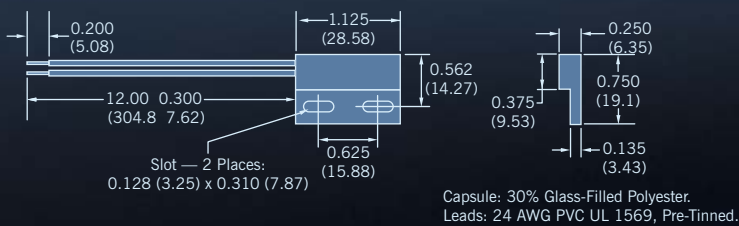

Operate Distance with AS201901 Magnetic Actuator

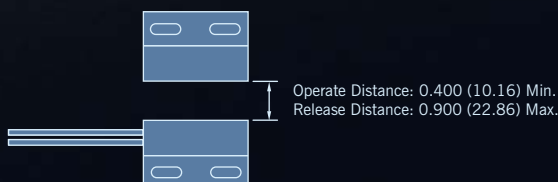

## VN1015 Series



Magnetically activated digital vane sensor in a rugged, overmolded plastic housing with three pins or 3-wire flying leads.

### Features

- Immune to moisture and dust
- Reliable and repeatable
- No mechanical contacts to wear out
- Operates from 4.5 to 24VDC
- Reverse battery protection to -24VDC
- RoHS Compliant
- Open collector (sinking or NPN) output can be used with bipolar or cmos logic circuits with suitable pull up resistor
- Sensor body material: glass-filled polyester
- Recommended vane parameters: low carbon material at least 0.040" thick, should penetrate to a depth < 0.120" from bottom of sensor slot.
- 25 khz maximum operating speed

### Specifications

Part Number	Operating Voltage Range (VDC)	Supply Current (mA max.)	Output	Output Saturation Voltage (mV max.)	Output Current (mA max.)	Operating Temp Range (°C)	Storage Temp Range (°C)	Termination
VN101501	4.5 – 24	6	3-pin sink	400	25	-40 to 85	-40 to 85	pins
VN101503	4.5 – 24	6	3-wire sink	400	25	-40 to 85	-40 to 85	24 AWG x 150mm leads

Notes: These sensors require the use of an external pull-up resistor, the value of which is dependent on the supply voltage. See page 27 for recommendations. Pull-up resistor should be connected between output (Green) and Vcc (Red).

### Dimensions inches (mm)

All tolerances ±0.005 (0.13) unless otherwise noted.

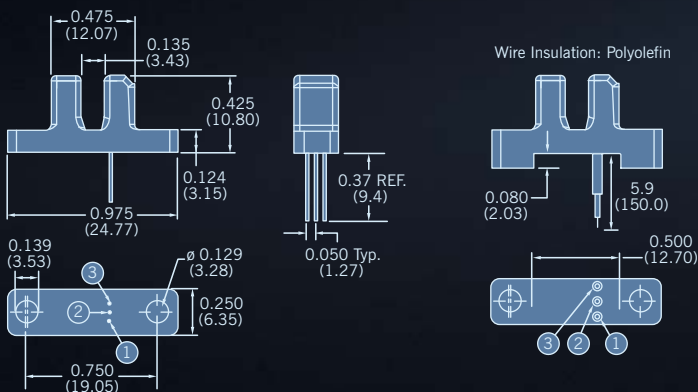

### Open Collector Sinking Block Diagram

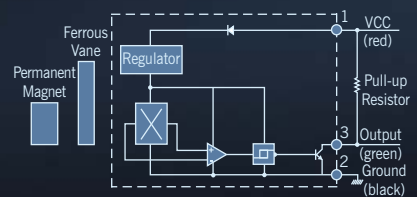





## GS1001-GS1002 Series

Circuit-protected, Hall-effect geartooth speed sensor with adjustable stainless steel housing.

### Features

- Senses motion of ferrous geartooth targets
- Near zero speed sensing capability
- Immune to rotational alignment
- 10 bit dynamic threshold detection offers
  - Automatically adjusting magnetic range
  - Self compensating to target geometry
  - Immune to target run out
- Compatible with unregulated power supply
- Reverse battery protected to -24VDC
- Internal circuit protection to IEC529 1,000
  - EMI resistant to 10V/m, 30MHz to 1GHz
  - ESD resistant to 4kV (contact discharge)
  - Fast transient resistant to 2kV
  - Conducted immunity resistant to 10VRMS@150kHz to 80MHz
  - EMC compatible 30A/m@50Hz
- Cable version: 22 AWG, tin plated with drain wire and polyolefin insulation
- Connector version: M12 integral connector meets IEC 60947-5-2 for low voltage devices
- Stainless steel housing

### Applications

- CNC machine tools
- Transmission speed
- Industrial feedback control

### Specifications

Part Number	Operating Voltage Range (VDC)	Supply Current (mA max.)	Output	Output Saturation Voltage (mV max.)	Output Current (mA max.)	Operating Temp Range (°C)	Storage Temp Range (°C)	Thread	Barrel Length	Cable	Connector
GS100101	4.5 – 24	6	sink	700	25	-40 to 105	-40 to 105	M12-1	65mm	_____	12 mm circular
GS100102	4.5 – 24	6	sink	700	25	-40 to 125	-40 to 125	M12-1	65mm	22 AWG x1m BBB	_____

Notes: These sensors require the use of an external pull-up resistor, the value of which is dependent on the supply voltage. See page 27 for recommendations. Pull-up resistor should be connected between output and Vcc.

### Dimensions inches (mm)

All tolerances ±0.005 (0.13) unless otherwise noted.

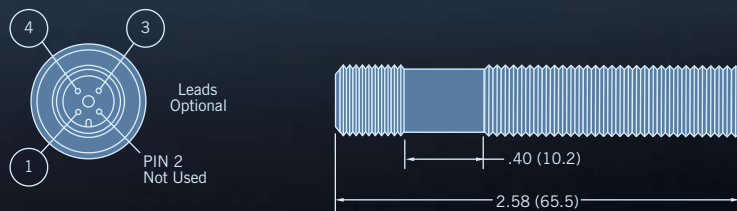

### Open Collector Sinking Block Diagram

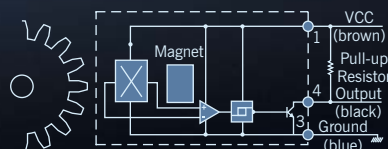

# GEARTOOTH SPEED SENSOR

## GS1005-GS1007 Series



Hall-effect geartooth speed sensor with adjustable aluminum housing.

### Features

- Senses motion of ferrous geartooth targets
- Near zero speed sensing capability
- Immune to rotational alignment
- 10 bit dynamic threshold detection offers
  - Automatically adjusting magnetic range
  - Self compensating to target geometry
  - Immune to target run out
- Compatible with unregulated power supply
- Reverse battery protected to -24VDC
- Discrete wire version: 20 AWG, tin plated, polyolefin insulation
- Connector version: M12 integral connector meets IEC 60947-5-2 for low voltage devices
- Hard coat anodized aluminum housing

### Applications

- Exercise equipment
- Food processing equipment
- Speedometer

### Specifications

Part Number	Operating Voltage Range (VDC)	Supply Current (mA max.)	Output	Output Saturation Voltage (mV max.)	Output Current (mA max.)	Operating Temp Range (°C)	Storage Temp Range (°C)	Thread	Barrel Length	Leads	Connector
GS100502	4.5 – 24	6	sink	400	25	-40 to 125	-40 to 125	M12-1	65mm	20 AWG x1m BBB	_____
GS100701	4.5 – 24	6	sink	400	25	-40 to 125	-40 to 125	15/32" – 32	1.00"	20 AWG x1m BBB	_____

Notes: These sensors require the use of an external pull-up resistor, the value of which is dependent on the supply voltage. See page 27 for recommendations. Pull-up resistor should be connected between output (Black) and Vcc (Brown).

### Dimensions inches (mm)

All tolerances ±0.005 (0.13) unless otherwise noted.

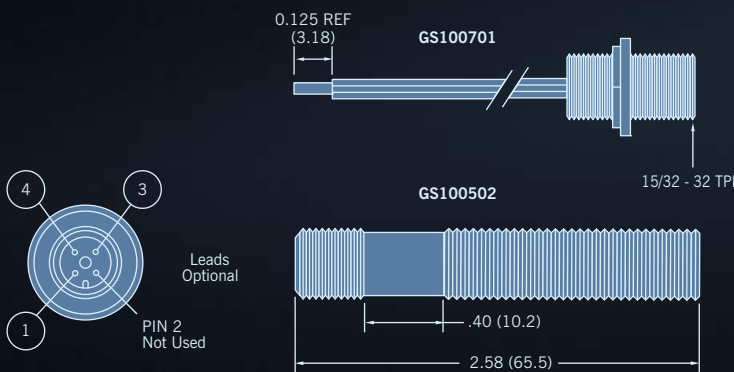

### Open Collector Sinking Block Diagram

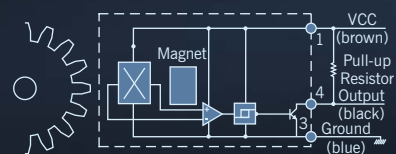



## GS1012 Series

Flange mount gear sensor rated to 150°C.

### Features

- Capable of operating up to 150°C
- Sealed design exceeds IEC60529 IP67 standard for immersion
- Resistant to fuels, solvents, and lubricants associated with engines, transmissions, brakes and chassis systems
- Easily customizable connector orientation
- ESD resistant to 15kV (contact discharge)
- Operates at arbitrarily low speeds
- Mating connector Delphi 12162280

### Applications

- Transmission speed
- Wheel speed
- Engine speed
- Anti-lock braking systems

### Specifications

Part Number	Operating Voltage Range (VDC)	Supply Current (mA max.)	Output	Output Saturation Voltage (mV max.)	Output Current (mA max.)	Operating Temp Range (°C)	Storage Temp Range (°C)	Leads	Connector
GS101205	5.0 – 30	6	sink	600	25	-40 to 150*	-55 to 150	_____	Delphi**

Notes: These sensors require the use of an external pull-up resistor, the value of which is dependent on the supply voltage. See page 27 for recommendations. Pull-up resistor should be connected between output and Vcc.

\* For continuous operation at 150°C, supply voltage should be limited to 5.5V max.

\*\* Delphi 12162280

### Open Collector Sinking Block Diagram

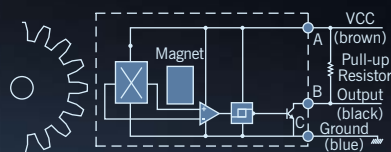

### Dimensions inches (mm)

All tolerances  $\pm 0.005$  (0.13) unless otherwise noted.

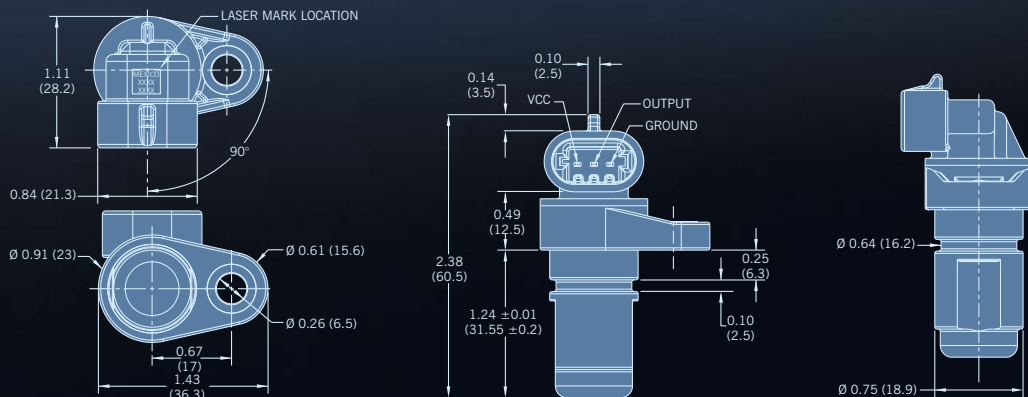



# GEARTOOTH SPEED AND DIRECTION SENSOR

## SD1012 Series



Hall-effect geartooth speed and direction sensor with adjustable aluminum or flange-mount plastic housing.

### Features

- Sense speed and direction of ferrous geartooth targets
- Plastic flange mount sensor rated to 125°C
- Near zero speed sensing capability
- Capable of 8000+ Hz target speed
- 10 bit dynamic threshold detection offers:
  - Automatically adjusting magnetic range
  - Self compensating to target geometry
  - Immune to target run out
- Compatible with unregulated power supply
- Reverse battery protected to -30VDC
- Internal circuit protection to IEC529 1,000
  - EMI resistant to 10V/m, 30MHz to 1 GHz
  - ESD resistant to 4 kV (Contact discharge)
  - Fast transient resistant to 2 kV
  - Conducted immunity resistant to 10VRMS@150kHz to 80 MHz
  - EMC compatible 30A/m @ 50Hz

- Meets IEC60529 IP67 for dust and water protection
  - Integral Connector version: 4-pin Delphi Metri Pack 150.2 No. 12162833. Mates with Terminal No. 12124075.
  - Discrete wire version: 20 AWG, PVC insulation, UL1007/1569

### Applications

- Wheel speed and direction
- Transmission speed and direction
- Hoist speed and direction

### Specifications

Part Number	Operating Voltage Range (VDC)	Supply Current (mA max.)	Output	Output Saturation Voltage (mV max.)	Output Current (mA max.)	Operating Temp Range (°C)	Storage Temp Range (°C)	Housing Material
SD101201	4.75 – 24	20	sink	1000	20	-40 to 125	-40 to 125	Plastic

Notes: SD101201 uses Delphi Metri-Pack 150.2 Series Part No. 12162833. Mating terminal: Delphi Part No. 12124075. A pull up resistor is required between power and each output. Resistor value is dependent upon input voltage. See page 27 for recommendations.

### Dimensions inches (mm)

All tolerances  $\pm 0.005$  (0.13) unless otherwise noted.

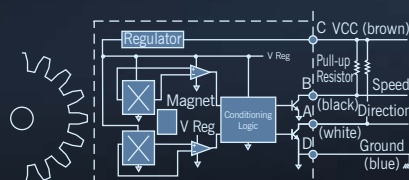
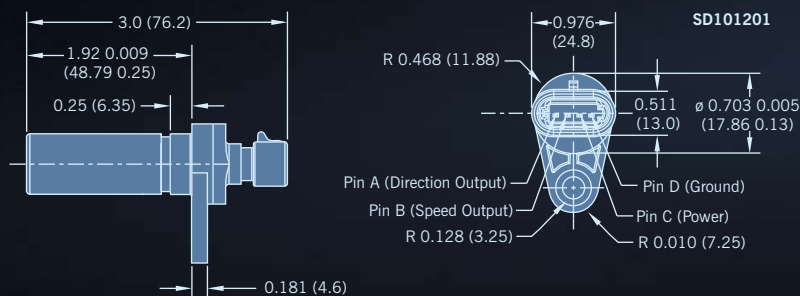



## AN1 Series

Intrinsically Linear Angular Position Sensor

### Features

- Patented non-contact angular position sensor
- Magnet/sensor orientation provides intrinsically linear output up to 85 degrees of electrical rotation (120 degrees mechanical rotation) without need for electrical compensation
- Provided with programmed output or end-user re-programmable to eliminate mechanical and process tolerances in your final assembly
- Adjustable rising or falling output slope with programmable offset, gain temperature compensation, and clamping voltage
- Return spring provides resistance to CCW motion
- Provided with EMI/ESD protection
- Fully encapsulated electronics to IEC 60529 IP67
- ILAPS® technology can be custom packaged to meet your exact requirements (minimum quantities apply)

### Applications

- Throttle and valve position sensing
- User interface controls (vehicles, gaming)
- Pedal position sensing
- Implement position sensing
- Gear Selection
- Joystick position

### Environmental Specifications

Vibration	10 G's peak, 20 Hz to 1,000 Hz
Shock	20G's, half sine pulse, 13ms duration
Operating Temperature	-40°C to +125°C
Storage Temperature	-40°C to +135°C

### Dimensions mm

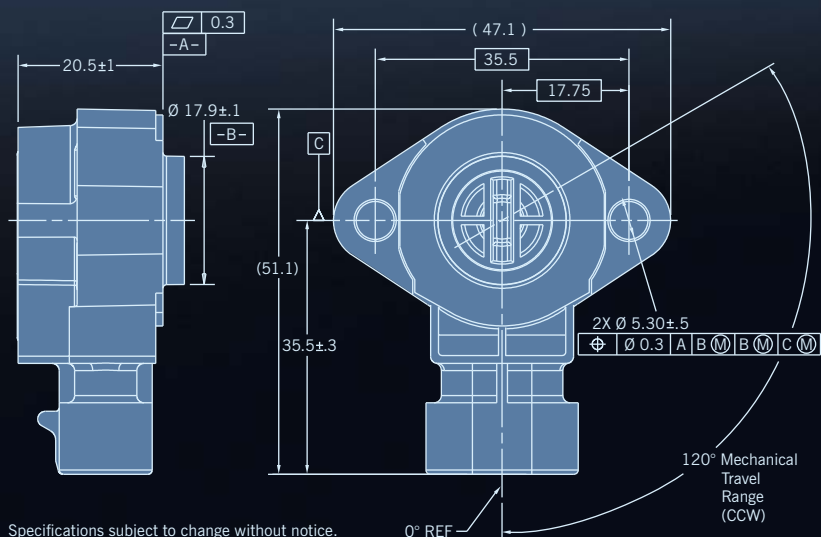

### Electrical Specifications

Effective Rotational Sensing Range	Maximum 85° electrical output
Input Voltage	5.0V ± 10%
Input Current	10 mA, max.@ 5VDC
Input Current, Output(s) Shorted to Ground	25 mA, max. per output
Max Overvoltage	16VDC
Sensor Output @ 5VDC (Ratiometric to Input Voltage)	0.5V to 4.5V Max, programmable within 5% to 95% of the nominal voltage with positive or negative slopes
Output Linearity @ 5VDC	± 2%
Resolution	Analog
Response Time	.23 mSEC
Bulk Current Injection	SAE J1113-4, 250 kHz to 500 MHz., 60 mA/m
Conduction and Coupling	SAE J1113-12; ± 200V
Electronic Discharge	SAE J1113-13; ± 15kV
Radiated Immunity	SAE J1113-21; 10 kHz to 18 GHz, 100 V/m
Immunity to Magnetic Fields	SAE J1113-22; 600 uT AC Field, 5 Hz to 2 kHz, .2 mT & 1 mT DC Field
Immunity to AC Fields	SAE J1113-26, 15,000 V/m
Radiated Emissions	SAE J1113-41; Class 4

### Mechanical Specifications

Mechanical Travel	120° CCW maximum rotational travel
Rotation Torque	0.12 N-m max with return spring
Mass	12 grams
Life	+ 10 million full cycles
Dither (2° Travel)	+ 80 million cycles
Mating Connection	Connector: Packard metri-pack 150 12162185 Terminal: 12124075

### AN101101 85° Sensor Output

(Typically Based on 5V Supply)

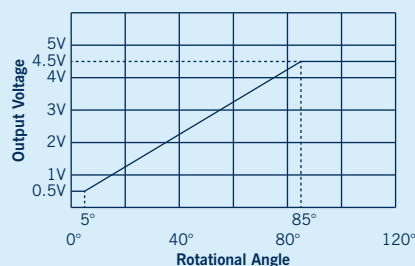

## AN8 Series



Programmable, non-contact magnetic position sensors capable of continuous rotation

### Features and Benefits

- Angular position with high tolerance for misalignment
- Provides non-contact angular position sensing and full 360° rotation
- 5VDC ratiometric device.
- Linear output over specific angular rotation ranges available on request
- Sealed design exceeds IEC 60529 IP67 standard for immersion
- Performs with AS500106 standard magnetic carrier
- Sensor can be programmed for use with custom magnets
- Custom programming option for rising or falling output slope with selectable offset, gain, clamp voltage
- PWM output option available for custom applications
- Provided with EMI/ESD protection to SAE J1113 standards
- No mechanical interface means no parts to wear out

### Description

The sensor is applied by rotating a magnetic actuator close to the face of the sensor. Output voltage varies with angular position of the magnet relative to the sensor.

Optimal performance is achieved with Cherry's AS500106 magnetic actuator. Sensor kits including this standard magnet are available

### Applications

- Throttle position sensor
- Replacement for smart bearings
- PRNDL switch for harsh environments
- Steer wheel position for drive by wire systems
- Pedal position sensor

### Mechanical Specifications

<b>Mechanical Travel</b>	0 to 360 degrees (no stops)
<b>Dither</b>	No mechanical contact
<b>Mating Connector</b>	Connector: Delphi Metri-pak 150.2 12162185 Terminal:12124075
<b>Maximum Air Gap</b>	5 mm
<b>Maximum Center-to-Center Offset</b>	2 mm diameter (magnet to sensor)

### Dimensions mm

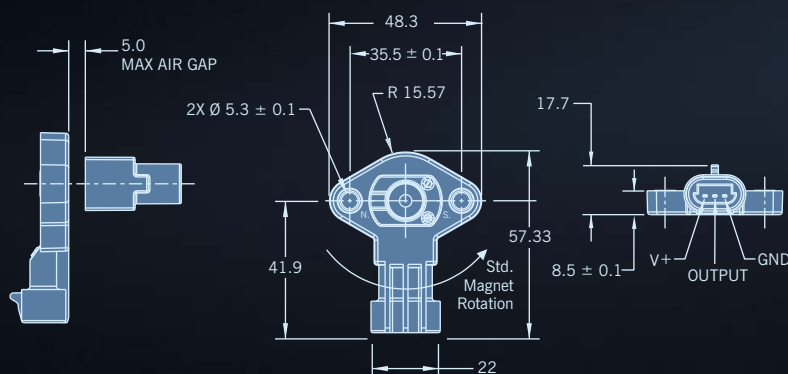



## Electrical Specifications

Effective rotational sensing range	0 to 360 degrees of rotation
Input Voltage	5.0VDC $\pm$ 10%
Max Overvoltage	14VDC reversed voltage -10VDC
Output Current Range	8 mA
Resolution	Analog
Conduction and Coupling	SAE J1113-12; $\pm$ Level 3
Electronic Discharge	SAE J1113-13; $\pm$ 15kV
Immunity to Magnetic Fields	SAE J1113-21
Conducted Transient Emissions	SAE J1113-42
Radiated Emissions	SAE J1113-41; Class 4
Output Linearity (with supplied magnet)	$\pm$ 2.5% Full Scale
Analog Output Slew Rate	200V.ms
Accuracy	$\pm$ 2%
Operating Temperature	-40 to 125°C

## Sensor Output Signal

### Rotation Angle

(Percent of Sensing Range: 45°; 90°; 180°; or 360°)

### Output Voltage

( $V_s = 5$  VDC.)

Output is ratiometric for  $V_s = 4.5$  to  $5.5$  VDC.)

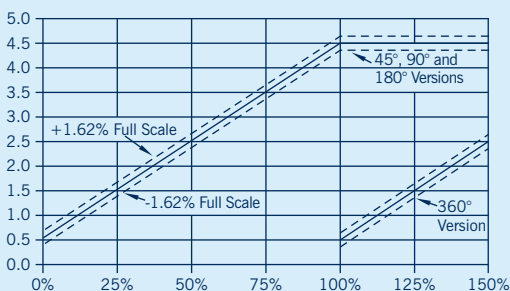

Sensor	Sensing Range	Sensor/Magnet Assembly Kit #
AN820001	180°	CU103601*
AN820002	360°	CU103602*
AN820003	45°	CU103603*

## Magnets

Actuator Magnet

### AS101001

Easy to install actuator magnet with threaded aluminum holder.

- South pole facing Alnico magnet

Also available in the same package:

- AS101002 with north pole facing Alnico magnet
- AS101003 with south pole facing samarium cobalt magnet

Magnet Carrier

### AS500106

- PPS Housing
- SmCo28 Magnet
- Recommended fastener: M4 Cap Screw
- Recommended torque: 3 Nm (26.5 in lbs.)

## Dimensions inches (mm)

All tolerances  $\pm 0.005$  (0.13) unless otherwise noted.

### AS101001

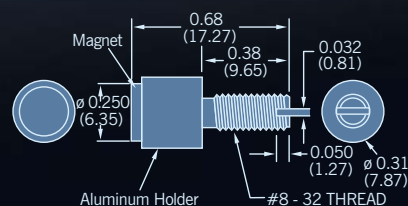

### AS500106

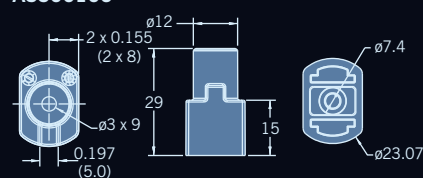

\*Includes AN8 sensor and AS500106 magnetic actuator

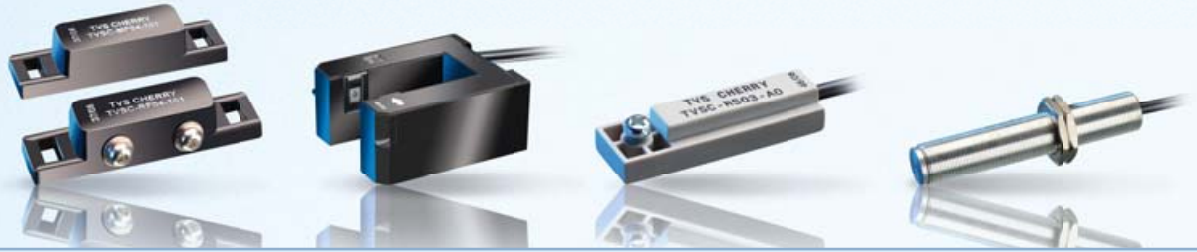

## Magnetic Reed Sensor

### Features

- Hermetically sealed contacts for long life
- Available in SPST-NO/NC & SPDT versions
- Choice of higher electrical rating, magnet, termination, different cable types & cable lengths
- Moisture and dirt resistant
- Magnet available with same housing
- Zero power consumption

### Application

- Door sensing

## Infrared Vane Sensor

### Features

- High-speed capability (> 2.5 m/sec.)
- EMI/EMC compliant
- Encapsulated to meet IP65
- Available in NPN open collector, Opto transistor output
- Wide range of input voltages
- Separate LED indication for power & output
- Choice of different termination & cable lengths
- Highly immune to environmental factors (dust, temperature)

### Application

- Floor Level Sensing in High Speed Elevators

## Door Information Sensor

### Feature

- Ferrite magnet (40 x 25 x 10mm) or ring magnet separately available
- Latch type

### Application

- Door sensing

## Cylindrical Proximity Sensor

### Features

- NO/NC type contacts available
- Customized wire length
- Available with ferrite magnet (40 x 25 x 10mm)

### Application

- Floor level sensing in elevators





## Level Sensor

### Features

- External mount
- Fast fitting
- Compact size
- Easily serviceable
- Customized wire length
- Operating temperature -10°C to +60°C

### Application

- Float and level sensing (water/oil)

## Bistable Latch Sensor

### Features

- Latch type
- Lifetime: 100,000 operations min.
- Zero power consumption

### Application

- Door sensing

## ATEX approved Sensor

### Features

- Hermetically sealed contacts
- Available in SPST NO/NC version
- Customized cable length and termination
- Resistance to moisture and dirt
- CE & ATEX approvals

### Application

- Fuel Dispensing pumps

## In General

### Airgap

The switching distance of a sensor to a magnet or any other target to be detected depends on several factors, including:

- Sensing characteristics of the sensor
- Magnet material
- Magnet dimensions
- Relative motion of the magnet with respect to the sensor
- Presence of nearby magnetic or ferrous materials

### ESD Sensitivity

- Cherry Reed sensors are not solid-state devices and thus immune to ESD
- Several of our solid-state series sensors, among them GS1001-1004, GS1012 and SD1012, are equipped with additional circuitry to enhance ESD immunity. They have been tested for ESD immunity in accordance with IEC publication 1000-4-2 using testing standard EN50082-2.

Other sensors, including MP1013, MP1021, GS1005-1009 and VN1015, should be treated as ESD sensitive and handled like other ESD-sensitive devices.

### Connection

Depending on the type and version, Cherry sensors are equipped either with a defined standard connector or with wires for individual connection.

### Housing

Cherry sensors are delivered in ready-for-assembly housings for the indicated protection class.

## Vane Sensors

These sensors are actuated by vanes passing by the airgap. The ferromagnetic vane thereby changes the magnetic field between the sensor and the magnet in the two arms of the fork.

### Vane Material

In general, all ferrous materials should have suitable vanes. We recommend iron or steel.

### Vane Dimensions

We recommend a minimum vane material thickness of at least 1 millimeter and minimum width of at least 6.35 millimeters. The vane should penetrate a depth of less than 3 millimeters from the bottom of the sensor slot.

## Vane Dimensions mm

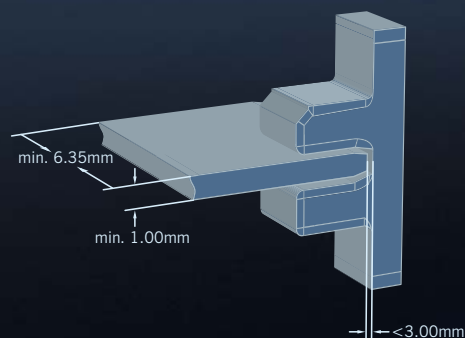

## Magnetic Proximity Sensors

Hall and Reed sensors, two types of magnetic proximity sensors, are most commonly used for long-life position and presence sensing. Cherry offers a wide range of Hall and Reed sensors.

### Different Designs

Hall and Reed sensors differ greatly in the way they function. A Hall sensor is a solid-state device whose output changes when exposed to a magnetic field. A Reed sensor, on the other hand, is electrically switched with tiny contacts that open or close in the absence or presence of a magnetic field.

### Different Applications

Both types of sensors can be used for many similar applications, but there are also cases where one is clearly better than the other.

### Unlimited Lifespan

Thanks to its almost unlimited lifespan, Hall sensors are ideal for gear-tooth speed and rotary position sensing. Reed sensors cannot match the virtually infinite life of a Hall sensor.

### Energy Efficiency

Reed sensors have zero power consumption in stand-by mode and are, thus, very energy efficient. In addition, they are immune to ESD. Reed sensors are also frequently used for applications with supply voltages outside the typical 5VDC to 24VDC range of Hall sensors. They can effectively switch 110VACac at low current.

### Reed Sensors

Cherry offers Reed sensors in different contact configurations:

- Normally open (Form A)** This sensor is normally open in the absence of a magnetic field, and closed near a magnetic field
- Normally closed (Form B)** This sensor is closed in the absence of a magnetic field, and open near a magnetic field
- Changeover (Form C)** This sensor has three leads representing the normally open, normally closed and common contacts. It is a "changeover" device because the common contact changes from the normally closed to the normally open position when a magnetic field is nearby

### Magnetic Poles

Most solid-state sensors of our standard product line are south-pole sensitive. Exceptions: the bipolar latching sensors MP101303 and MP101304, which are latched with a south pole and unlatched with a north pole. The MP1021 series includes both north pole-sensitive devices and latching devices. All of our Reed sensors (MP2007 through MP2019) are omnipolar

### Airgap (Distance Sensor – Magnet)

The field strength at various points around a permanent magnet is dependent on several factors, including the shape, size and material of the magnet. Our bipolar latching sensors MP101303 and MP102104 have relatively low gauss thresholds, allowing for somewhat wider airgaps.

### Switching Hysteresis

The switching hysteresis is determined by the difference between the sensing face and magnet detection distance as well as the sensing face and magnet release distance.

## Sensor Operation

A Reed Sensor is an omnipolar, magnetically activated switch. It can be approached by a magnet from any angle and with either pole. Several possible operating methods are shown below.

### Perpendicular magnet travel

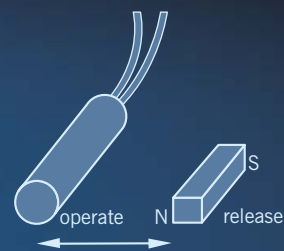

This method maximizes air gap

### Parallel magnet travel

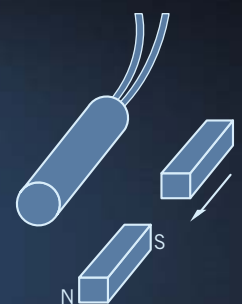

Up to three operations possible with one magnet

### Nose-to-nose activation

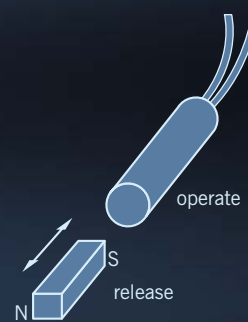

Both ends of the magnet work equally well

### Rotational magnet travel

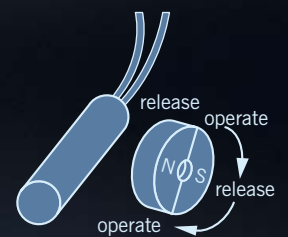

Multi-pole ring magnets can be used to achieve a larger number of operations per rotation

## Gear Tooth Sensors

The category gear tooth sensors comprises speed sensors as well as combined speed and direction sensors.

### Speed and Direction Measurement

The Cherry SD series speed & direction sensors provide both speed and direction output. The SD series sensor incorporates two Hall effect ICs that are slightly offset from one other. Internal conditioning logic analyzes the phase difference between the two sensors to determine the direction of the target rotation.

The standard SD series sensor has two separate digital outputs. It uses an open collector (sinking) output. The speed output switches from high (Vcc) to low (close to zero) when it detects a transition from "no-tooth" to "tooth present." The separate direction output is high when gear rotation is clockwise, and low when gear rotation is counter-clockwise.

### Operating a Speed Sensor

Although commonly called a gear tooth sensor, a solid-state speed sensor can detect the motion of various ferrous objects with some type of discontinuous surface.

Examples of appropriate targets include:

- Sprockets
- Bolt heads
- Roller chains
- Cavities in smooth surfaces

For best results, we recommend targets made from low carbon cold-rolled steel. Other factors that influence sensor performance include gear tooth height and width, space between teeth, shape of the teeth and target thickness. As a general guideline, consider a target with the following minimum parameters:

Tooth height	Tooth width	Distance between teeth	Target thickness
5 mm (.200")	2.5 mm (.100")	10 mm (.400")	6.25 mm (.250")

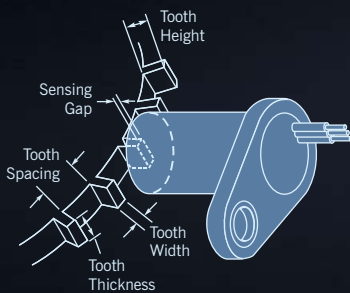

### Airgap (Distance Sensor – Target)

The required distance between sensor and target depends on the installation situation. In general, smaller gear teeth require smaller airgaps while larger gear teeth allow for larger airgaps. Consider starting with an airgap of 1 to 2 millimeters (.040" to .080").

### Orientation

Cherry GS series gear tooth sensors are not orientation-sensitive. Cherry SD series speed & direction sensors do have an orientation requirement, and the appropriate orientation is noted on the part itself.

### Operating Life

As a solid-state device with no moving parts, a Cherry gear tooth sensor's operational life is virtually unlimited.

### Frequency

The measuring range is somewhat dependent on the target and particular sensor, but maximum frequency is generally >10 kHz. Care must be taken in calculating the frequency depending on the target geometry. With asymmetrical targets, for example, ones with narrow tooth widths compared to tooth gaps, the time between the leading and trailing edge of the tooth is generally the governing factor. Our sensors have maximum response times from approximately 10 μS (MP series) to 50 μS (GS series) due to internal Hall cell processing schemes. If your response time is close to these numbers, unexpected results, such as lost counts, can occur.

As opposed to a variable reluctance sensor, a Cherry GS series gear tooth sensor has an output amplitude that is independent of input frequency. It does not require a minimum speed. However, it does require some initial movement of the target in order to locate the tooth edge. We therefore call it a "near-zero-speed" sensor, whereas others refer to similar products as "zero-speed" sensors.

### Position Sensor with Ring Magnet

Cherry's solid-state magnetic position sensors also make excellent speed sensors when coupled with a rotating ring magnet. Advantages of this approach include:

- lower sensor cost
- larger airgaps and
- absolute zero-speed sensing.

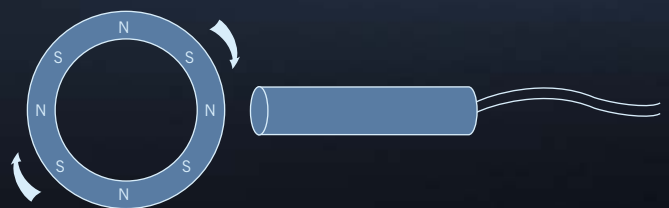



## Current Sink Interfacing

### 3-Wire Sinking Interface

Sinking outputs are often used in negative logic applications, where a low signal is required for an active state. There, sinking outputs normally have current flowing into the device output lead when the device is active. Also called “open collector outputs,” sinking outputs are compatible with any logic family since a wide voltage range may be used for Vcc. Furthermore, the voltage level used to power the Hall effect assembly may differ from the pull-up resistor to which it is attached. The external pull-up resistor connected between the output and Vcc is required for proper operation. With the resistor connected as shown, the output will be “pulled up” to Vcc when off and (approximately) to ground when on.

Recommended pull-up resistor values are as follows:

Volts dc	5	9	12	15	24
Ohms	1 k	1.8 k	2.4 k	3 k	3 k

Sensor Series	Connector Type	Connection Grid					
		Vcc	Output	Ground	Direction	Speed	
MP	12mm circular	1	4	3	N/A	N/A	
	Wire Lead	Brown	Black	Blue	N/A	N/A	
	Wire Lead	Red	Green	Black	N/A	N/A	
GS	12mm circular	1	4	3	N/A	N/A	
	Wire Lead	Brown	Black	Blue	N/A	N/A	
	Delphi	A	B	C	N/A	N/A	
VN	Pin	1	3	2	N/A	N/A	
	Wire Lead	Red	Green	Black	N/A	N/A	
SD	Delphi	C	_____	D	A	B	

## Dimensions inches (mm)

All tolerances ±0.005 (0.13) unless otherwise noted.

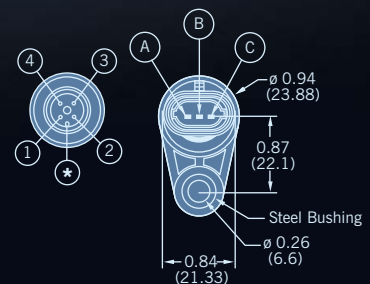
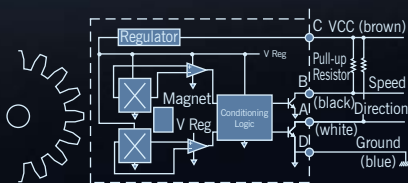



**ZF Electronics GmbH**

Cherrystraße  
91275 Auerbach  
Germany  
Phone: +49 96 43 18-0  
Fax: +49 96 43 18 17 20  
switches@cherry.de  
www.cherry.de

**ZF Electronics Corporation**

11200 88th Avenue  
Pleasant Prairie, Wisconsin  
USA 53158-0913  
Phone: +1 262 942 6500  
Fax: +1 262 942 6566  
www.cherrycorp.com

**ZF Electronics Asia Limited**

13 / F, Blk. A, North Point Ind. Bldg.  
499 King's Road, North Point  
Hong Kong  
Phone: +852 2565 6678  
Fax: +852 2565 6827

**ZF Electronics TVS (India) Private Limited**

Madurai - Melur Road,  
Vellaripatti, Madurai - 625 122  
India  
Phone: +91 452 2420218  
Fax: +91 452 2420382

Errors, technical changes, and delivery possibilities subject to change. Technical data is based on the specifications of the products only. Features are not guaranteed herewith. Binding data can be found only in drawings in conjunction with product specifications.

801276; 45576015; D; 04/2010; 2; MIN  
© 2010 ZF Electronics GmbH

