

Application Note

AN2531/D  
Rev. 0, 5/2003

Standard Space Vector  
Modulation with Dead-Time  
Correction – XOR version  
TPU Function Set  
(svmStdDtXor)



By Milan Brejl, Ph.D.

Functional Overview

The Standard Space Vector Modulation with Dead-Time Correction – XOR version (svmStdDtXor) is a version of the Standard Space Vector Modulation with Dead-Time Correction (svmStdDt) function that uses two TPU channels to generate one PWM output channel. The TPU channel outputs are connected to an XOR gate whose output is the required PWM signal. See **Figure 1**. An advantage of this solution is the full range 0% to 100% of PWM duty-cycle ratios. There is no MPW (minimum pulse width) parameter to limit the edge duty-cycle ratios in this version, unlike in the svmStdDt. A disadvantage is that the number of assigned TPU channels is doubled.

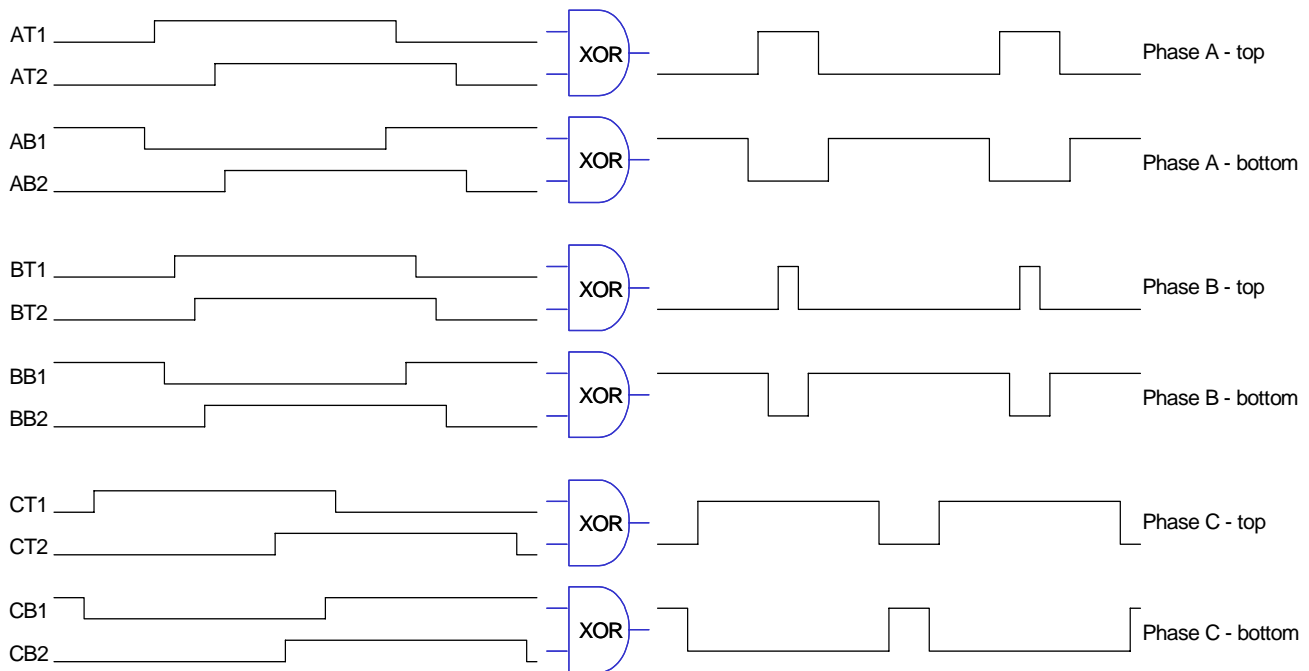
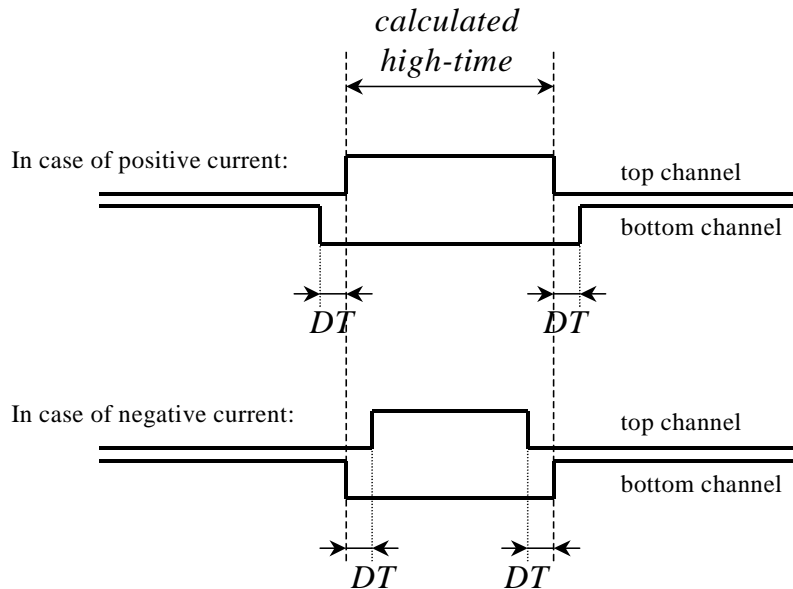

Figure 1. Functionality of XOR version – illustration

The dead-time correction technique requires knowledge of the instantaneous direction of phase currents. In the case of positive phase current the top channel high-time is equal to the calculated high-time and the bottom channel has to control the dead-time. In case of negative phase current the bottom channel low-time is equal to the calculated high-time and the top channel has to control the dead-time. See [Figure 2](#).



**Figure 2. Dead-Time Correction Technique**

The function set consists of 5 TPU functions:

- Standard Space Vector Modulation with Dead-Time Correction – XOR version – R channels (svmStdDtXor\_R)
- Standard Space Vector Modulation with Dead-Time Correction – XOR version – T channels (svmStdDtXor\_T)
- Synchronization Signal for Standard Space Vector Modulation with Dead-Time Correction – XOR version (svmStdDtXor\_sync)
- Resolver Reference Signal for Standard Space Vector Modulation with Dead-Time Correction – XOR version (svmStdDtXor\_res)
- Fault Input for Standard Space Vector Modulation with Dead-Time Correction – XOR version (svmStdDtXor\_fault)

The svmStdDtXor\_R and svmStdDtXor\_T TPU functions work together to generate 6 pairs of XOR gate inputs. The XOR gate outputs then produce a 6-channel 3-phase center-aligned PWM signal with dead-time between the top and bottom channels. The Synchronization Signal for the svmStdDtXor

function can be used to generate one or more adjustable signals for a wide range of uses, that are synchronized to the PWM, and track changes in the PWM period. The Resolver Reference Signal for the svmStdDtXor function can be used to generate one or more 50% duty-cycle adjustable signals that are also synchronized to the PWM. The Fault Input for the svmStdDtXor function is a TPU input function that sets all XOR gate outputs low when the input signal goes low.

---

## Function Set Configuration

None of the TPU functions in the Standard Space Vector Modulation with Dead-Time Correction – XOR version TPU function set can be used separately. The svmStdDtXor\_R and svmStdDtXor\_T functions have to be used together. The svmStdDtXor\_R runs on pins AB1, BB1, CB1 – see [Figure 1](#). The svmStdDtXor\_T runs on the other pins. One or more channels running Synchronization Signal for svmStdDtXor as well as Resolver Reference Signals for svmStdDtXor functions can be added to the svmStdDtXor\_R and svmStdDtXor\_T functions. They can run with different settings on each channel. The function Fault Input for svmStdDtXor can also be added to the svmStdDtXor\_R and svmStdDtXor\_T functions. It is recommended to use it on channel 15, and to set the hardware option that disables all TPU output pins when the channel 15 input signal is low (DTPU bit = 1). This ensures that the hardware reacts quickly to a pin fault state. Note that it is not only the PWM channels, but all TPU output channels, including the synchronization signals, that are disabled in this configuration.

[Table 1](#) shows the configuration options and restrictions.

**Table 1. svmStdDtXor TPU function set configuration options and restrictions**

TPU function	Optional/Mandatory	How many channels	Assignable channels
svmStdDtXor_R	mandatory	3	any 3 channels
svmStdDtXor_T	mandatory	9	any 9 channels
svmStdDtXor_sync	optional	1 or more	any channels
svmStdDtXor_res	optional	1 or more	any channels
svmStdDtXor_fault	optional	1	any, recommended is 15 and DTPU bit set

Table 2 shows an example of configuration.

Table 2. Example of configuration

Channel	TPU function	Priority
0	svmStdDtXor_T	middle
1	svmStdDtXor_T	middle
2	svmStdDtXor_R	middle
3	svmStdDtXor_T	middle
4	svmStdDtXor_T	middle
5	svmStdDtXor_T	middle
6	svmStdDtXor_R	middle
7	svmStdDtXor_T	middle
8	svmStdDtXor_T	middle
9	svmStdDtXor_T	middle
10	svmStdDtXor_R	middle
11	svmStdDtXor_T	middle
13	svmStdDtXor_sync	low
14	svmStdDtXor_res	low
15	svmStdDtXor_fault	high

Table 3 shows the TPU function code sizes.

Table 3. TPU function code sizes

TPU function	Code size
svmStdDtXor_R	300 $\mu$ instructions + 8 entries = 308 long words
svmStdDtXor_T	3 $\mu$ instructions + 8 entries = 11 long words
svmStdDtXor_sync	26 $\mu$ instructions + 8 entries = 34 long words
svmStdDtXor_res	38 $\mu$ instructions + 8 entries = 46 long words
svmStdDtXor_fault	9 $\mu$ instructions + 8 entries = 17 long words

**Configuration Order**

The CPU configures the TPU as follows.

1. Disables the channels by clearing the two channel priority bits on each channel used (not necessary after reset).
2. Selects the channel functions on all used channels by writing the function numbers to the channel function select bits.
3. Initializes function parameters. The parameters *T*, *prescaler*, *DT*, *SQRT3*, *CPU14* and *sync\_presc\_addr* must be set before initialization. If an svmStdDtXor\_sync channel or an svmStdDtXor\_res channel is used, then its parameters must also be set before initialization.
4. Issues an HSR (Host Service Request) type %10 to one of the svmStdDtXor\_R channels to initialize all svmStdDtXor\_R and svmStdDtXor\_T channels. Issues an HSR type %10 to the

svmStdDtXor\_sync channels, svmStdDtXor\_res channels and svmStdDtXor\_fault channel, if used.

5. Enables servicing by assigning a high, middle or low priority to the channel priority bits. All svmStdDtXor\_R and svmStdDtXor\_T channels must be assigned the same priority to ensure correct operation. The CPU must ensure that the svmStdDtXor\_sync or svmStdDtXor\_res channels are initialized after the initialization of the StdDtXor\_R and svmStdDtXor\_T channels:
  - assign a priority to the StdDtXor\_R and svmStdDtXor\_T channels to enable their initialization
  - if a Synchronization Signal or a Resolver Reference Signal channel is used, wait until the HSR bits are cleared to indicate that initialization of the StdDtXor\_R and svmStdDtXor\_T channels has completed and
  - assign a priority to the svmStdDtXor\_sync or svmStdDtXor\_res channels to enable their initialization

**NOTE:** A CPU routine that configures the TPU can be generated automatically using the MPC500\_Quick\_Start Graphical Configuration Tool.

---

## Detailed Function Description

### Standard Space Vector Modulation with Dead-Time Correction – XOR version – R channels (svmStdDtXor\_R) and Standard Space Vector Modulation with Dead-Time Correction – XOR version – T channels (svmStdDtXor\_T)

The svmStdDtXor\_R and svmStdDtXor\_T TPU functions work together to generate 6 pairs of XOR gate inputs. The XOR gate outputs then produce a 6-channel 3-phase center-aligned PWM signal with dead-time between the top and bottom channels. In order to charge the bootstrap transistors, the PWM signals start to run 1.6ms after their initialization (at 20MHz TCR1 clock). The functions generate signals corresponding to Reference Voltage Vector Amplitude of 0 (50% duty-cycle) until the first reloaded values are processed.

The CPU controls the PWM output by setting the TPU parameters. The Stator Reference Voltage Vector components  $u_a$  and  $u_b$  have to be adjusted during run time. The PWM period  $T$  and the *prescaler* – the number of PWM periods per reload of new values – are also read at each reload, so these parameters can be changed during run time. Conversely, dead-time ( $DT$ ) is not supposed to be changed during run time. The phase currents *currentA*, *currentB* and *currentC* are read by the TPU asynchronously to PWM parameters reload. They are read in the last part of the edge-time calculation to reflect the latest state of the phase currents. The CPU notifies the TPU that the new reload values are prepared by setting the LD\_OK parameter. The TPU notifies the CPU that the reload values have been read and new values can be written by clearing the LD\_OK parameter.

The TPU writes the parameter Sector, which indicates the current Stator Reference Voltage Vector position in sector 1 to 6.

The following figures show the input Stator Reference Voltage Vector components  $u_{\hat{a}}$  and  $u_{\hat{\beta}}$ , corresponding sectors and output PWM signal duty cycle ratios:

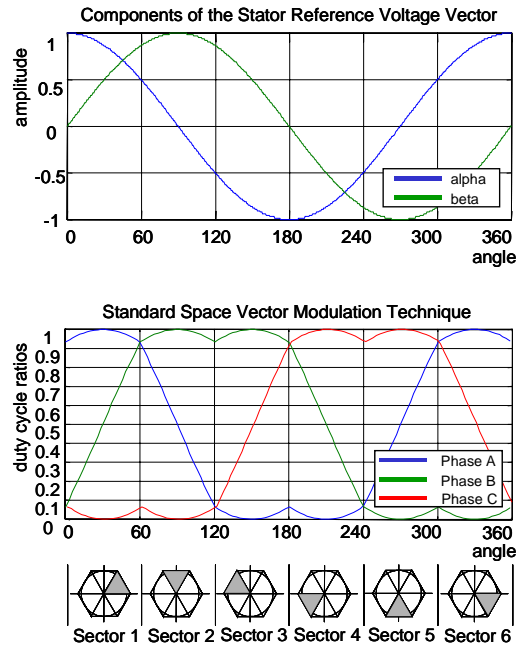

Figure 3. Standard Space Vector Modulation Technique

The following equations describe how the Space Vector Modulation PWM signal high-times  $ht_A$ ,  $ht_B$ ,  $ht_C$  and transition times  $t_{trans}$  of each channel are calculated:

$$U_{\beta} = T \cdot u_{\beta}$$

$$U_{\alpha} = T \cdot u_{\alpha}$$

$$X = U_{\beta}$$

$$Y = \frac{U_{\beta} + U_{\alpha} \sqrt{3}}{2}$$

$$Z = \frac{U_{\beta} - U_{\alpha} \sqrt{3}}{2}$$

	Y < 0			Y >= 0		
	Z < 0	Z >= 0		Z < 0		Z >= 0
		X <= 0	X > 0	X <= 0	X > 0	
<b>Sector:</b>	<b>V.</b>	<b>IV.</b>	<b>III.</b>	<b>VI.</b>	<b>I.</b>	<b>II.</b>

**Phase A:**

Positive current

– T1 channel

$$t_{\text{trans}} = \text{center\_time} - \frac{ht_A}{2}$$

– T2 channel

$$t_{\text{trans}} = \text{center\_time} + \frac{ht_A}{2}$$

– B1 channel

$$t_{\text{trans}} = \text{center\_time} - \frac{ht_A}{2} - DT$$

– B2 channel

$$t_{\text{trans}} = \text{center\_time} + \frac{ht_A}{2} + DT$$

Negative current

– T1 channel

$$t_{\text{trans}} = \text{center\_time} - \frac{ht_A}{2} + DT$$

– T2 channel

$$t_{\text{trans}} = \text{center\_time} + \frac{ht_A}{2} - DT$$

– B1 channel

$$t_{\text{trans}} = \text{center\_time} - \frac{ht_A}{2}$$

– B2 channel

$$t_{\text{trans}} = \text{center\_time} + \frac{ht_A}{2}$$

Phase B and Phase C similarly with  $ht_B$  and  $ht_C$  substituted to  $ht_A$ .



Host Interface

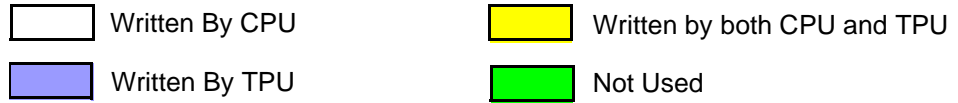

**Table 4. svmStdDtXor\_T Control Bits**







Name	Options
<div style="display: flex; justify-content: space-around; width: 100px;"> <span>3</span><span>2</span><span>1</span><span>0</span> </div>  Channel Function Select	svmStdDtXor_T function number (Assigned during assembly the DPTRAM code from library TPU functions)
<div style="display: flex; justify-content: space-around; width: 60px;"> <span>1</span><span>0</span> </div>  Channel Priority	00 – Channel Disabled 01 – Low Priority 10 – Middle Priority 11 – High Priority
<div style="display: flex; justify-content: space-around; width: 60px;"> <span>1</span><span>0</span> </div>  Host Service Bits (HSR)	00 – No Host Service Request 01 – Not used 10 – Not used 11 – Not used
<div style="display: flex; justify-content: space-around; width: 60px;"> <span>1</span><span>0</span> </div>  Host Sequence Bits (HSQ)	xx – Not used
<div style="display: flex; justify-content: space-around; width: 60px;"> <span>0</span> </div>  Channel Interrupt Enable	x – Not used
<div style="display: flex; justify-content: space-around; width: 60px;"> <span>0</span> </div>  Channel Interrupt Status	x – Not used

Table 5. svmStdDtXor\_R Control Bits

Name	Options
<div style="display: flex; justify-content: space-around; width: 100px;"> <span>3</span><span>2</span><span>1</span><span>0</span> </div> <div style="display: flex; align-items: center;"> <div style="border: 1px solid black; width: 15px; height: 15px; margin-right: 5px;"></div> <div style="border: 1px solid black; width: 15px; height: 15px; margin-right: 5px;"></div> <div style="border: 1px solid black; width: 15px; height: 15px; margin-right: 5px;"></div> <div style="border: 1px solid black; width: 15px; height: 15px;"></div> </div> Channel Function Select	svmStdDtXor_R function number (Assigned during assembly the DPTRAM code from library TPU functions)
<div style="display: flex; justify-content: space-around; width: 100px;"> <span>1</span><span>0</span> </div> <div style="display: flex; align-items: center;"> <div style="border: 1px solid black; width: 15px; height: 15px; margin-right: 5px;"></div> <div style="border: 1px solid black; width: 15px; height: 15px;"></div> </div> Channel Priority	00 – Channel Disabled 01 – Low Priority 10 – Middle Priority 11 – High Priority
<div style="display: flex; justify-content: space-around; width: 100px;"> <span>1</span><span>0</span> </div> <div style="display: flex; align-items: center;"> <div style="border: 1px solid black; width: 15px; height: 15px; margin-right: 5px;"></div> <div style="border: 1px solid black; width: 15px; height: 15px;"></div> </div> Host Service Bits (HSR)	00 – No Host Service Request 01 – Not used 10 – Initialization 11 – Stop
<div style="display: flex; justify-content: space-around; width: 100px;"> <span>1</span><span>0</span> </div> <div style="display: flex; align-items: center;"> <div style="background-color: green; width: 15px; height: 15px; margin-right: 5px;"></div> <div style="background-color: green; width: 15px; height: 15px;"></div> </div> Host Sequence Bits (HSQ)	xx – Not used
<div style="display: flex; justify-content: space-around; width: 100px;"> <span>0</span> </div> <div style="display: flex; align-items: center;"> <div style="border: 1px solid black; width: 15px; height: 15px; margin-right: 5px;"></div> </div> Channel Interrupt Enable	0 – Channel Interrupt Disabled 1 – Channel Interrupt Enabled
<div style="display: flex; justify-content: space-around; width: 100px;"> <span>0</span> </div> <div style="display: flex; align-items: center;"> <div style="background-color: blue; width: 15px; height: 15px; margin-right: 5px;"></div> </div> Channel Interrupt Status	0 – Interrupt Not Asserted 1 – Interrupt Asserted

TPU function svmStdDtXor\_R generates an interrupt when the current values of *Ualfa*, *Ubeta*, *T* and *prescaler* have been read by the TPU and indicates to the CPU that it can write new variables. The CPU program can either wait for this interrupt to occur, or poll the *LD\_OK* bit to check it has cleared. The interrupt is generated at each reload by one of the R channels. The T channels do not generate any interrupts.

**Table 6. svmStdDtXor\_T and svmStdDtXor\_R Parameter RAM**

Channel	Parameter	15	14	13	12	11	10	9	8	7	6	5	4	3	2	1	0	
Phase A T1 channel	0	Ttime_AT1																
	1	T_copy																
	2	prsc_copy																
	3	UA																
	4	Ualfa																
	5	Ubeta																
	6																	
	7	fault_pinstat																
Phase A T2 channel	0	Ttime_AT2																
	1	min_ht																
	2	max_ht																
	3	UB																
	4	LD_OK																
	5	Sector																
	6																	
	7																	
Phase A B1 channel	0	htA																
	1	B2_chan_A																
	2	T1_chan_A																
	3	T2_chan_A																
	4	B1a_chan_A																
	5	B1b_chan_A																
	6	currentA																
	7																	
Phase A B2 channel	0	Ttime_AB2																
	1	state																
	2	center_time																
	3	dec																
	4	T																
	5	prescaler																
	6																	
	7																	
Phase B T1 channel	0	Ttime_BT1																
	1	UA3																
	2																	
	3																	
	4	SQRT3																
	5	sync_presc_addr																
	6																	
	7																	

Table 6. svmStdDtXor\_T and svmStdDtXor\_R Parameter RAM

Channel	Parameter	15	14	13	12	11	10	9	8	7	6	5	4	3	2	1	0	
Phase B T2 channel	0	Time_BT2																
	1																	
	2																	
	3																	
	4	DT																
	5	CPU14																
	6																	
	7																	
Phase B B1 channel	0	htB																
	1	B2_chan_B																
	2	T1_chan_B																
	3	T2_chan_B																
	4	B1a_chan_B																
	5	B1b_chan_B																
	6	currentB																
	7																	
Phase B B2 channel	0	Time_BB2																
	1																	
	2																	
	3																	
	4																	
	5																	
	6																	
	7																	
Phase C T1 channel	0	Time_CT1																
	1																	
	2																	
	3																	
	4																	
	5																	
	6																	
	7																	
Phase C T2 channel	0	Time_CT2																
	1																	
	2																	
	3																	
	4																	
	5																	
	6																	
	7																	

**Table 6. svmStdDtXor\_T and svmStdDtXor\_R Parameter RAM**

Channel	Parameter	15	14	13	12	11	10	9	8	7	6	5	4	3	2	1	0	
Phase C B1 channel	0	htC																
	1	B2_chan_C																
	2	T1_chan_C																
	3	T2_chan_C																
	4	B1a_chan_C																
	5	B1b_chan_C																
	6	currentC																
	7																	
Phase C B2 channel	0	Ttime_CB2																
	1																	
	2																	
	3																	
	4																	
	5																	
	6																	
	7																	

Table 7. svmStdDtXor\_T and svmStdDtXor\_R parameter description

Parameter	Format	Description
Parameters written by CPU		
Ualfa, Ubeta	16-bit fractional	Stator Reference Voltage Vector components
currentA	0 or 1	0 ... positive current on phase A 1 ... negative current on phaseA
currentB	0 or 1	0 ... positive current on phase B 1 ... negative current on phaseB
currentC	0 or 1	0 ... positive current on phase C 1 ... negative current on phaseC
T	16-bit unsigned integer	PWM period in number of TCR1 TPU cycles
prescaler	16-bit unsigned integer	The number of PWM periods per reload of new values
DT	16-bit unsigned integer	Dead-time in number of TCR1 TPU cycles
CPU14	16-bit unsigned integer	Time of 14 IMB clocks in TCR1 clocks.
SQRT3	16-bit fractional	$\sqrt{3}/2 = 0.866 = \$6EDA$ constant
sync_presc_addr	8-bit unsigned integer	address of synchronization channel <i>prescaler</i> parameter: $\$X4$ , where X is synchronization channel number. $\$0$ if no synchronization channel is used.
Parameters written by both TPU and CPU		
LD_OK	1-bit	0 ... CPU can update variables 1 ... TPU can read variables CPU sets 1, TPU sets 0
Parameters written by TPU		
Sector	16-bit unsigned integer	The position of Stator Reference Voltage Vector in a sector. The Sector can be 1, 2, 3, 4, 5 or 6
fault_pinstate	0 or 1	If fault channel is used, state of fault pin: 0 ... low 1 ... high
Other parameters are just for TPU function inner use.		

Performance

**Table 8. svmStdDtXor\_T State Statistics**

State	Max IMB Clock Cycles	RAM Accesses by TPU
ST	2	1
SF	2	0

**Table 9. svmStdDtXor\_R State Statistics**

State	Max IMB Clock Cycles	RAM Accesses by TPU
INIT	154	35
STOP	166	4
SFR <sub>0</sub>	6	1
SFR	44	16
C5	44	15
SFC <sub>0</sub>	6	1
SFC	56	11

**NOTE:** Execution times do not include the time slot transition time (TST = 10 or 14 IMB clocks)

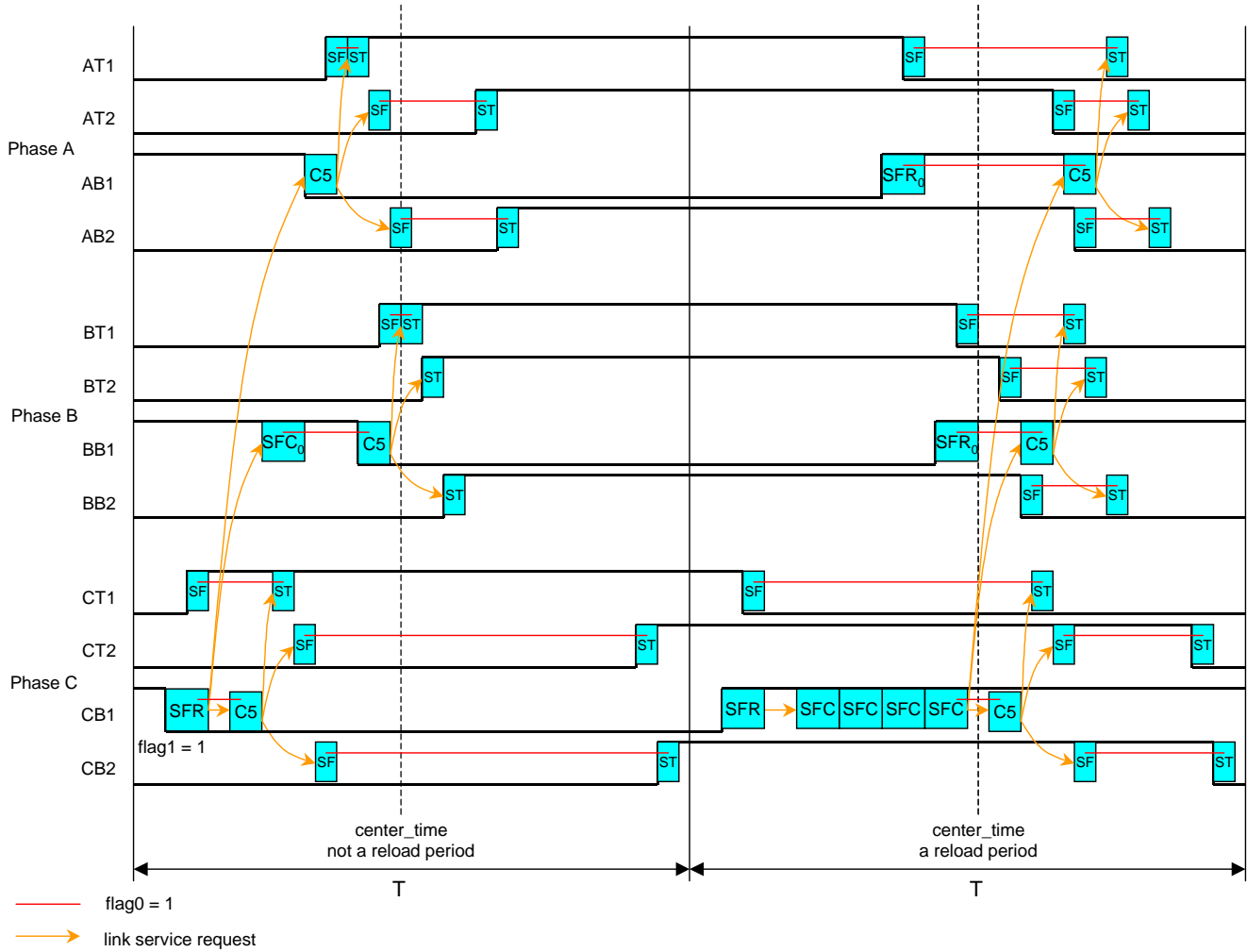

Figure 4. svmStdDtXor\_T and svmStdDtXor\_R timing

**NOTE:** The R channel with the momentary earliest transition within the PWM period is marked by a flag1 and runs the SFR and SFC states.



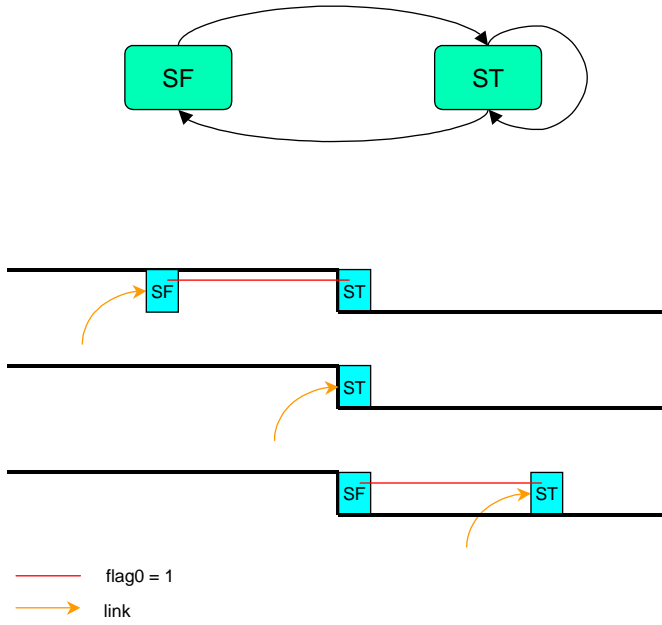

Figure 5. `svmStdDtXor_T` state diagram and 3 cases of timing

*Which case happens is determined by the time when the link comes.*

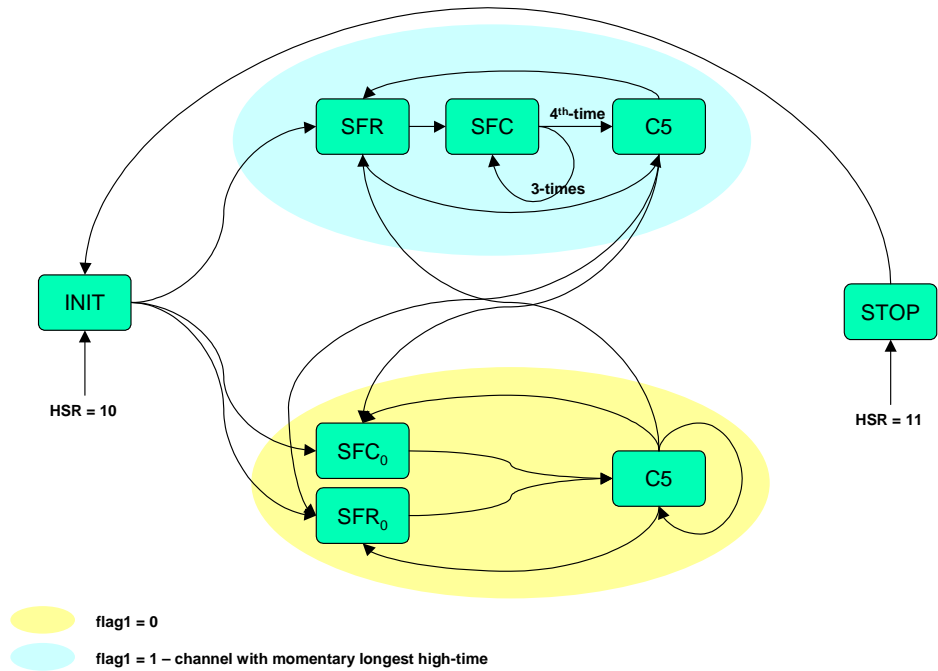

Figure 6. `svmStdDtXor_R` state diagram

**Synchronization signal for Standard Space Vector Modulation with Dead-Time Correction – XOR version (`svmStdDtXor_sync`)**

The `svmStdDtXor_sync` TPU function uses information obtained from `StdDtXor_R` and `svmStdDtXor_T` functions, the actual PWM center times and the PWM periods. This allows a signal to be generated, which tracks the changes in the PWM period and is always synchronized with the PWM. The synchronization signal is a positive pulse generated repeatedly after the *prescaler* or *presc\_copy* PWM periods (see next paragraph). The low to high transition of the pulse can be adjusted by a parameter, either negative or positive, to go a number of TCR1 TPU cycles before or after the PWM period center time. The pulse width *pw* is another synchronization signal parameter.

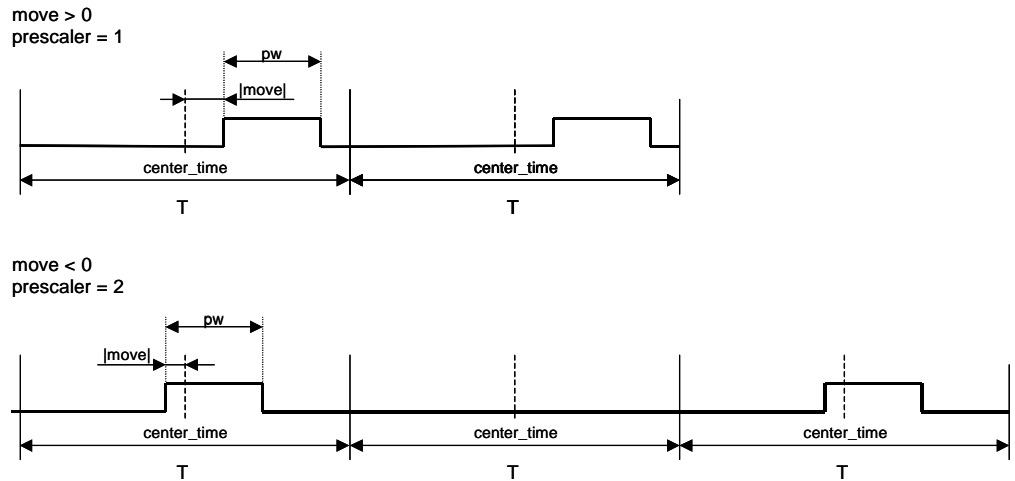

Figure 7. Synchronization signal adjustment examples

Synchronized Change of PWM Prescaler And Synchronization Signal Prescaler

The `svmStdDtXor_sync` TPU function actually uses the `presc_copy` parameter instead of the `prescaler` parameter. The `prescaler` parameter holds the prescaler value that is copied to the `presc_copy` by the `svmStdDtXor_bottom` function at the time the PWM parameters are reloaded. This ensures that new prescaler values for the PWM signals, as well as the synchronization signal, are applied at the same time. Write the synchronization signal `prescaler` parameter address to the `sync_presc_addr` parameter to enable this mechanism. Write 0 to disable it, and remember to set the synchronization signal `presc_copy` parameter instead of the `prescaler` parameter in this case.

Host Interface

- Written By CPU
- Written by both CPU and TPU
- Written By TPU
- Not Used

Table 10. `svmStdDtXor_sync` Control Bits

Name	Options
<div style="display: flex; justify-content: space-around; width: 100px;"> <span>3</span><span>2</span><span>1</span><span>0</span> </div> <div style="display: flex; align-items: center;"> <div style="border: 1px solid black; width: 20px; height: 20px; margin-right: 5px;"></div> <div style="border: 1px solid black; width: 20px; height: 20px; margin-right: 5px;"></div> <div style="border: 1px solid black; width: 20px; height: 20px; margin-right: 5px;"></div> <div style="border: 1px solid black; width: 20px; height: 20px;"></div> </div> Channel Function Select	<code>svmStdDtXor_sync</code> function number (Assigned during assembly the DPTRAM code from library TPU functions)
<div style="display: flex; justify-content: space-around; width: 40px;"> <span>1</span><span>0</span> </div> <div style="display: flex; align-items: center;"> <div style="border: 1px solid black; width: 20px; height: 20px; margin-right: 5px;"></div> <div style="border: 1px solid black; width: 20px; height: 20px;"></div> </div> Channel Priority	00 – Channel Disabled 01 – Low Priority 10 – Middle Priority 11 – High Priority

Table 10. svmStdDtXor\_sync Control Bits

Name	Options
<div style="display: flex; align-items: center;"> <div style="margin-right: 10px;"> <div style="display: flex; justify-content: space-around; width: 20px;"> <span>1</span><span>0</span> </div> <div style="border: 1px solid black; width: 15px; height: 15px; margin: 2px;"></div> <div style="border: 1px solid black; width: 15px; height: 15px; margin: 2px;"></div> </div> <div>Host Service Bits (HSR)</div> </div>	00 – No Host Service Request 01 – Not used 10 – Initialization 11 – Not used
<div style="display: flex; align-items: center;"> <div style="margin-right: 10px;"> <div style="display: flex; justify-content: space-around; width: 20px;"> <span>1</span><span>0</span> </div> <div style="background-color: green; width: 15px; height: 15px; margin: 2px;"></div> <div style="background-color: green; width: 15px; height: 15px; margin: 2px;"></div> </div> <div>Host Sequence Bits (HSQ)</div> </div>	xx – Not used
<div style="display: flex; align-items: center;"> <div style="margin-right: 10px;"> <div style="display: flex; justify-content: center; width: 20px;"> <span>0</span> </div> <div style="border: 1px solid black; width: 15px; height: 15px; margin: 2px;"></div> </div> <div>Channel Interrupt Enable</div> </div>	0 – Channel Interrupt Disabled 1 – Channel Interrupt Enabled
<div style="display: flex; align-items: center;"> <div style="margin-right: 10px;"> <div style="display: flex; justify-content: center; width: 20px;"> <span>0</span> </div> <div style="background-color: blue; width: 15px; height: 15px; margin: 2px;"></div> </div> <div>Channel Interrupt Status</div> </div>	0 – Interrupt Not Asserted 1 – Interrupt Asserted

TPU function svmStdDtXor\_sync generates an interrupt after each low to high transition.

Table 11. svmStdDtXor\_sync Parameter RAM

Channel	Parameter	15	14	13	12	11	10	9	8	7	6	5	4	3	2	1	0
Synchronization channel	0	move															
	1	pw															
	2	prescaler															
	3	presc_copy															
	4	time															
	5	dec															
	6	T_copy															
	7																

Table 12. svmStdDtXor\_sync parameter description

Parameter	Format	Description
Parameters written by CPU		
move	16-bit signed integer	The number of TCR1 TPU cycles to forego (negative) or come after (positive) the PWM period center time
pw	16-bit unsigned integer	Synchronization pulse width in number of TCR1 TPU cycles.

Table 12. svmStdDtXor\_sync parameter description

Parameter	Format	Description
prescaler	16-bit unsigned integer	The number of PWM periods per synchronization pulse – use in case of synchronized prescalers change
presc_copy	16-bit unsigned integer	The number of PWM periods per synchronization pulse – use in case of asynchronized prescalers change
Parameters written by TPU		
Other parameters are just for TPU function inner use.		

Performance

There is one limitation. The absolute value of parameter *move* has to be less than a quarter of the PWM period *T*.

$$|move| < \frac{T}{4}$$

Table 13. svmStdDtXor\_sync State Statistics

State	Max IMB Clock Cycles	RAM Accesses by TPU
INIT	12	5
S1	12	6
S2	8	3
S3	16	7

**NOTE:** Execution times do not include the time slot transition time ( $TST = 10$  or  $14$  IMB clocks)

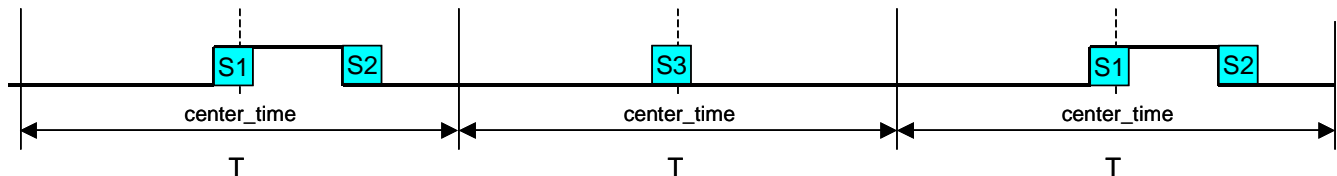

Figure 8. svmStdDtXor\_sync timing

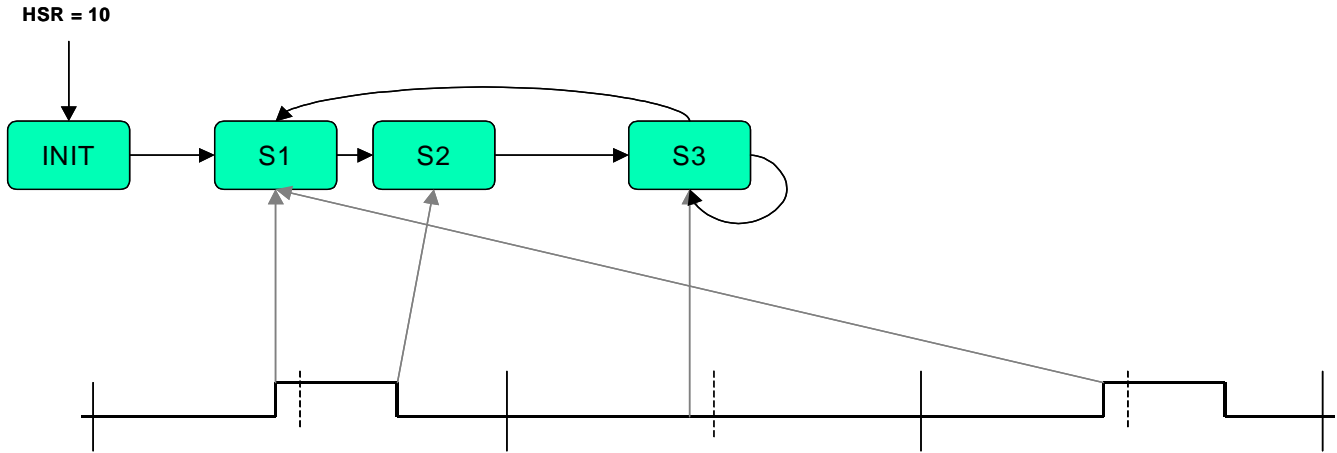
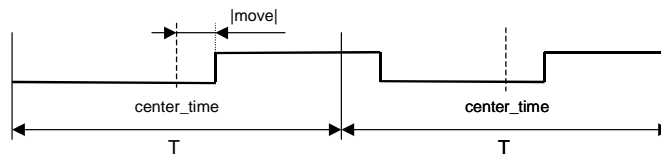

Figure 9. svmStdDtXor\_sync state diagram

**Resolver Reference Signal for Standard Space Vector Modulation with Dead-Time Correction – XOR version (svmStdDtXor\_res)**

The svmStdDtXor\_res TPU function uses information read from the StdDtXor\_R and svmStdDtXor\_T functions, the actual PWM center times and the PWM periods. This allows a signal to be generated, which tracks the changes of the PWM period and is always synchronized with the PWM. The resolver reference signal is a 50% duty-cycle signal with a period equal to *prescaler* or synchronization channel *presc\_copy* PWM periods (see next paragraph). The low to high transition of the pulse can be adjusted by a parameter, either negative or positive, to go a number of TCR1 TPU cycles before or after the PWM period center time.

move > 0  
prescaler = 1



move < 0  
prescaler = 2

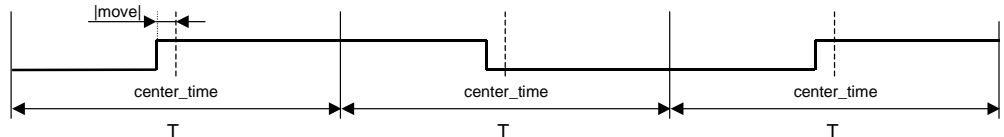

Figure 10. Resolver reference signal adjustment examples

Synchronized Change of PWM Prescaler And Resolver Reference Signals Prescaler

The svmStdDtXor\_res TPU function can inherit the Synchronization Signal prescaler that is synchronously changed with the PWM prescaler. Write the synchronization signals *presc\_copy* parameter address to the *presc\_addr* parameter to enable this mechanism. Write 0 to disable it, and in this case set the *prescaler* parameter to directly specify prescaler value.

Host Interface





 Written By CPU	 Written by both CPU and TPU
 Written By TPU	 Not Used

Table 14. svmStdDtXor\_res Control Bits

Name	Options
<div style="display: flex; justify-content: space-around; width: 100px;"> <span>3</span><span>2</span><span>1</span><span>0</span> </div> <div style="display: flex; align-items: center;"> <div style="border: 1px solid black; width: 15px; height: 15px; margin-right: 5px;"></div> <div style="border: 1px solid black; width: 15px; height: 15px; margin-right: 5px;"></div> <div style="border: 1px solid black; width: 15px; height: 15px; margin-right: 5px;"></div> <div style="border: 1px solid black; width: 15px; height: 15px;"></div> </div> Channel Function Select	svmStdDtXor_res function number (Assigned during assembly the DPTRAM code from library TPU functions)
<div style="display: flex; justify-content: space-around; width: 40px;"> <span>1</span><span>0</span> </div> <div style="display: flex; align-items: center;"> <div style="border: 1px solid black; width: 15px; height: 15px; margin-right: 5px;"></div> <div style="border: 1px solid black; width: 15px; height: 15px;"></div> </div> Channel Priority	00 – Channel Disabled 01 – Low Priority 10 – Middle Priority 11 – High Priority
<div style="display: flex; justify-content: space-around; width: 40px;"> <span>1</span><span>0</span> </div> <div style="display: flex; align-items: center;"> <div style="border: 1px solid black; width: 15px; height: 15px; margin-right: 5px;"></div> <div style="border: 1px solid black; width: 15px; height: 15px;"></div> </div> Host Service Bits (HSR)	00 – No Host Service Request 01 – Not used 10 – Initialization 11 – Not used
<div style="display: flex; justify-content: space-around; width: 40px;"> <span>1</span><span>0</span> </div> <div style="display: flex; align-items: center;"> <div style="background-color: green; width: 15px; height: 15px; margin-right: 5px;"></div> <div style="background-color: green; width: 15px; height: 15px;"></div> </div> Host Sequence Bits (HSQ)	xx – Not used
<div style="display: flex; justify-content: space-around; width: 40px;"> <span>0</span> </div> <div style="display: flex; align-items: center;"> <div style="background-color: green; width: 15px; height: 15px; margin-right: 5px;"></div> </div> Channel Interrupt Enable	x – Not used
<div style="display: flex; justify-content: space-around; width: 40px;"> <span>0</span> </div> <div style="display: flex; align-items: center;"> <div style="background-color: green; width: 15px; height: 15px; margin-right: 5px;"></div> </div> Channel Interrupt Status	x – Not used

Table 15. svmStdDtXor\_res Parameter RAM

Channel	Parameter	15	14	13	12	11	10	9	8	7	6	5	4	3	2	1	0	
Resolver	0	move																
	1																	
	2	presc_addr																
	3	prescaler																
	4	time																
	5	dec																
	6	T_copy																
	7																	

Table 16. svmStdDtXor\_res parameter description

Parameter	Format	Description
Parameters written by CPU		
move	16-bit signed integer	The number of TCR1 TPU cycles to forego (negative) or come after (positive) the PWM period center time
presc_addr	16-bit unsigned integer	\$00X6, where X is a number of Synchronization Signal channel, to inherit Sync. channel prescaler or \$0000 to enable direct specification of prescaler value in prescaler parameter
prescaler	1, 2, 4, 6, 8, 10, 12, 14, ...	The number of PWM periods per synchronization pulse – use when apresc_addr = 0
Parameters written by TPU		
Other parameters are just for TPU function inner use.		

Performance

There is one limitation. The absolute value of parameter *move* has to be less than a quarter of the PWM period *T*.

$$|move| < \frac{T}{4}$$

Table 17. svmStdDtXor\_res State Statistics

State	Max IMB Clock Cycles	RAM Accesses by TPU
INIT	12	5



Table 17. svmStdDtXor\_res State Statistics

State	Max IMB Clock Cycles	RAM Accesses by TPU
S1	26	9
S3	18	7

**NOTE:** Execution times do not include the time slot transition time ( $TST = 10$  or  $14$  IMB clocks)

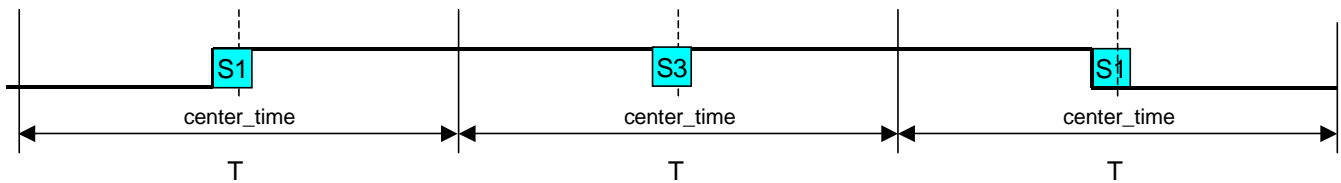

Figure 11. svmStdDtXor\_res timing

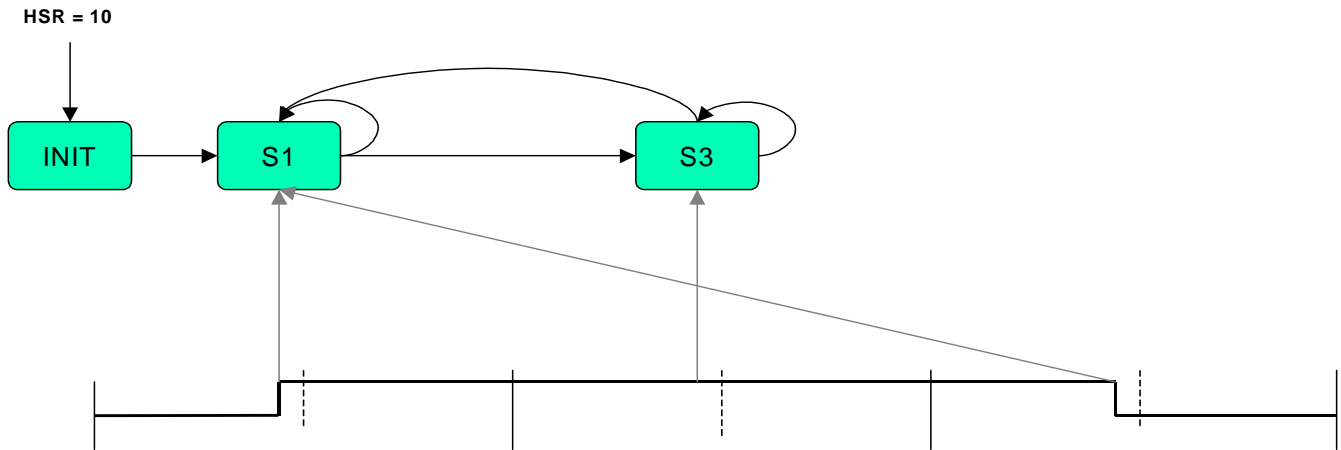

Figure 12. svmStdDtXor\_res state diagram

**Fault Input for Standard Space Vector Modulation with Dead-Time Correction – XOR version (svmStdDtXor\_fault)**

The svmStdDtXor\_fault is an input TPU function that monitors the pin, and if a high to low transition occurs, immediately sets all PWM channels low and cancels all further transitions on them. The PWM channels, as well as the synchronization and resolver reference signal channels (if used), have to be initialized again to start them running.

The function returns the actual pinstate as a value of 0 (low) or 1 (high) in the parameter *fault\_pinstate*. The parameter is placed on the AT1 channel to keep the fault channel parameter space free.

Host Interface

<input type="checkbox"/>	Written By CPU	<input type="checkbox"/>	Written by both CPU and TPU
<input type="checkbox"/>	Written By TPU	<input type="checkbox"/>	Not Used

Table 18. svmStdDtXor\_fault Control Bits

Name	Options
<div style="display: flex; justify-content: space-around; width: 100px;"> <span>3</span><span>2</span><span>1</span><span>0</span> </div> <div style="display: flex; align-items: center;"> <div style="border: 1px solid black; width: 15px; height: 15px; margin-right: 5px;"></div> <div style="border: 1px solid black; width: 15px; height: 15px; margin-right: 5px;"></div> <div style="border: 1px solid black; width: 15px; height: 15px; margin-right: 5px;"></div> <div style="border: 1px solid black; width: 15px; height: 15px;"></div> </div> Channel Function Select	svmStdDtXor_fault function number (Assigned during assembly the DPTRAM code from library TPU functions)
<div style="display: flex; justify-content: space-around; width: 100px;"> <span>1</span><span>0</span> </div> <div style="display: flex; align-items: center;"> <div style="border: 1px solid black; width: 15px; height: 15px; margin-right: 5px;"></div> <div style="border: 1px solid black; width: 15px; height: 15px;"></div> </div> Channel Priority	00 – Channel Disabled 01 – Low Priority 10 – Middle Priority 11 – High Priority
<div style="display: flex; justify-content: space-around; width: 100px;"> <span>1</span><span>0</span> </div> <div style="display: flex; align-items: center;"> <div style="border: 1px solid black; width: 15px; height: 15px; margin-right: 5px;"></div> <div style="border: 1px solid black; width: 15px; height: 15px;"></div> </div> Host Service Bits (HSR)	00 – No Host Service Request 01 – Not used 10 – Initialization 11 – Not used
<div style="display: flex; justify-content: space-around; width: 100px;"> <span>1</span><span>0</span> </div> <div style="display: flex; align-items: center;"> <div style="background-color: green; width: 15px; height: 15px; margin-right: 5px;"></div> <div style="background-color: green; width: 15px; height: 15px;"></div> </div> Host Sequence Bits (HSQ)	xx – Not used
<div style="display: flex; justify-content: space-around; width: 100px;"> <span>0</span> </div> <div style="display: flex; align-items: center;"> <div style="border: 1px solid black; width: 15px; height: 15px; margin-right: 5px;"></div> </div> Channel Interrupt Enable	0 – Channel Interrupt Disabled 1 – Channel Interrupt Enabled
<div style="display: flex; justify-content: space-around; width: 100px;"> <span>0</span> </div> <div style="display: flex; align-items: center;"> <div style="background-color: blue; width: 15px; height: 15px; margin-right: 5px;"></div> </div> Channel Interrupt Status	0 – Interrupt Not Asserted 1 – Interrupt Asserted

TPU function svmStdDtXor\_fault generates an interrupt when a high to low transition appears.

Table 19. svmStdDtXor\_fault Parameter RAM

Channel	Parameter	15	14	13	12	11	10	9	8	7	6	5	4	3	2	1	0	
Fault input	0																	
	1																	
	2																	
	3																	
	4																	
	5																	
	6																	
	7																	

Table 20. svmStdDtXor\_fault parameter description

Parameter	Format	Description
Parameters written by TPU		
fault_pinstate	0 or 1	State of fault pin: 0 ... low 1 ... high

Performance

Table 21. svmStdDtXor\_fault State Statistics

State	Max IMB Clock Cycles	RAM Accesses by TPU
INIT	8	2
FAULT	172	5
NO_FAULT	4	1

**NOTE:** Execution times do not include the time slot transition time (TST = 10 or 14 IMB clocks)

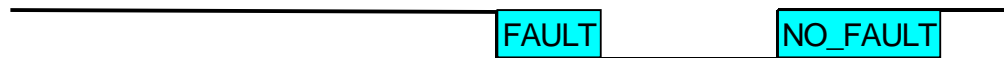

Figure 13. svmStdDtXor\_fault timing

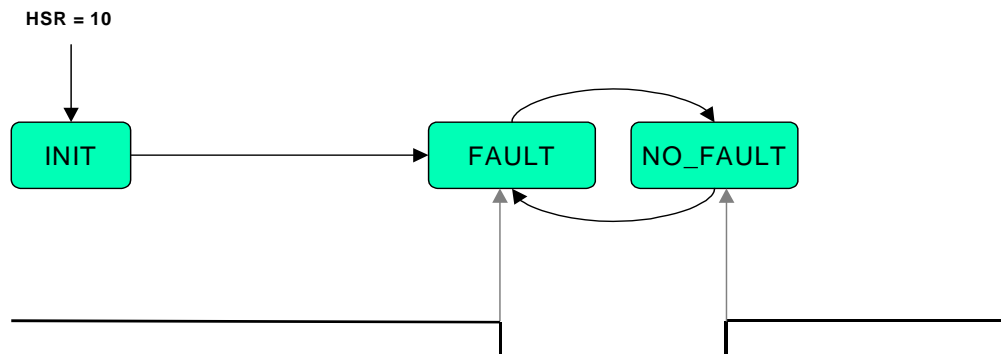

Figure 14. svmStdDtXor\_fault state diagram

## HOW TO REACH US:

### USA/EUROPE/LOCATIONS NOT LISTED:

Motorola Literature Distribution  
P.O. Box 5405  
Denver, Colorado 80217  
1-800-521-6274 or 480-768-2130

### JAPAN:

Motorola Japan Ltd.  
SPS, Technical Information Center  
3-20-1, Minami-Azabu, Minato-ku  
Tokyo 106-8573, Japan  
81-3-3440-3569

### ASIA/PACIFIC:

Motorola Semiconductors H.K. Ltd.  
Silicon Harbour Centre  
2 Dai King Street  
Tai Po Industrial Estate  
Tai Po, N.T., Hong Kong  
852-26668334

### HOME PAGE:

<http://motorola.com/semiconductors>



Information in this document is provided solely to enable system and software implementers to use Motorola products. There are no express or implied copyright licenses granted hereunder to design or fabricate any integrated circuits or integrated circuits based on the information in this document.

Motorola reserves the right to make changes without further notice to any products herein. Motorola makes no warranty, representation or guarantee regarding the suitability of its products for any particular purpose, nor does Motorola assume any liability arising out of the application or use of any product or circuit, and specifically disclaims any and all liability, including without limitation consequential or incidental damages. "Typical" parameters that may be provided in Motorola data sheets and/or specifications can and do vary in different applications and actual performance may vary over time. All operating parameters, including "Typicals", must be validated for each customer application by customer's technical experts. Motorola does not convey any license under its patent rights nor the rights of others. Motorola products are not designed, intended, or authorized for use as components in systems intended for surgical implant into the body, or other applications intended to support or sustain life, or for any other application in which the failure of the Motorola product could create a situation where personal injury or death may occur. Should Buyer purchase or use Motorola products for any such unintended or unauthorized application, Buyer shall indemnify and hold Motorola and its officers, employees, subsidiaries, affiliates, and distributors harmless against all claims, costs, damages, and expenses, and reasonable attorney fees arising out of, directly or indirectly, any claim of personal injury or death associated with such unintended or unauthorized use, even if such claim alleges that Motorola was negligent regarding the design or manufacture of the part.

MOTOROLA and the Stylized M Logo are registered in the US Patent and Trademark Office. All other product or service names are the property of their respective owners. Motorola, Inc. is an Equal Opportunity/Affirmative Action Employer.

© Motorola Inc. 2003

AN2531/D  
Rev. 0  
5/2003

**For More Information On This Product,  
Go to: [www.freescale.com](http://www.freescale.com)**