

# DATA SHEET

Part No.	AN26131A
Package Code No.	XLGA012-L-0303

---

## Contents

■ Overview .....	3
■ Features .....	3
■ Applications .....	3
■ Package .....	3
■ Type .....	3
■ Application Circuit Example (Block Diagram) .....	4
■ Pin Descriptions .....	5
■ Absolute Maximum Ratings .....	6
■ Operating Supply Voltage Range .....	6
■ Allowable Voltage Range .....	7
■ Electrical Characteristics .....	8
■ Control Pin Mode Table .....	10
■ Truth Table .....	10
■ Technical Data .....	11
• I/O block circuit diagrams and pin function descriptions .....	11
• $P_D$ — $T_a$ diagram .....	12
■ Usage Notes .....	13

# AN26131A

Loop through Amplifier IC for VHF & UHF Band (40 MHz to 900 MHz) Applications

## ■ Overview

- AN26131A is a Loop through amplifier IC for VHF and UHF band (40 MHz to 900 MHz) applications.
- Realizing high performance by using 0.30  $\mu\text{m}$  Bi-CMOS process ( $f_T = 20 \text{ GHz}$ ,  $f_{\text{max}} = 20 \text{ GHz}$ ).
- Off and Loop through mode is Changeable, Controlled by Integrated CMOS logic circuit.
- Achieving miniaturization by using small size package.

## ■ Features

- 1-IN, 4-OUT Active Loop through.
- Operation voltage +3.30 V typ.
- Current consumption 110 mA typ. (Loop through mode)  
0.1  $\mu\text{A}$  typ. (Off through mode)
- High Gain Mode
 

RF_OUT1	2.5 dB typ.	fRX = 550 MHz,	$Z_0 = 50 \Omega$
RF_OUT2	2.5 dB typ.	fRX = 550 MHz,	$Z_0 = 50 \Omega$
RF_OUT3	2.5 dB typ.	fRX = 550 MHz,	$Z_0 = 50 \Omega$
RF_OUT4	1.0 dB typ.	fRX = 550 MHz,	$Z_0 = 50 \Omega$
- Low Gain Mode RF\_OUT4 -3.0 dB typ. fRX = 550 MHz,  $Z_0 = 50 \Omega$
- Low noise figure RF\_OUT1 3.5 dB typ. fRX = 550 MHz,  $Z_0 = 50 \Omega$
- Low distortion HG(IIP3) RF\_OUT1 9.0 dBm typ. fRX = 550 MHz,  $Z_0 = 50 \Omega$   
ATT(IIP3) RF\_OUT1 28.0 dBm typ. fRX = 550 MHz,  $Z_0 = 50 \Omega$
- Small package (12 pin Plastic Package).

## ■ Applications

- VHF & UHF band (40 MHz to 900 MHz) applications

## ■ Package

- 12 pin Fine Pitch Land Grid Array Package (LGA Type)  
Size : 3.00 mm  $\times$  2.50 mm  $\times$  0.80 mm

## ■ Type

- Bi-CMOS IC

■ Application Circuit Example (Block Diagram)

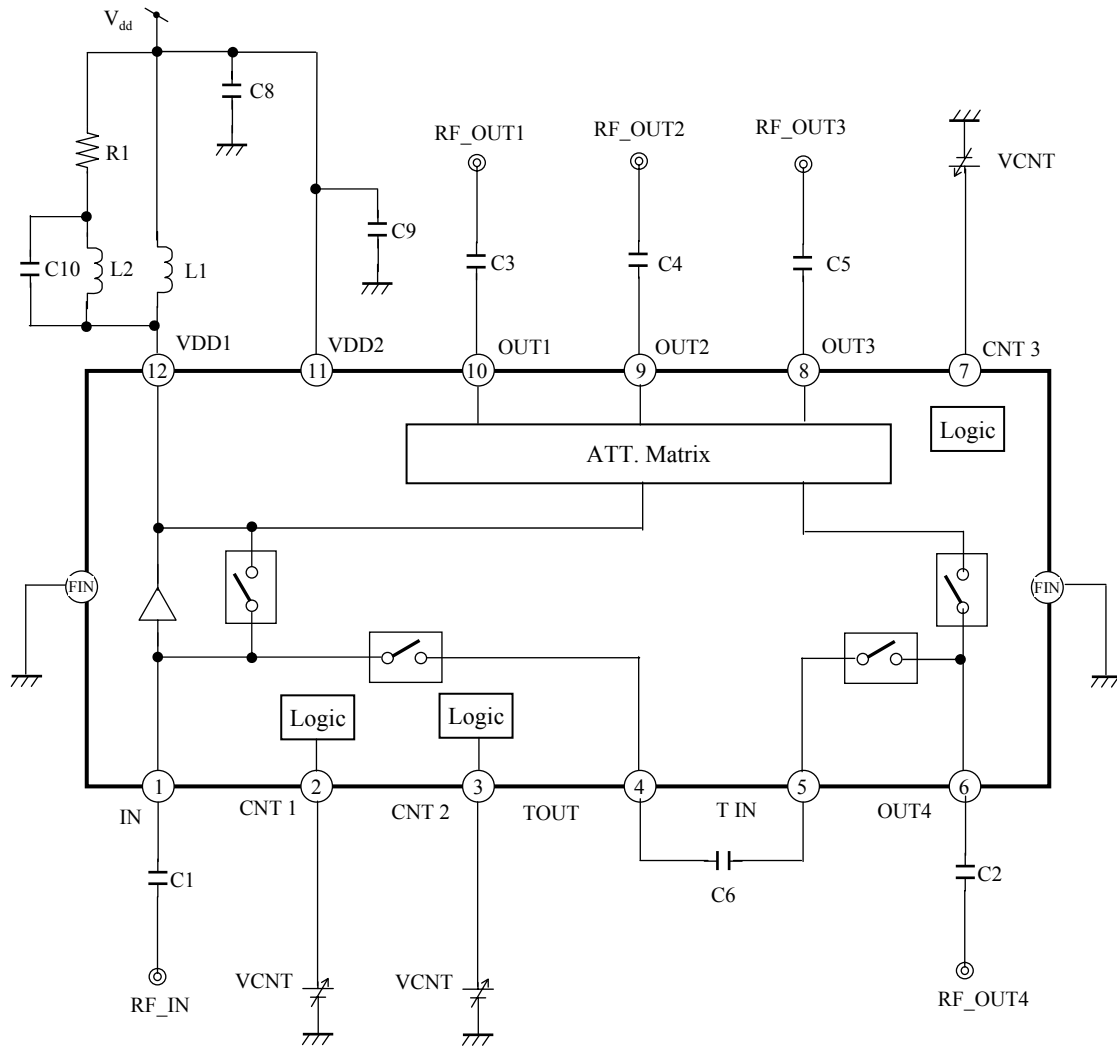

- Notes)
- This application circuit is an example. The operation of mass production set is not guaranteed. You should perform enough evaluation and verification on the design of mass production set. You are fully responsible for the incorporation of the above application circuit and information in the design of your equipment.
  - This block diagram is for explaining functions. Part of the block diagram may be omitted, or it may be simplified.

## ■ Pin Descriptions

Pin No.	Pin name	Type	Description
1	IN	Input	$V_{SS}$
2	CNT 1	Input	Off and Loop through mode control input
3	CNT 2	Input	AMP ON/Off control input
4	TOUT	Output	Trans output
5	TIN	Input	Trans input
6	OUT4	Output	RF output 4
7	CNT 3	Output	Gain control input
8	OUT 3	Output	RF output 3
9	OUT 2	Output	RF output 2
10	OUT 1	Output	RF output 1
11	$V_{DD2}$	Power supply	$V_{DD}$
12	$V_{DD1}$	Power supply	$V_{DD}$
FIN	$V_{SS}$	Ground	$V_{SS}$

### ■ Absolute Maximum Ratings

Note) Absolute maximum ratings are limit values which do not result in damages to this IC, and IC operation is not guaranteed at these limit values.

A No.	Parameter	Symbol	Rating	Unit	Notes
1	Supply voltage	$V_{DD}$	3.6	V	*1
2	Supply current	$I_{DD}$	150	mA	—
3	Power dissipation	$P_D$	147.9	mW	*2
4	Operating ambient temperature	$T_{opr}$	-20 to +80	°C	*3
5	Storage temperature	$T_{stg}$	-40 to +150	°C	*3

Notes) \*1 : The values under the condition not exceeding the above absolute maximum ratings and the power dissipation.

\*2 : The power dissipation shown is the value at  $T_a = 80^\circ\text{C}$  for the independent (unmounted) IC package without a heat sink.

When using this IC, refer to •  $P_D - T_a$  diagram in the ■ Technical Data and design the heat radiation with sufficient margin so that the allowable value might not be exceeded based on the conditions of power supply voltage, load, and ambient temperature.

\*3 : Except for the power dissipation, operating ambient temperature, and storage temperature, all ratings are for  $T_a = 25^\circ\text{C}$ .

### ■ Operating Supply Voltage Range

Parameter	Symbol	Range	Unit	Notes
Supply voltage range	$V_{DD}$	3.13 to 3.47	V	*1

Note) \*1 : The values under the condition not exceeding the above absolute maximum ratings and the power dissipation.

### ■ Allowable Voltage Range

Notes) • Allowable current and voltage ranges are limit ranges which do not result in damages to this IC, and IC operation is not guaranteed within these limit ranges.

- Do not apply voltage to N.C. pins.
- Voltage values are with respect to the GND.
- Applying external voltage to any pin not mentioned below leads to the malfunction and the damage of the device.
- Below ratings are specified for prevention of malfunction and stress, not for guaranteed operation.

Pin No.	Pin name	Rating	Unit	Notes
1	IN	—	V	*1
2	CNT1	- 0.3 to ( $V_{DD} + 0.3$ )	V	*4
3	CNT2	- 0.3 to ( $V_{DD} + 0.3$ )	V	*4
4	TOUT	—	V	*2
5	TIN	—	V	*1
6	OUT4	—	V	*2
7	CNT3	- 0.3 to ( $V_{DD} + 0.3$ )	V	*4
8	OUT3	—	V	*2
9	OUT2	—	V	*2
10	OUT1	—	V	*2
11	$V_{DD2}$	( $V_{DD} - 0.17$ ) to ( $V_{DD} + 0.17$ )	V	—
12	$V_{DD1}$	( $V_{DD} - 0.17$ ) to ( $V_{DD} + 0.17$ )	V	*3

Notes) \*1 : RF signal input pin (Maximum input power is 0 dBm). Do not apply DC current.

\*2 : RF signal output pin. Do not apply DC current.

\*3 : Do not apply a voltage different from  $V_{DD}$  voltage.

\*4 :  $V_{DD} + 0.3$  V must not be exceeded 3.6 V.

■ Electrical Characteristics at  $V_{DD} = 3.30\text{ V}$

Note)  $T_a = 25^\circ\text{C} \pm 2^\circ\text{C}$  unless otherwise specified.

B No.	Parameter	Symbol	Conditions	Limits			Unit	Notes
				Min	Typ	Max		
DC Electrical Characteristics								
DC-1	Supply current HG	$I_{DDHG}$	$V_{DD}$ current at High Gain mode No input signal	70	110	150	mA	—
DC-2	Supply current LG	$I_{DDL G}$	$V_{DD}$ current at Low Gain mode No input signal	70	110	150	mA	—
DC-3	Supply current ATT	$I_{DDATT}$	$V_{DD}$ current at ATT mode No input signal	—	0.1	20	$\mu\text{A}$	—
DC-4	Supply current OT	$I_{DDOT}$	$V_{DD}$ current at OT mode No input signal	—	0.1	20	$\mu\text{A}$	—
DC-5	SW voltage	$V_{IH}$	$V_{IH} = V_{DD} \times 0.85$	2.805	3.30	—	V	—
DC-6	SW voltage	$V_{IL}$	$V_{IL} = V_{DD} \times 0.10$	—	0.0	0.33	V	—
DC-7	SW current (High)	$I_{IH}$	Current at CNT pin $V_{IH} = V_{DD}$	—	3.3	10	$\mu\text{A}$	—



■ Electrical Characteristics (continued) at  $V_{DD} = 3.30\text{ V}$

Note)  $T_a = 25^\circ\text{C} \pm 2^\circ\text{C}$ ,  $f_{RX} = 550\text{ MHz}$ ,  $PRX = -15\text{ dBm}$ ,  $Z_0 = 50\ \Omega$ , CW unless otherwise specified.

B No.	Parameter	Symbol	Conditions	Limits			Unit	Notes
				Min	Typ	Max		
AC Electrical Characteristics								
A-1	LT Power Gain HG	LGHG	Loop through High Gain mode $f = f_{RX}$	-1.5	1.0	3.5	dB	—
A-2	LT Power Gain LG	LTLG	Loop through Low Gain mode $f = f_{RX}$	-5.5	-3.0	-0.5	dB	—
A-3	OT Insertion Loss	IL51	Off through Insertion Loss	-6.0	-3.5	-1.0	dB	—
A-4	SPL Power Gain	SPLPG	Splitter Mode Power Gain	0.0	2.5	5.0	dB	—
A-5	LT ATT	LTATT	Loop through ATT Mode	-22.5	-20	-17.5	dB	—
A-6	SPL ATT	SPLATT	Splitter ATT Mode $f = f_{RX}$	-21.5	-19	-16.5	dB	—
A-7	LT IIP3 HG + 10 MHz offset OUT1 Loop through	LTIIIP3HG	Loop through mode OUT1 $f1 = f_{RX}$ $f2 = f_{RX} + 10\text{ MHz}$ Input 2 signals ( $f1, f2$ )	5	9	—	dBm	—

### ■ Control Pin Mode Table

Note) Control voltage range : See B No. DC-3 / B No. DC-4 at page 8

Pin No.	Description	Pin voltage		Remarks
		Low	High	
2	Loop through/Off through Switching (Mode Control)	Off through	Loop through	—
3	ATT Mode Switching (Mode Control)	AMP active	ATT mode	—
7	Gain control Switching (Mode Control)	High Gain	Low Gain	—

### ■ Truth Table

Note) Control voltage range : See B No. DC-3 / B No. DC-4 at page 8

CNT1	CNT2	CNT3	Splitter Out	Loop Through Out
High	High	High	ATT Mode	ATT Mode
High	High	Low	ATT Mode	ATT Mode
High	Low	High	AMP Active Mode	Low Gain Mode
High	Low	Low	AMP Active Mode	High Gain Mode
Low	Low	High	Off Mode	Off Through Mode
Low	Low	Low	Off Mode	Off Through Mode

■ Technical Data

- I/O block circuit diagrams and pin function descriptions

Note) The characteristics listed below are reference values derived from the design of the IC and are not guaranteed.

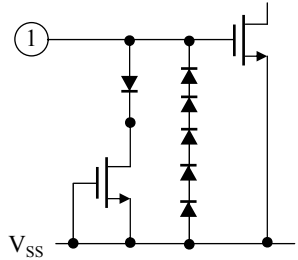
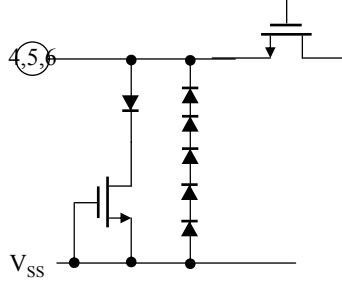
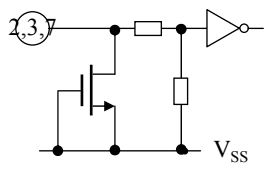
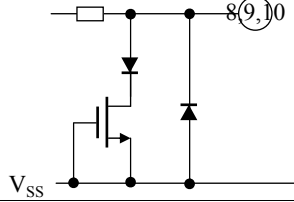
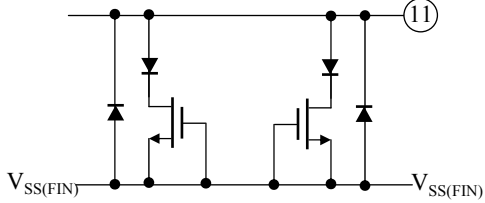
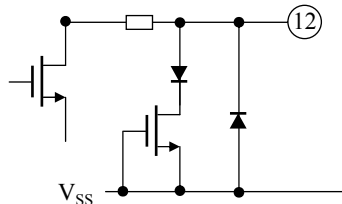
Pin No.1	Voltage	Internal Circuit	Descriptions
1	1.4 V		IN (RF input) OTOOUT (Loop through output), LTOOUT (Off through output)
4, 5, 6	—		TOUT (Off through output), TIN (Off through input), OUT4(RF output)
FIN	0.0 V	—	V <sub>SS</sub> (Ground)
2, 3, 7	3.3 V		CNT (Off through/HG/LG/ATT mode control input)
8, 9, 10	3.3 V		OUT1, OUT2, OUT3 (RF output)
11	3.3 V		V <sub>DD</sub> (Power supply)
12	3.3 V		V <sub>DD</sub> (Power supply)

■ Technical Data (continued)

- $P_D - T_a$  diagram

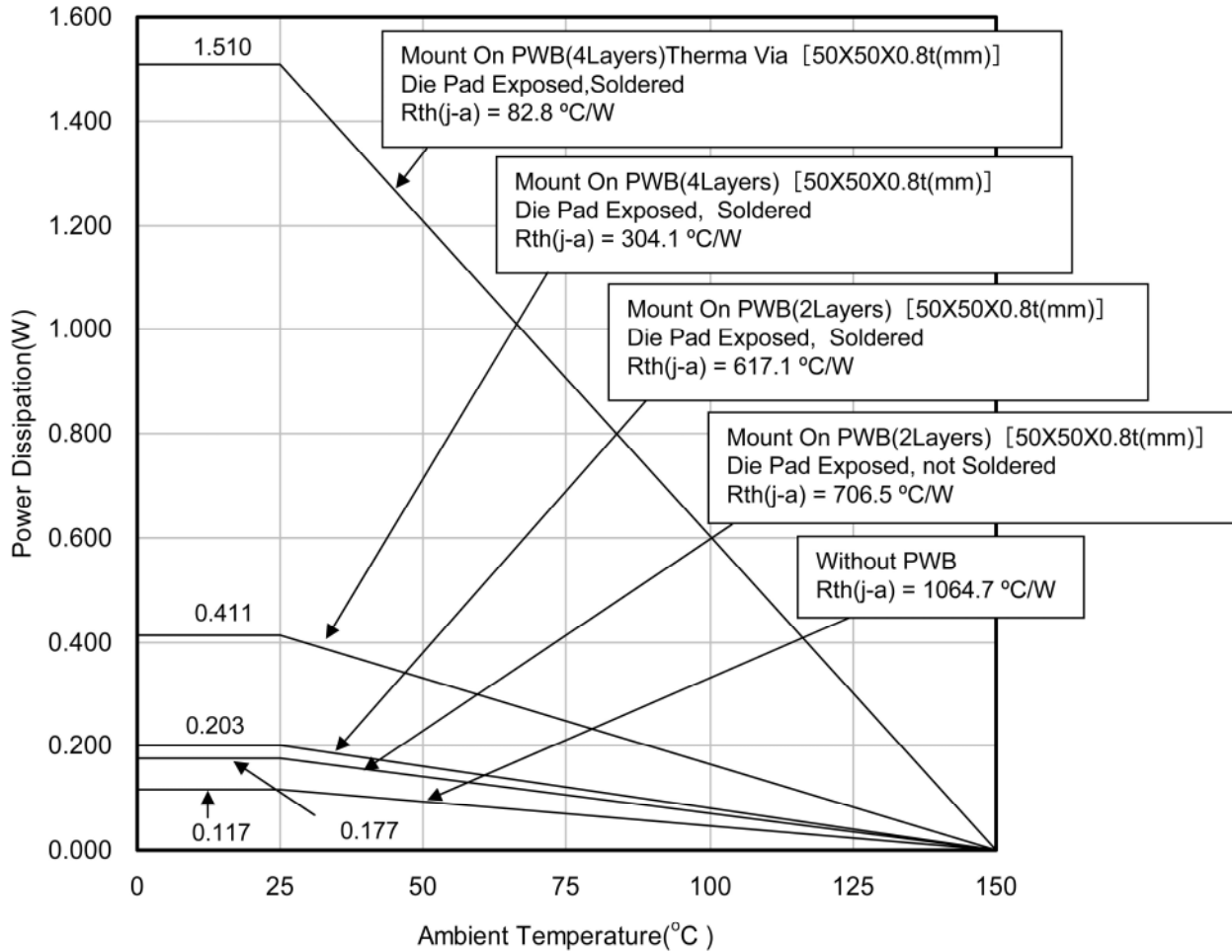

Mount On PWB(4Layers)Therma Via [50X50X0.8t(mm)]  
 Die Pad Exposed,Soldered  
 $R_{th(j-c)} = 14.5 \text{ } ^\circ\text{C/W}$

Mount On PWB(4Layers) [50X50X0.8t(mm)]  
 Die Pad Exposed, Soldered  
 $R_{th(j-c)} = 44.9 \text{ } ^\circ\text{C/W}$

## ■ Usage Notes

### • Special attention and precaution in using

1. This IC is intended to be used for general electronic equipment [TV].

Consult our sales staff in advance for information on the following applications:

- Special applications in which exceptional quality and reliability are required, or if the failure or malfunction of this IC may directly jeopardize life or harm the human body.
- Any applications other than the standard applications intended.
  - (1) Space appliance (such as artificial satellite, and rocket)
  - (2) Traffic control equipment (such as for automobile, airplane, train, and ship)
  - (3) Medical equipment for life support
  - (4) Submarine transponder
  - (5) Control equipment for power plant
  - (6) Disaster prevention and security device
  - (7) Weapon
  - (8) Others : Applications of which reliability equivalent to (1) to (7) is required

It is to be understood that our company shall not be held responsible for any damage incurred as a result of or in connection with your using the IC described in this book for any special application, unless our company agrees to your using the IC in this book for any special application.

2. Pay attention to the direction of LSI. When mounting it in the wrong direction onto the PCB (printed-circuit-board), it might smoke or ignite.
3. Pay attention in the PCB (printed-circuit-board) pattern layout in order to prevent damage due to short circuit between pins. In addition, refer to the Pin Description for the pin configuration.
4. Perform a visual inspection on the PCB before applying power, otherwise damage might happen due to problems such as a solder-bridge between the pins of the semiconductor device. Also, perform a full technical verification on the assembly quality, because the same damage possibly can happen due to conductive substances, such as solder ball, that adhere to the LSI during transportation.
5. Take notice in the use of this product that it might break or occasionally smoke when an abnormal state occurs such as output pin- $V_{CC}$  short (Power supply fault), output pin-GND short (Ground fault), or output-to-output-pin short (load short) .  
And, safety measures such as an installation of fuses are recommended because the extent of the above-mentioned damage and smoke emission will depend on the current capability of the power supply.
6. When designing your equipment, comply with the range of absolute maximum rating and the guaranteed operating conditions (operating power supply voltage and operating environment etc.). Especially, please be careful not to exceed the range of absolute maximum rating on the transient state, such as power-on, power-off and mode-switching. Otherwise, we will not be liable for any defect which may arise later in your equipment.  
Even when the products are used within the guaranteed values, take into the consideration of incidence of break down and failure mode, possible to occur to semiconductor products. Measures on the systems such as redundant design, arresting the spread of fire or preventing glitch are recommended in order to prevent physical injury, fire, social damages, for example, by using the products.
7. When using the LSI for new models, verify the safety including the long-term reliability for each product.
8. When the application system is designed by using this LSI, be sure to confirm notes in this book.  
Be sure to read the notes to descriptions and the usage notes in the book.

## Request for your special attention and precautions in using the technical information and semiconductors described in this book

- (1) If any of the products or technical information described in this book is to be exported or provided to non-residents, the laws and regulations of the exporting country, especially, those with regard to security export control, must be observed.
- (2) The technical information described in this book is intended only to show the main characteristics and application circuit examples of the products. No license is granted in and to any intellectual property right or other right owned by Panasonic Corporation or any other company. Therefore, no responsibility is assumed by our company as to the infringement upon any such right owned by any other company which may arise as a result of the use of technical information described in this book.
- (3) The products described in this book are intended to be used for general applications (such as office equipment, communications equipment, measuring instruments and household appliances), or for specific applications as expressly stated in this book.  
Consult our sales staff in advance for information on the following applications:
  - Special applications (such as for airplanes, aerospace, automotive equipment, traffic signaling equipment, combustion equipment, life support systems and safety devices) in which exceptional quality and reliability are required, or if the failure or malfunction of the products may directly jeopardize life or harm the human body.It is to be understood that our company shall not be held responsible for any damage incurred as a result of or in connection with your using the products described in this book for any special application, unless our company agrees to your using the products in this book for any special application.
- (4) The products and product specifications described in this book are subject to change without notice for modification and/or improvement. At the final stage of your design, purchasing, or use of the products, therefore, ask for the most up-to-date Product Standards in advance to make sure that the latest specifications satisfy your requirements.
- (5) When designing your equipment, comply with the range of absolute maximum rating and the guaranteed operating conditions (operating power supply voltage and operating environment etc.). Especially, please be careful not to exceed the range of absolute maximum rating on the transient state, such as power-on, power-off and mode-switching. Otherwise, we will not be liable for any defect which may arise later in your equipment.  
Even when the products are used within the guaranteed values, take into the consideration of incidence of break down and failure mode, possible to occur to semiconductor products. Measures on the systems such as redundant design, arresting the spread of fire or preventing glitch are recommended in order to prevent physical injury, fire, social damages, for example, by using the products.
- (6) Comply with the instructions for use in order to prevent breakdown and characteristics change due to external factors (ESD, EOS, thermal stress and mechanical stress) at the time of handling, mounting or at customer's process. When using products for which damp-proof packing is required, satisfy the conditions, such as shelf life and the elapsed time since first opening the packages.
- (7) This book may be not reprinted or reproduced whether wholly or partially, without the prior written permission of our company.