

37V/1.0A&1.7A Dual Microstepping Motor Driver

FEATURES

- 2-channel stepping motor driver
A signal driver controls 2 stepping motors
- Built-in decoder for micro steps (2-phase, half step, 1-2 phase, W1-2 phase and 2W1-2 phase excitation)
Stepping motor can be driven by only external clock signal.
- PWM can be driven by built-in CR (3-value can be selected during PWM OFF period.)
The selection of PWM OFF period enables the best PWM drive.
- Mix Decay control (4-value can be selected for Fast Decay ratio)
Mix Decay control can improve accuracy of motor current waveform.
- Built-in over-current protection (OCP)
If the current flows to motor output more than the setup value due to ground-fault etc., the OCP operates and all motor outputs are turned OFF.
- Built-in under voltage lockout (UVLO)
If supply voltage falls to less than the operating supply voltage range, the UVLO operates and all motor outputs are turned OFF.

APPLICATIONS

- LSI for stepping motor drives

- Built-in thermal protection (TSD)
If chip junction temperature rises and reaches to the setup temperature, all motor outputs are turned OFF.
- Built-in abnormal detection output function
If OCP or TSD operates, an abnormal detection signal is output.
- Built-in standby function
The operation of standby function can lower current consumption of this LSI.
- Built-in Home Position function
Home Position function can detect the position of motor.
- Built-in step detection output function
If step detection output function detects clock input signal, it outputs a signal.
- Built-in 5 V power supply (accuracy : ±5%)
- 56 pin Plastic Small Outline Package With Heat Sink (SOP Type)

DESCRIPTION

AN44071A is a quad channel H-bridge driver LSI. Two bipolar stepping motor can be controlled by a single driver LSI. Interface control is 1CLK_type, it can be selected 2-phase excitation, half- step, 1-2 phase excitation, W1-2 phase excitation and 2W1-2 phase excitation.

SIMPLIFIED APPLICATION

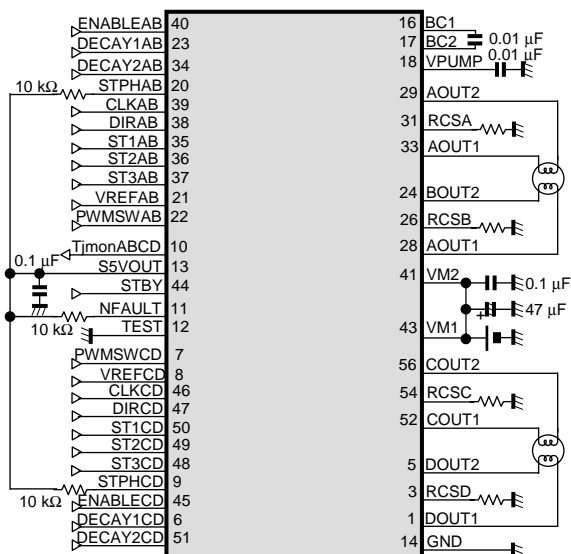

Notes)

This application circuit is an example. The operation of mass production set is not guaranteed. You should perform enough evaluation and verification on the design of mass production set. You are fully responsible for the incorporation of the above application circuit and information in the design of your equipment.

Mix Decay effect for Motor current

【Fig1:Slow Decay】

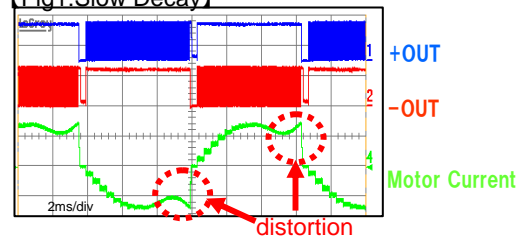

【Fig2:Mix Decay(25%)】

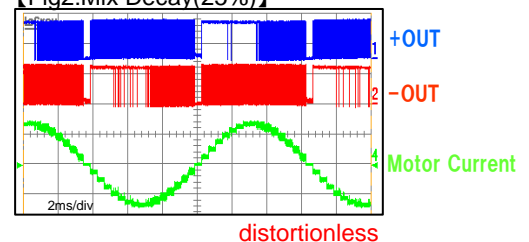

Condition:

excitation mode :2W1-2 phase drive
fig1 DECAY1=L DECAY2=L
fig2 DECAY1=L DECAY2=H

ABSOLUTE MAXIMUM RATINGS

Parameter	Symbol	Rating	Unit	Note
Supply voltage (Pin 41, 43)	V_M	37	V	*1
Power dissipation	P_D	448	mW	*2
Operating ambient temperature	T_{opr}	-20 to +85	°C	*3
Operating junction temperature	T_j	-20 to +150	°C	*3
Storage temperature	T_{stg}	-55 to +150	°C	*3
Output pin voltage (Pin 1, 5, 24, 28, 29, 33, 52, 56)	V_{OUT}	37	V	*4
Motor drive current 1 (Pin 24, 28, 29, 33)	I_{OUT1}	±1.0	A	*5
Motor drive current 2 (Pin 1, 5, 52, 56)	I_{OUT2}	±1.7	A	*5
Flywheel diode current 1 (Pin 24, 28, 29, 33)	I_{f1}	±1.0	A	*5
Flywheel diode current 2 (Pin 1, 5, 52, 56)	I_{f2}	±1.7	A	*5
Input Voltage Range	$V_{RCSA}, V_{RCSB}, V_{RCSC}, V_{RCSD};$	2.5	V	—
	$V_{DECAY2CD}, V_{DECAY2AB}$ $V_{DECAY1CD}, V_{DECAY1AB}$	-0.3 to 6	V	—
	$V_{PWMSWAB}, V_{PWMSWCD}$	-0.3 to 6	V	—
	V_{VREFAB}, V_{VREFCD}	-0.3 to 6	V	—
	V_{STPHAB}, V_{STPHCD}	-0.3 to 6	V	*6
	V_{NFAULT}	-0.3 to 6	V	*6
	V_{TEST}	-0.3 to 6	V	—
	V_{BC2}	(VM-1) to 43	V	*7
	V_{VPUMP}	(VM-2) to 43	V	*7
	$V_{ST1AB}, V_{ST2AB}, V_{ST3AB}$ $V_{ST1CD}, V_{ST2CD}, V_{ST3CD}$	-0.3 to 6	V	—
	V_{DIRAB}, V_{DIRCD}	-0.3 to 6	V	—
	V_{CLKAB}, V_{CLKCD}	-0.3 to 6	V	—
	$V_{ENABLEAB}, V_{ENABLECD}$	-0.3 to 6	V	—
	V_{STBY}	-0.3 to 6	V	—
	I_{STPHAB}, I_{STPHCD}	2	mA	*6
	I_{NFAULT}	2	mA	*6
	I_{S5VOUT}	-7 to 0	mA	—
	ESD	HBM (Human Body Model)	±2	kV
CDM (Charge Device Model)		±1	kV	—

Notes). This product may sustain permanent damage if subjected to conditions higher than the above stated absolute maximum rating. This rating is the maximum rating and device operating at this range is not guaranteeable as it is higher than our stated recommended operating range.

When subjected under the absolute maximum rating for a long time, the reliability of the product may be affected.

*1 : The values under the condition not exceeding the above absolute maximum ratings and the power dissipation.

*2 : The power dissipation shown is the value at $T_a = 85^\circ\text{C}$ for the independent (unmounted) LSI package without a heat sink.

When using this LSI, refer to the P_D - T_a diagram of the package standard and design the heat radiation with sufficient margin so that the allowable value might not be exceeded based on the conditions of power supply voltage, load, and ambient temperature.

*3 : Except for the power dissipation, operating ambient temperature, and storage temperature, all ratings are for $T_a = 25^\circ\text{C}$.

ABSOLUTE MAXIMUM RATINGS (continued)

- Notes) *4 :This is a rated value of output voltage, and do not apply input voltage from outside to these pins. Set not to exceed the allowable range at any time.
- *5 :Do not apply external current to any pin specially mentioned. For circuit currents, (+) denotes current flowing into the LSI and (–) denotes current flowing out of the LSI.
- *6 :This pin is connected to open drain circuit inside. Connect a resistor in series with power supply.Do not exceed the rated value at any time. Refer to page 4 for the recommended value.
- *7 :External voltage must not be applied to this pin. Do not exceed the rated value at any time.

POWER DISSIPATION RATING

Condition	θ_{JA}	PD (Ta=25 °C)	PD (Ta=85 °C)
Mount on PWB *1	79.5 °C/W	1572mW	818mW
Without PWB	144.9°C/W	863mW	448mW

Note). For the actual usage, please refer to the PD-Ta characteristics diagram in the package specification, supply voltage, load and ambient temperature conditions to ensure that there is enough margin follow the power and the thermal design does not exceed the allowable value.

*1: Glass-Epoxy: 50×50×0.8 (mm) , heat dissipation fin: Dai-pad , the state where it does not mount.



CAUTION

Although this has limited built-in ESD protection circuit, but permanent damage may occur on it. Therefore, proper ESD precautions are recommended to avoid electrostatic damage to the MOS gates

RECOMMENDED OPERATING CONDITIONS

Parameter	Symbol	Min.	Typ.	Max.	Unit	Note
Supply voltage range	VM1, VM2	10	24	34	V	*1
Input Voltage Range	$V_{DECAY2CD}, V_{DECAY2AB}$ $V_{DECAY1CD}, V_{DECAY1AB}$	0	-	5.5	V	—
	$V_{PWMSWAB}, V_{PWMSWCD}$	0	-	5.5	V	—
	V_{VREFAB}, V_{VREFCD}	0	-	5	V	—
	V_{TEST}	0	-	5.5	V	—
	$V_{ST1AB}, V_{ST2AB}, V_{ST3AB}$ $V_{ST1CD}, V_{ST2CD}, V_{ST3CD}$	0	-	5.5	V	—
	V_{DIRAB}, V_{DIRCD}	0	-	5.5	V	—
	V_{CLKAB}, V_{CLKCD}	0	-	5.5	V	—
	$V_{ENABLEAB}, V_{ENABLECD}$	0	-	5.5	V	—
	V_{STBY}	0	-	5.5	V	—
External Constants	C_{BC}	-	0.01	-	μF	—
	C_{VPUMP}	-	0.01	-	μF	—
	C_{SSVOUT}	-	0.1	-	μF	—
Operating ambient temperature	Ta ^{opr}	-20	-	85	°C	—
Operating junction temperature	Tj ^{opr}	-	-	120	°C	—

Note) *1 : The values under the condition not exceeding the above absolute maximum ratings and the power dissipation.

ELECTRICAL CHARACTERISTICS

VM=24V, Ta = 25°C±2°C unless otherwise specified.

Parameter	Symbol	Condition	Limits			Unit	Note
			Min	Typ	Max		
Power block							
Output saturation voltage 1 High	V _{OH1}	I = -0.5 A (Pin 24, 28, 29, 33)	VM - 0.5	VM - 0.3	—	V	—
Output saturation voltage 1 Low	V _{OL1}	I = 0.5 A (Pin 24, 28, 29, 33)	—	0.48	0.75	V	—
Output saturation voltage 2 High	V _{OH2}	I = -0.8 A (Pin 1, 5, 52, 56)	VM - 0.55	VM - 0.35	—	V	—
Output saturation voltage 2 Low	V _{OL2}	I = 0.8 A (Pin 1, 5, 52, 56)	—	0.64	0.97	V	—
Flywheel diode forward voltage 1	V _{DI1}	I = 0.5 A (Pin 24, 28, 29, 33)	0.5	1	1.5	V	—
Flywheel diode forward voltage 2	V _{DI2}	I = 0.8 A (Pin 1, 5, 52, 56)	0.5	1	1.5	V	—
Upper-side output OFF current	I _{OUTOFF1}	V _M = 37 V, V _{RCS} = 0 V, OUT = 0 V	-10	—	—	μA	*1
Lower-side output OFF current	I _{OUTOFF2}	V _M = 37 V, V _{RCS} = 0 V, OUT = 37 V	—	—	100	μA	*1
Supply current							
Supply current (Active)	I _M	ENABLEAB = ENABLECD = Low, STBY = High	—	10	19	mA	—
Supply current (STBY)	I _{MSTBY}	STBY = Low	—	22	40	μA	—
I/O Block							
STBY High-level input voltage	V _{STBYH}	—	2.1	—	5.5	V	—
STBY Low-level input voltage	V _{STBYL}	—	0	—	0.6	V	—
STBY High-level input current	I _{STBYH}	STBY = 5 V	25	50	100	μA	—
STBY Low-level input current	I _{STBYL}	STBY = 0 V	-2	—	2	μA	—
CLK High-level input voltage	V _{CLKH}	—	2.1	—	5.5	V	*2
CLK Low-level input voltage	V _{CLKL}	—	0	—	0.6	V	*2
CLK High-level input current	I _{CLKH}	CLK = 5 V	25	50	100	μA	*2
CLK Low-level input current	I _{CLKL}	CLK = 0 V	-2	—	2	μA	*2
CLK maximum input frequency	f _{CLK}	—	50	—	—	kHz	*2
ENABLE High-level input voltage	V _{ENABLEH}	—	2.1	—	5.5	V	*3
ENABLE Low-level input voltage	V _{ENABLEL}	—	0	—	0.6	V	*3
ENABLE High-level input current	I _{ENABLEH}	ENABLE = 5 V	25	50	100	μA	*3
ENABLE Low-level input current	I _{ENABLEL}	ENABLE = 0 V	-2	—	2	μA	*3

Notes) *1 :OUT represents AOUT1, AOUT2, BOUT1, BOUT2, COUT1, COUT2, DOUT1 and DOUT2.

*2 :CLK represents CLKAB and CLKCD.

*3 :ENABLE represents ENABLEAB and ENABLECD.

ELECTRICAL CHARACTERISTICS (continued)

VM=24V, T_a = 25°C±2°C unless otherwise noted.

Parameter	Symbol	Condition	Limits			Unit	Note
			Min	Typ	Max		
I/O Block (Continued)							
PWMSW High-level input voltage	V _{PWMSWH}	—	2.3	—	5.5	V	*4
PWMSW Middle-level input voltage	V _{PWMSWM}	—	1.3	—	1.7	V	*4
PWMSW Low-level input voltage	V _{PWMSWL}	—	0	—	0.6	V	*4
PWMSW High-level input current	I _{PWMSWH}	PWMSW = 5 V	40	83	150	μA	*4
PWMSW Low-level input current	I _{PWMSWL}	PWMSW = 0 V	-70	-36	-18	μA	*4
PWMSW open voltage	V _{PWMSWO}	—	1.3	1.5	1.7	V	*4
DECAY High-level input voltage	V _{DECAYH}	—	2.1	—	5.5	V	*5
DECAY Low-level input voltage	V _{DECAYL}	—	0	—	0.6	V	*5
DECAY High-level input current	I _{DECAYH}	DECAY = 5 V	25	50	100	μA	*5
DECAY Low-level input current	I _{DECAYL}	DECAY = 0 V	-2	—	2	μA	*5
DIR High-level input voltage	V _{DIRH}	—	2.1	—	5.5	V	*6
DIR Low-level input voltage	V _{DIRL}	—	0	—	0.6	V	*6
DIR High-level input current	I _{DIRH}	DIR = 5 V	25	50	100	μA	*6
DIR Low-level input current	I _{DIRL}	DIR = 0 V	-2	—	2	μA	*6
ST High-level input voltage	V _{STH}	—	2.1	—	5.5	V	*7
ST Low-level input voltage	V _{STL}	—	0	—	0.6	V	*7
ST High-level input current	I _{STH}	ST = 5 V	25	50	100	μA	*7
ST Low-level input current	I _{STL}	ST = 0 V	-2	—	2	μA	*7
Torque Control Block							
Input bias current 1	I _{REFH}	V _{REFAB} = V _{REFCD} = 5 V	-2	—	2	μA	—
Input bias current 2	I _{REFL}	V _{REFAB} = V _{REFCD} = 0 V	-2	—	2	μA	—
PWM OFF time 1	T _{OFF1}	PWMSW = Low	16.8	28	39.2	μs	*4
PWM OFF time 2	T _{OFF2}	PWMSW = High	9.1	15.2	21.3	μs	*4
PWM OFF time 3	T _{OFF3}	PWMSW = Middle	4.9	8.1	11.3	μs	*4
Pulse blanking time	T _B	V _{REFAB} = V _{REFCD} = 0 V	0.4	0.7	1.0	μs	—
Comp threshold	V _{T_{CMP}}	V _{REFAB} = V _{REFCD} = 5 V	475	500	525	mV	—
Reference voltage block							
Reference voltage	V _{S5VOUT}	I _{S5VOUT} = 0 mA	4.75	5.0	5.25	V	—
Output impedance	Z _{S5VOUT}	I _{S5VOUT} = -7 mA	—	—	10	Ω	—

Notes) *4 : PWMSW represents PWMSWAB and PWMSWCD.
 *5 : DECAY represents DECAY1AB, DECAY2AB, DECAY1CD and DECAY2CD.
 *6 : DIR represents DIRAB and DIRCD.
 *7 : ST represents ST1AB, ST2AB, ST3AB, ST1CD, ST2CD and ST3CD.

ELECTRICAL CHARACTERISTICS (continued)

VM=24V, T_a = 25°C±2°C unless otherwise noted.

Parameter	Symbol	Condition	Limits			Unit	Note
			Min	Typ	Max		
Abnormal detection output block							
NFAULT pin output Low-level voltage	V _{NFAULTL}	I _{NFAULT} = 1 mA	—	—	0.2	V	—
NFAULT pin output leak current	I _{NFAULT(leak)}	V _{NFAULT} = 5 V	—	—	5	μA	—
Home Position/ STEP detection output block							
STPH pin output Low-level voltage	V _{STPHL}	I _{STPH} = 1 mA	—	—	0.2	V	*8
STPH pin output leak current	I _{STPH(leak)}	V _{STPH} = 5 V	—	—	5	μA	*8
Test input block							
TEST High-level input voltage	V _{TESTH}	—	4.0	—	5.5	V	—
TEST Low-level input voltage	V _{TESTL}	—	0	—	0.6	V	—
TEST High-level input current	I _{TESTH}	TEST = 5 V	25	50	100	μA	—
TEST High-level input current	I _{TESTL}	TEST = 0 V	-2	—	2	μA	—

*8 : STPH represents STPHAB and STPHCD.

ELECTRICAL CHARACTERISTICS (continued)

VM=24V, T_a = 25°C±2°C unless otherwise noted.

Parameter	Symbol	Condition	Limits			Unit	Note
			Min	Typ	Max		
Output block							
Output slew rate 1	VT _r	At the rising edge of output voltage, sink side of motor current	—	350	—	V/μs	*9 *10
Output slew rate 2	VT _f	At the falling edge of output voltage, sink side of motor current	—	-400	—	V/μs	*9 *10
Dead time	T _D	—	—	0.8	—	μs	*9 *10
Thermal shutdown protection							
Thermal shutdown protection operating temperature	TSD _{on}	—	—	150	—	°C	*10
Under voltage lockout							
Protection start voltage	V _{UVLO1}	—	—	7.5	—	V	*10
Protection stop voltage	V _{UVLO2}	—	—	8.5	—	V	*10

*9 :The characteristics of all outputs of AOUT1, AOUT2, BOUT1, BOUT2, COUT1, COUT2, DOUT1 and DOUT2 are shown.

*10 :Typical Value checked by design.

PIN CONFIGURATION

Top View

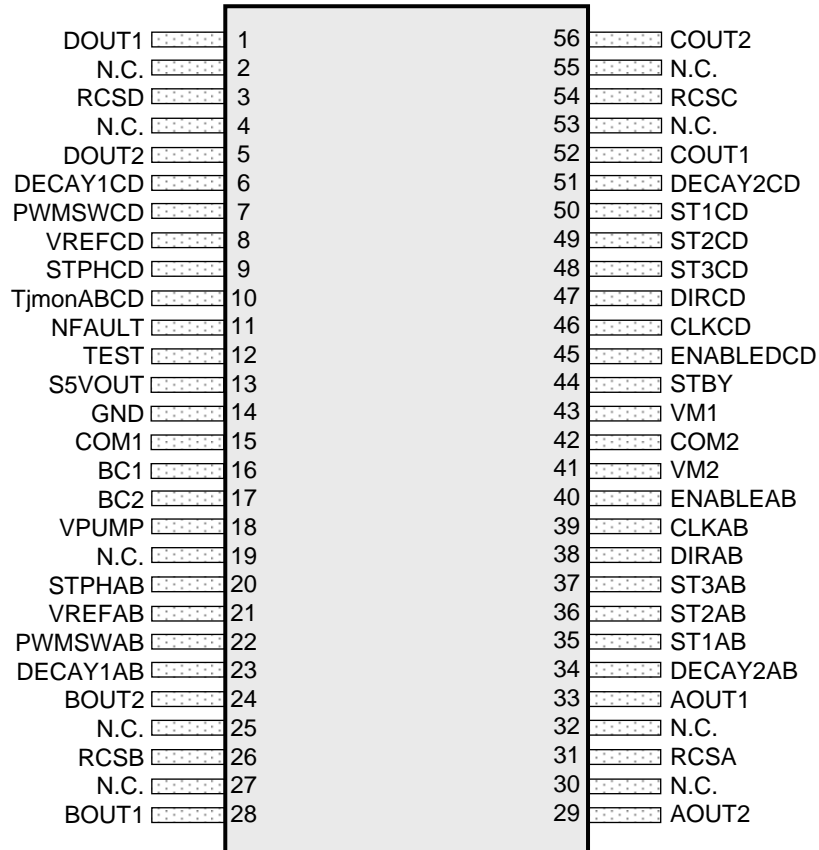

PIN FUNCTIONS

Pin No.	Pin name	Type	Description
1	DOUT1	Output	Phase D motor drive output 1
2, 4, 19, 25, 27, 30, 32, 53, 55	N.C.	—	N.C.
3	RCS D	Input/Output	Phase D motor current detection
5	DOUT2	Output	Phase D motor drive output 2
6	DECAY1CD	Input	Phase C/D Mix Decay setup 1
7	PWMSWCD	Input	Phase C/D PWM OFF period selection input
8	VREFCD	Input	Phase C/D Torque reference voltage input
9	STPHCD	Output	Phase C/D Home Position / Step detection signal output
10	TjmonABCD	Output	Phase A/B, C/D VBE monitor
11	NFAULT	Output	Abnormal detection output
12	TEST	Input	Test mode setup
13	S5VOUT	Output	Internal reference voltage (output 5 V)
14	GND	Ground	Ground
15	COM1	—	Die pad ground 1
16	BC1	Output	Capacitor connection 1 for charge pump
17	BC2	Output	Capacitor connection 2 for charge pump
18	VPUMP	Output	Charge pump circuit output
20	STPHAB	Output	Phase A/B Home Position / Step detection signal output
21	VREFAB	Input	Phase A/B Torque reference voltage input
22	PWMSWAB	Input	Phase A/B PWM OFF period selection input
23	DECAY1AB	Input	Phase A/B Mix Decay setup 1
24	BOUT2	Output	Phase B motor drive output 2
26	RCSB	Input/Output	Phase B motor current detection
28	BOUT1	Output	Phase B motor drive output 1

PIN FUNCTIONS (continued)

Pin No.	Pin name	Type	Description
29	AOUT2	Output	Phase A motor drive output 2
31	RCSA	Input/Output	Phase A motor current detection
33	AOUT1	Output	Phase A motor drive output 1
34	DECAY2AB	Input	Phase A/B Mix Decay setup 2
35	ST1AB	Input	Phase A/B excitation selection 1
36	ST2AB	Input	Phase A/B excitation selection 2
37	ST3AB	Input	Phase A/B excitation selection 3
38	DIRAB	Input	Phase A/B rotation direction setup
39	CLKAB	Input	Phase A/B clock input
40	ENABLEAB	Input	Phase A/B Enable / disable CTL
41	VM2	Power supply	Power supply 2 for motor
42	COM2	—	Die pad ground 2
43	VM1	Power supply	Power supply 1 for motor
44	STBY	Input	Standby
45	ENABLECD	Input	Phase C/D Enable / disable CTL
46	CLKCD	Input	Phase C/D clock input
47	DIRCD	Input	Phase C/D rotation direction setup
48	ST3CD	Input	Phase C/D excitation selection 3
49	ST2CD	Input	Phase C/D excitation selection 2
50	ST1CD	Input	Phase C/D excitation selection 1
51	DECAY2CD	Input	Phase C/D Mix Decay setup 2
52	COUT1	Output	Phase C motor drive output 1
54	RCSC	Input/Output	Phase C motor current detection
56	COUT2	Output	Phase C motor drive output 2

Notes) Concerning detail about pin description, please refer to OPERATION and APPLICATION INFORMATION section.

FUNCTIONAL BLOCK DIAGRAM

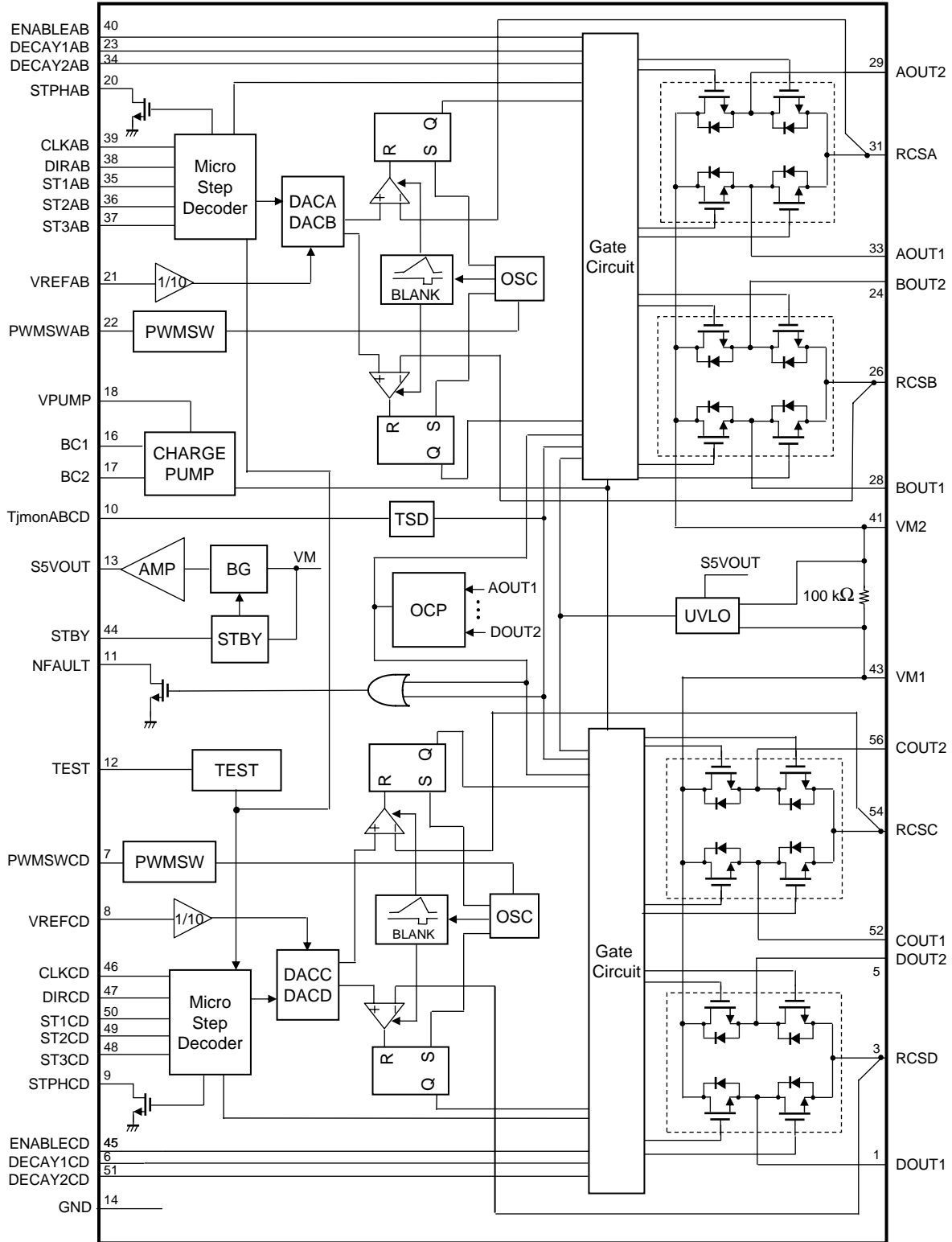

Note) This block diagram is for explaining functions. Part of the block diagram may be omitted, or it may be simplified.

OPERATION

1. Control mode

Note)* is AB or CD.

1) Truth table (Excitation select)

ENABLE*	DIR*	ST1*	ST2*	ST3*	Output excitation mode	
Low	—	—	—	—	—	Output OFF
High	Low	Low	Low	Low	Phase B/D 90° delay to phase A/C	2-phase excitation drive (4-step sequence)
High	Low	Low	High	Low		Half step drive (8-step sequence)
High	Low	High	Low	Low		1-2 phase excitation drive (8-step sequence)
High	Low	High	High	Low		W1-2 phase excitation drive (16-step sequence)
High	Low	—	—	High		2W1-2 phase excitation drive (32-step sequence)
High	High	Low	Low	Low	Phase B/D 90° advance to phase A/C	2-phase excitation drive (4-step sequence)
High	High	Low	High	Low		Half step drive (8-step sequence)
High	High	High	Low	Low		1-2 phase excitation drive (8-step sequence)
High	High	High	High	Low		W1-2 phase excitation drive (16-step sequence)
High	High	—	—	High		2W1-2 phase excitation drive (32-step sequence)

2) Truth table (Control / Charge pump circuit)

STBY	ENABLE*	Control / Charge pump circuit	Output transistor
Low	—	OFF	All channel output : OFF
High (*3)	Low	ON	OFF (*4)
High (*3)	High	ON	ON

3) Truth table (PWM OFF period selection)

PWMSW*	PWM OFF period (*5)
Low	28.0 μ s
Middle	8.1 μ s
High	15.2 μ s

4) Truth table (Decay selection)

DECAY1*	DECAY2*	Decay control (*6)
Low	Low	Slow Decay
Low	High	25%
High	Low	50%
High	High	100%

5) Truth table (STPH output selection)

TEST	STPH* output
Low	STEP detection output
High	Home Position output

Note) The above rate is applied to Fast Decay every PWM OFF period.

6) Truth table (NFAULT output)

TSD (*1)	OCP (*2)	NFAULT	Output transistor
Thermal shutdown protection start	—	Low	All channel output : OFF
—	Over-current detection start	Low	All channel output : OFF
Thermal shutdown protection stop	Over-current detection stop	Hi-Z	ON

Notes) *1 : TSD is a latch type protection

→ The protection operation starts at 150°C. (All motor outputs are turned off , and latched.) / The latch is released by Standby or UVLO.

*2 : OCP is a latch type protection

→ All motor outputs are turned off by over-current detection, and be latched. / The latch is released by Standby or UVLO. In addition, All motor outputs are turned off at under UVLO.

*3 : Input external signals to STBY pin in order to set STBY signal to High-level.

Because, STBY pin cannot be set to High-level when it is connected to S5VOUT(Pin13).

*4 : The output transistors of AB/CD channel are controlled by ENABLEAB/CD respectively.

*5 : The PWM OFF intervals of AB/CD channel are set by PWMSWAB/CD respectively.

*6 : The Decay controls of AB/CD channel are set by DECAY1AB/CD (DECAY2AB/CD) respectively.

OPERATION (continued)

2. Each phase current value

1) 1-2 phase, W1-2 phase, 2W1-2 phase DIRAB / DIRCD = Low

Note) The definition of Phase A, B, C and D current "100%" : $(VREFAB(VREFCD) \times 0.1) / \text{Motor current detection resistance}$

1-2 phase (8-Step)	W1-2 phase (16- Step)	2W1-2 phase (32-Step)	A/C phase current (%)	B/D phase current (%)
1	1	1	70.7	-70.7
—	—	2	83.2	-55.6
—	2	3	92.4	-38.3
—	—	4	98.1	-19.5
2	3	5	100	0
—	—	6	98.1	19.5
—	4	7	92.4	38.3
—	—	8	83.2	55.6
3	5	9	70.7	70.7
—	—	10	55.6	83.2
—	6	11	38.3	92.4
—	—	12	19.5	98.1
4	7	13	0	100
—	—	14	-19.5	98.1
—	8	15	-38.3	92.4
—	—	16	-55.6	83.2
5	9	17	-70.7	70.7
—	—	18	-83.2	55.6
—	10	19	-92.4	38.3
—	—	20	-98.1	19.5
6	11	21	-100	0
—	—	22	-98.1	-19.5
—	12	23	-92.4	-38.3
—	—	24	-83.2	-55.6
7	13	25	-70.7	-70.7
—	—	26	-55.6	-83.2
—	14	27	-38.3	-92.4
—	—	28	-19.5	-98.1
8	15	29	0	-100
—	—	30	19.5	-98.1
—	16	31	38.3	-92.4
—	—	32	55.6	-83.2

OPERATION (continued)

2. Each phase current value (continued)

2) 1-2 phase, W1-2 phase, 2W1-2 phase DIRAB / DIRCD = High

Note) The definition of Phase A, B, C and D current "100%" : $(VREFAB(VREFCD) \times 0.1) / \text{Motor current detection resistance}$

1-2 phase (8-Step)	W1-2 phase (16-Step)	2W1-2 phase (32-Step)	A/C phase current (%)	B/D phase current (%)
1	1	1	70.7	-70.7
—	—	2	55.6	-83.2
—	2	3	38.3	-92.4
—	—	4	19.5	-98.1
2	3	5	0	-100
—	—	6	-19.5	-98.1
—	4	7	-38.3	-92.4
—	—	8	-55.6	-83.2
3	5	9	-70.7	-70.7
—	—	10	-83.2	-55.6
—	6	11	-92.4	-38.3
—	—	12	-98.1	-19.5
4	7	13	-100	0
—	—	14	-98.1	19.5
—	8	15	-92.4	38.3
—	—	16	-83.2	55.6
5	9	17	-70.7	70.7
—	—	18	-55.6	83.2
—	10	19	-38.3	92.4
—	—	20	-19.5	98.1
6	11	21	0	100
—	—	22	19.5	98.1
—	12	23	38.3	92.4
—	—	24	55.6	83.2
7	13	25	70.7	70.7
—	—	26	83.2	55.6
—	14	27	92.4	38.3
—	—	28	98.1	19.5
8	15	29	100	0
—	—	30	98.1	-19.5
—	16	31	92.4	-38.3
—	—	32	83.2	-55.6

OPERATION (continued)

3. Each phase current value(Timing chart)

1) 2-phase excitation drive (4-step sequence)

(ST1AB/ST1CD = Low, ST2AB/ST2CD = Low, ST3AB/ST3CD = Low)

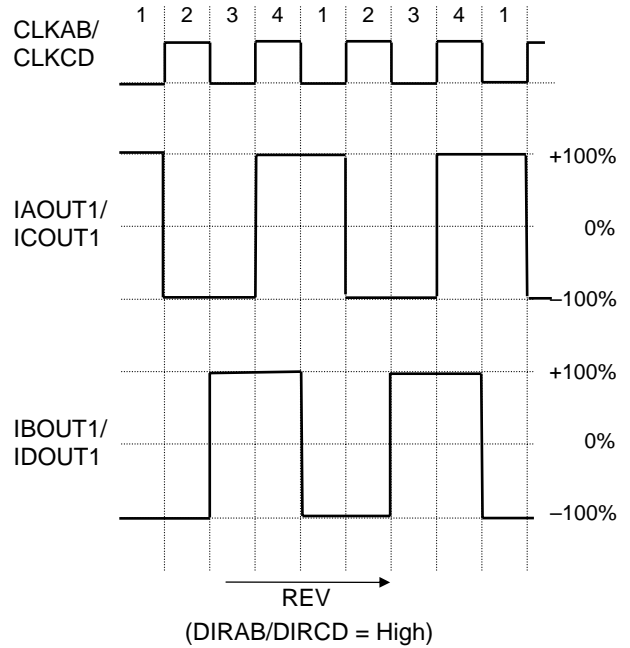
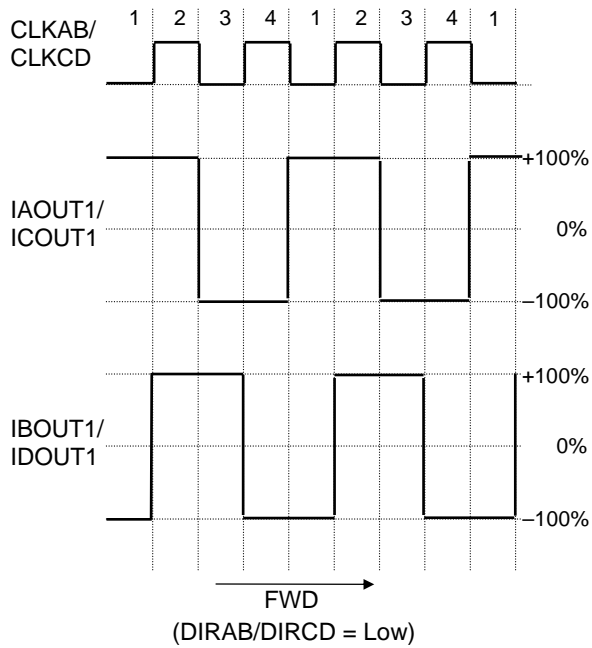

2) Half step drive (8-step sequence)

(ST1AB/ST1CD = Low, ST2AB/ST2CD = High, ST3AB/ST3CD = Low)

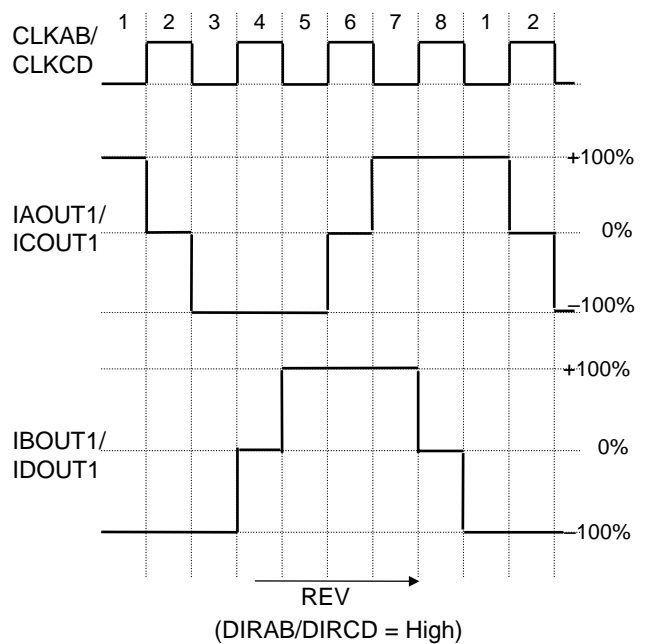
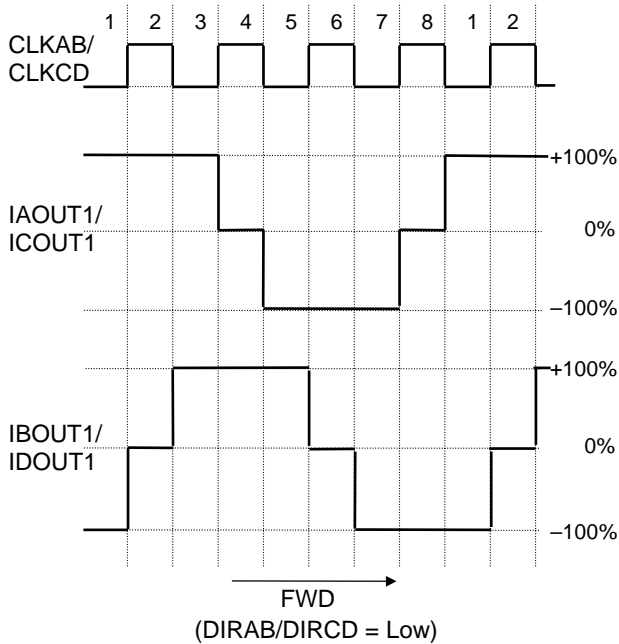

OPERATION (continued)

3. Each phase current value (Timing chart) (continued)

- 3) 1-2-phase excitation (8-step sequence)
 (ST1AB/ST1CD = High, ST2AB/ST2CD = Low, ST3AB/ST3CD = Low)

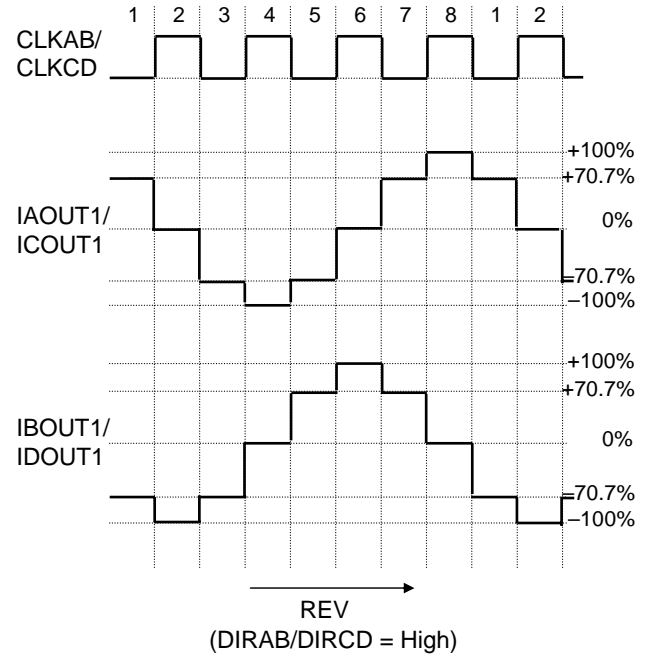
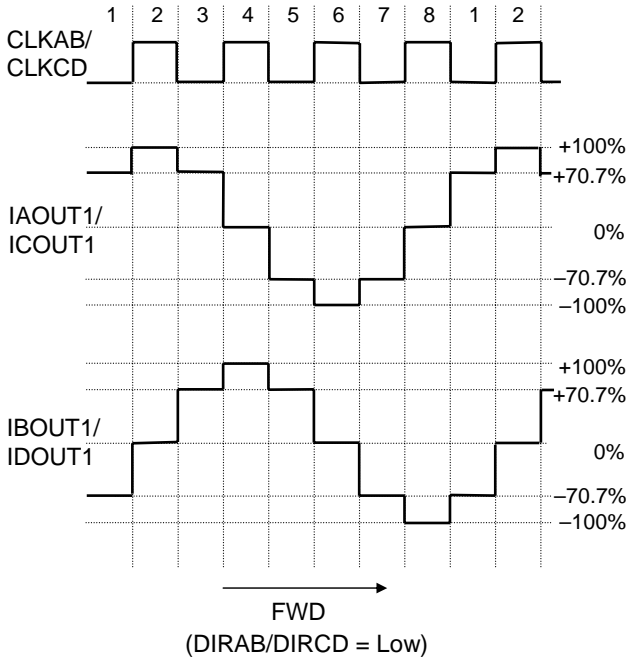

OPERATION (continued)

3. Each phase current value (Timing chart) (continued)

- 4) W1-2-phase excitation (16-step sequence)
 (ST1AB/ST1CD = High, ST2AB/ST2CD = High, ST3AB/ST3CD = Low)

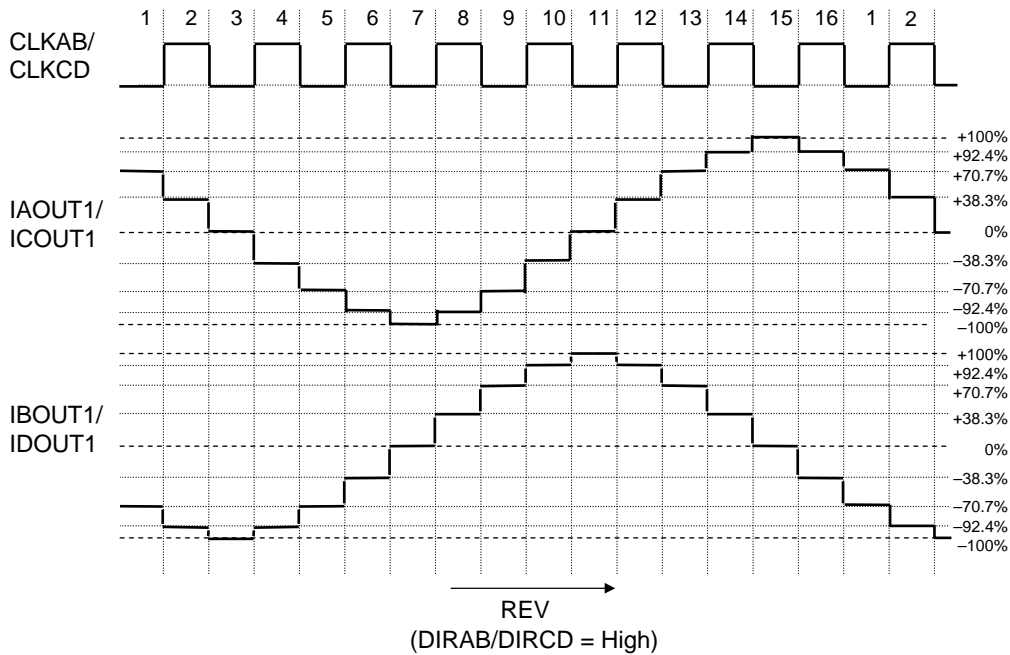
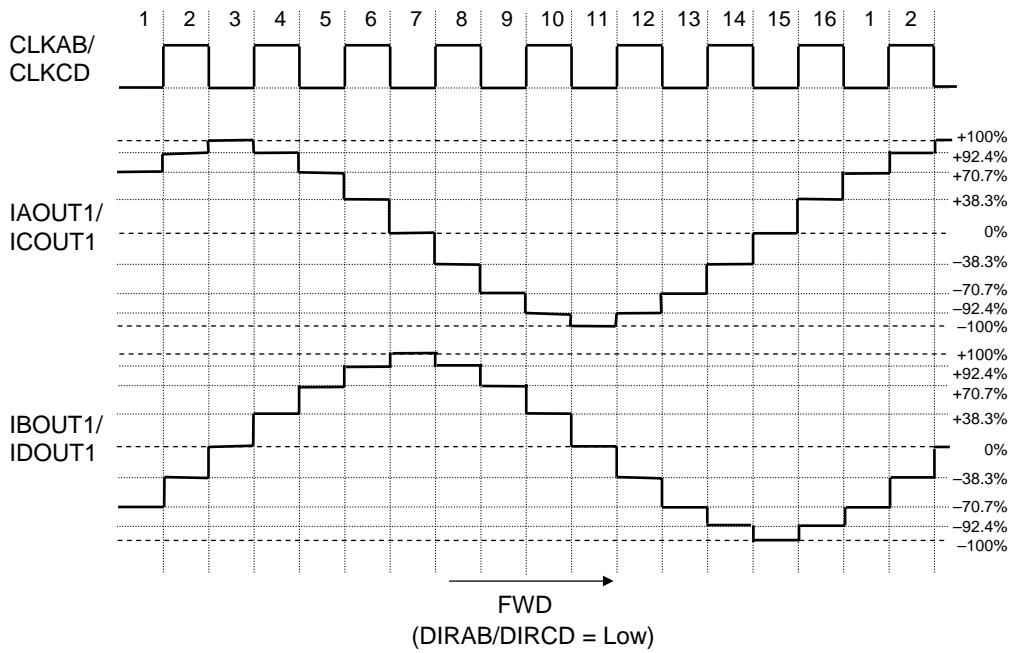

OPERATION (continued)

3. Each phase current value (Timing chart) (continued)

5) 2W1-2-phase excitation (32-step sequence)
(ST3AB/ST3CD = High)

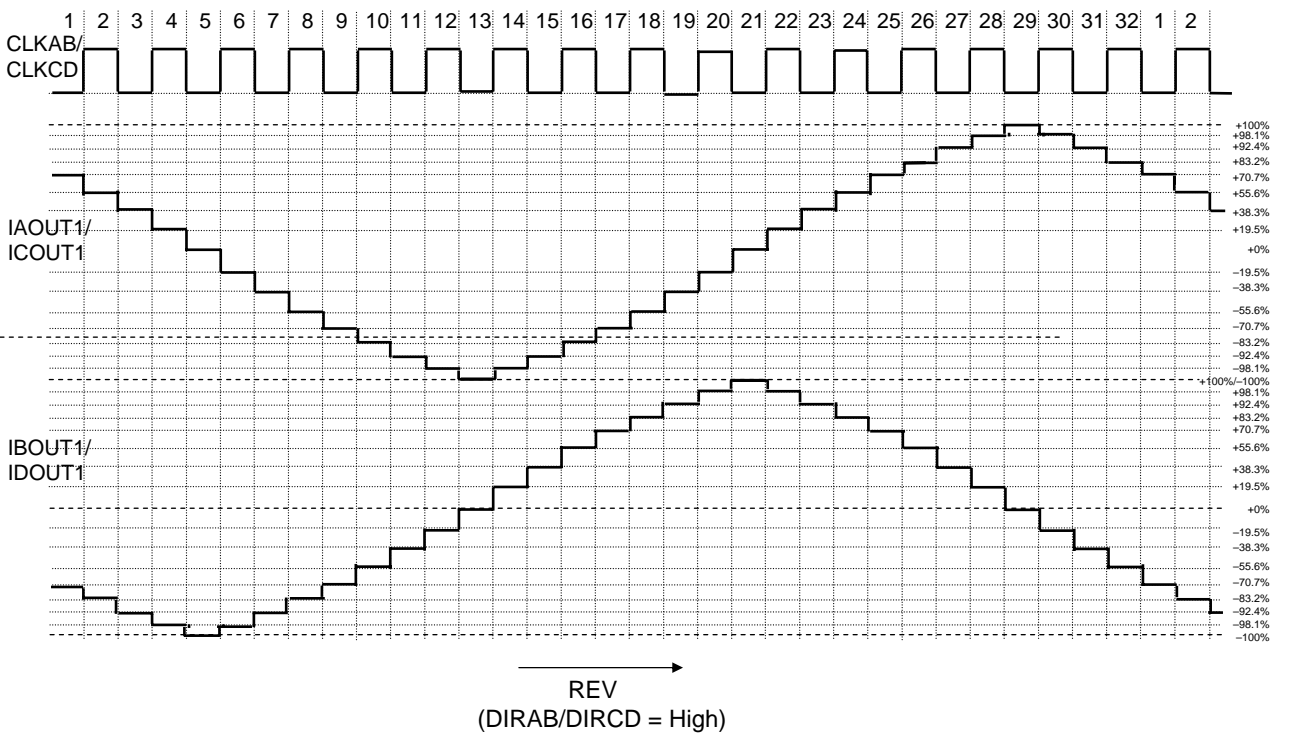
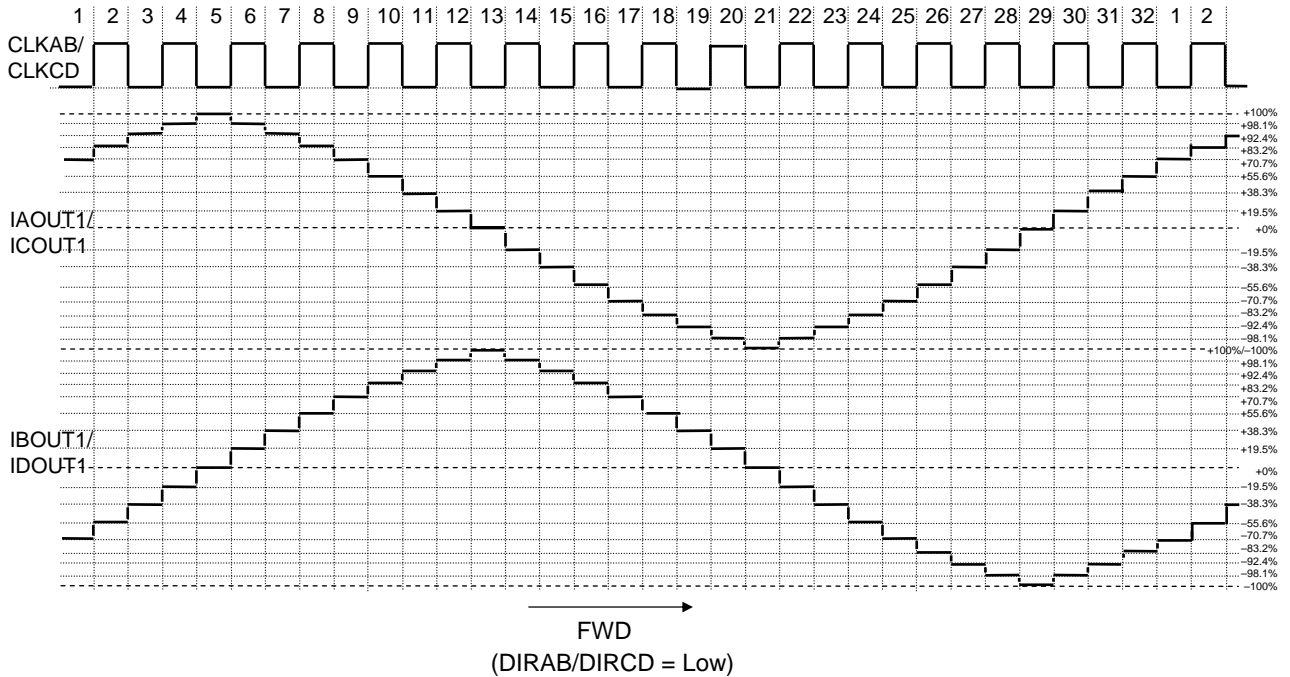

OPERATION (continued)

4. Timing chart when DIR switches

(Example 1) Timing chart at 1-2-phase excitation (DIRAB/DIRCD : Low → High)

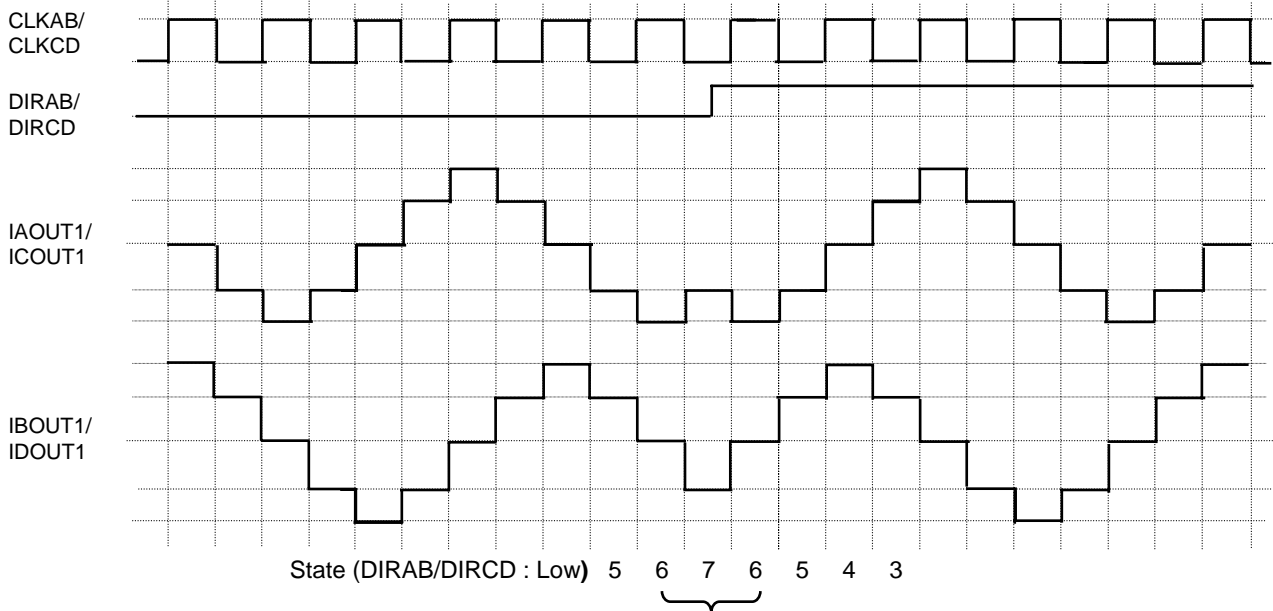

When DIRAB(DIRCD) switches, the state before switching is kept and operates continuously.

(Example 2) Timing chart at 1-2-phase excitation (DIRAB/DIRCD : High → Low)

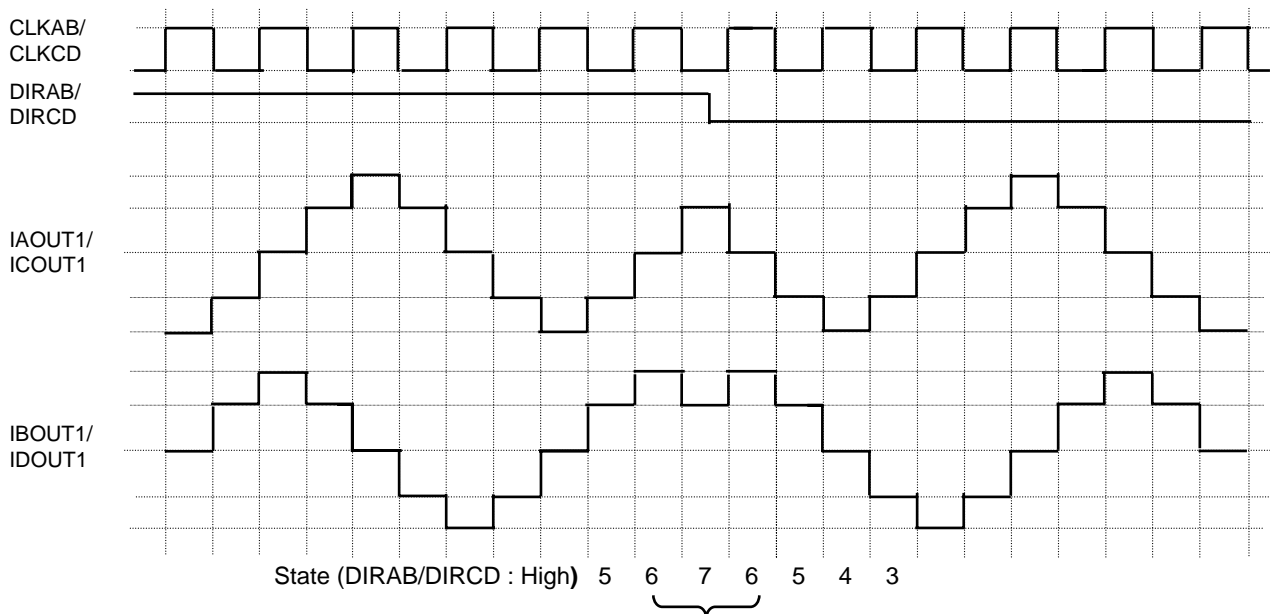

When DIRAB(DIRCD) switches, the state before switching is kept and operates continuously.

OPERATION (continued)

5. Home Position function (TEST=High)

This LSI has built-in Home Position function to reduce the displacement of motor current state at the change of excitation mode during motor drive. Low-level voltage is output to STPHAB pin and STPHCD pin at the timing when the displacement of motor current state doesn't occur at the change of excitation mode. The timing when Low-level voltage is output to STPHAB pin and STPHCD pin is as follows. The Home Position function becomes valid by setting TEST pin to High.

Connect pull-up resistor to power supply (recommendation : S5VOUT), because STPHAB pin and STPHCD pin are composed by open drain circuit. The recommended value of pull-up resistor is 10 kΩ.

Home Position output timing chart (DIRAB / DIRCD = Low)

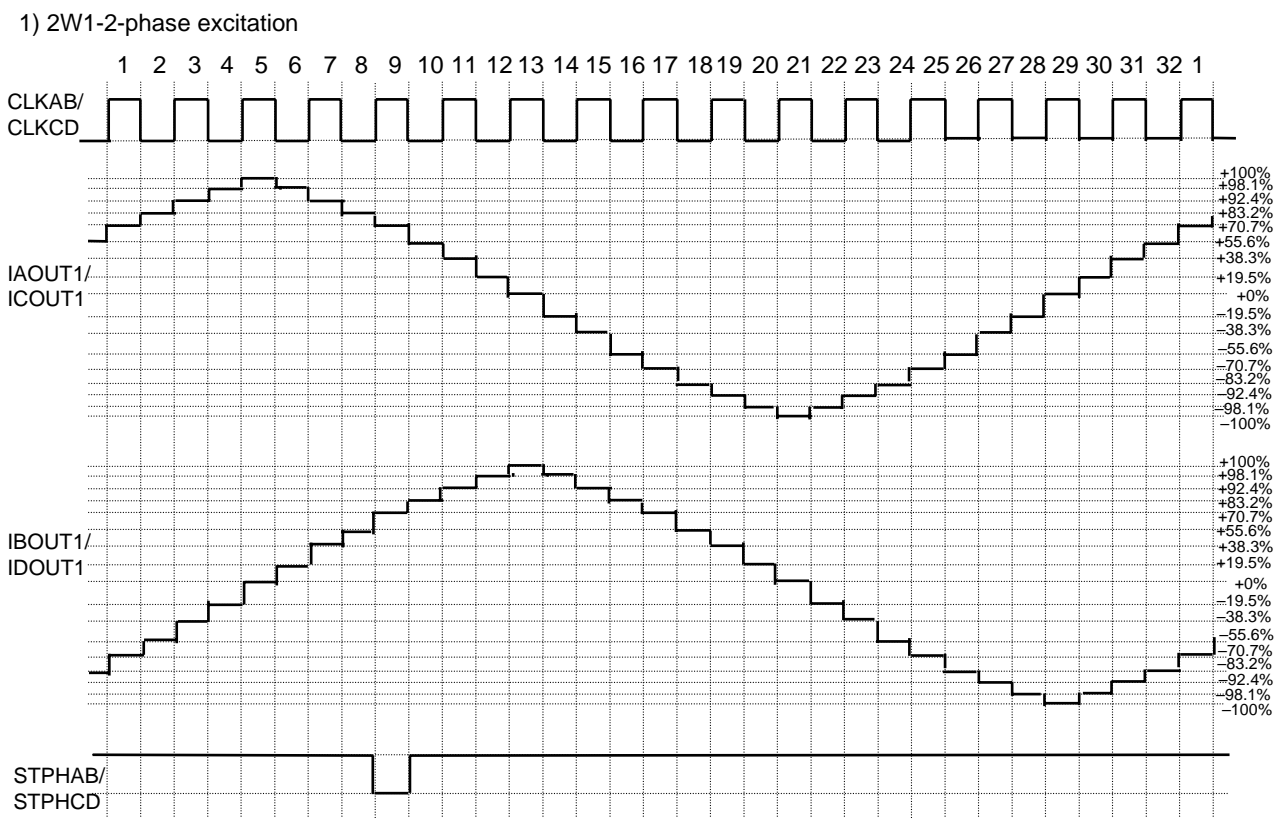

OPERATION (continued)

5. Home Position function(TEST=High)(continued)

Home Position output timing chart (DIRAB / DIRCD = Low) (continued)

2) W1-2-phase excitation

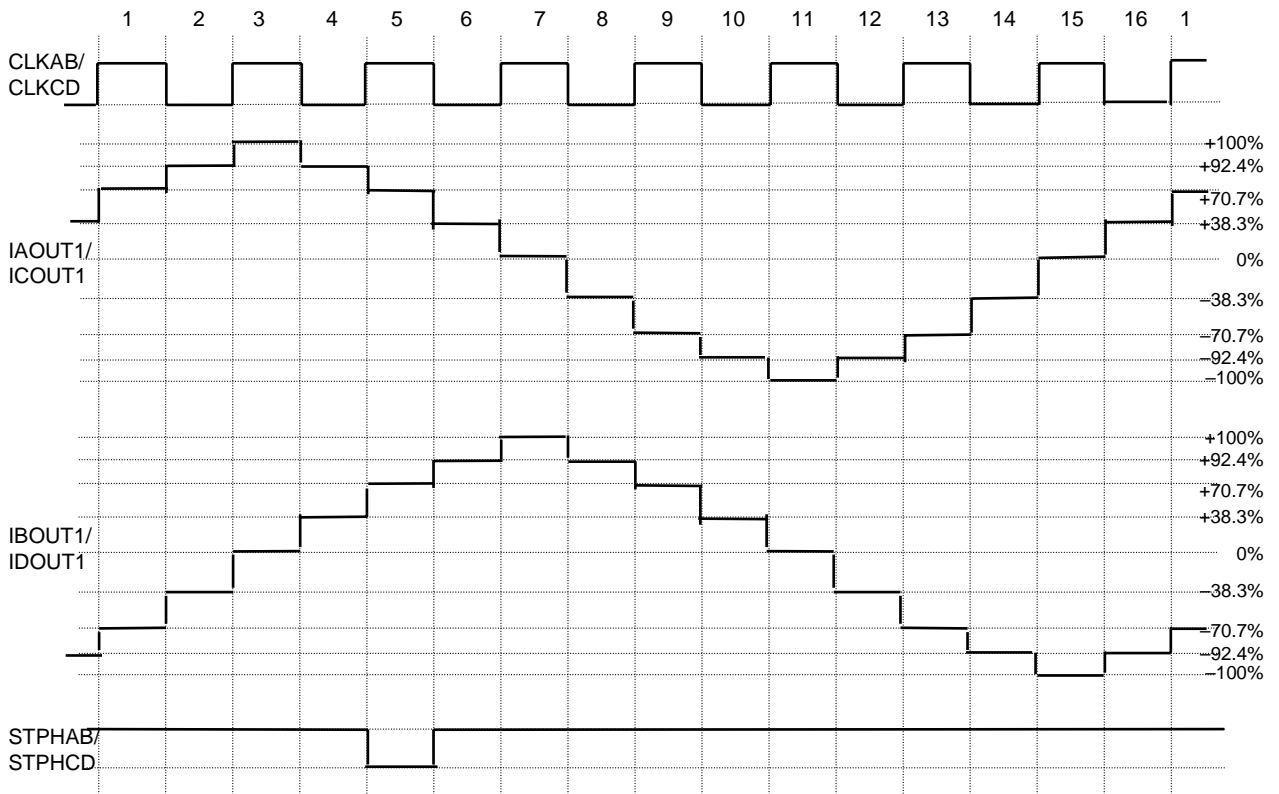

OPERATION (continued)

5. Home Position function (TEST=High) (continued)

Home Position output timing chart (DIRAB / DIRCD = Low)(continued)

3) 1-2-phase excitation

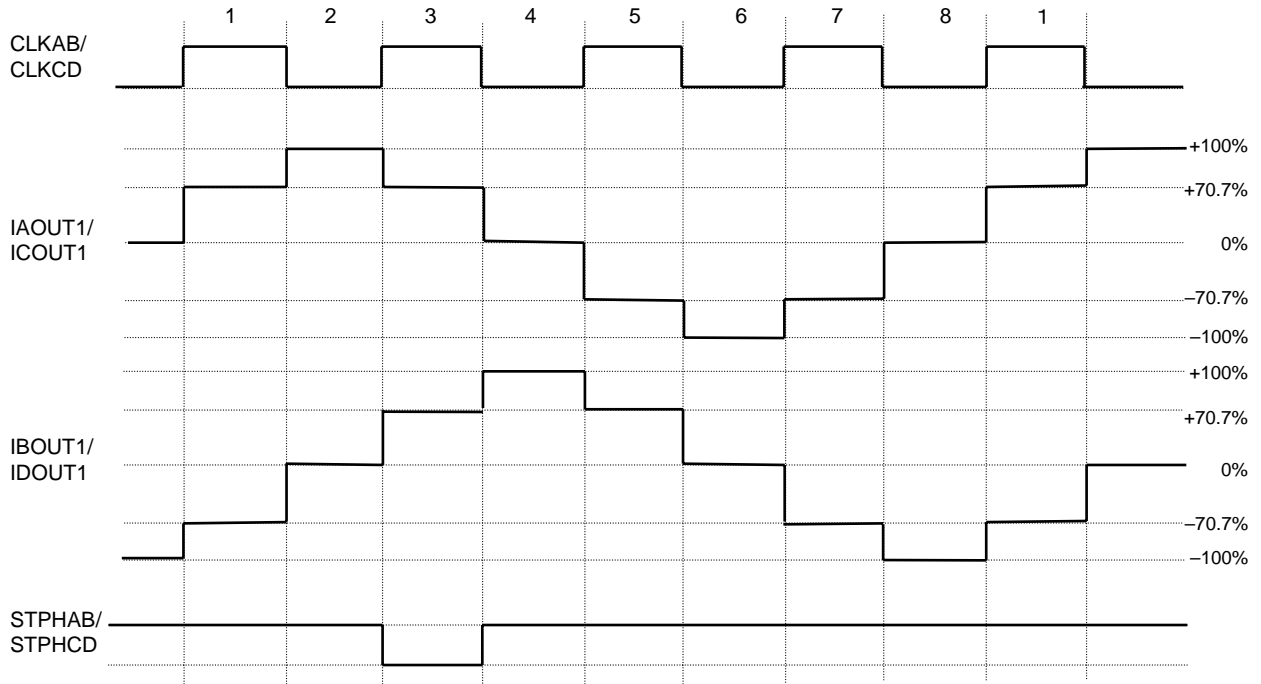

4) Half step

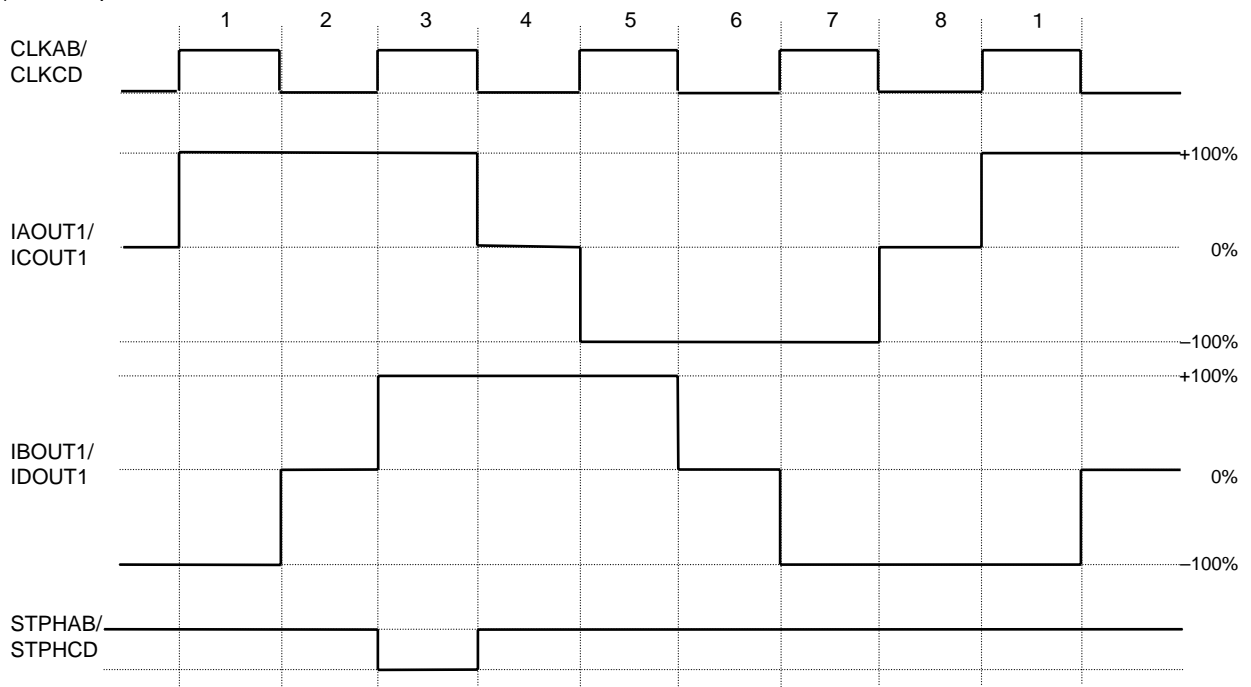

OPERATION (continued)

5. Home Position function (TEST=High) (continued)

Home Position output timing chart (DIRAB / DIRCD = Low) (continued)

5) 2-phase excitation

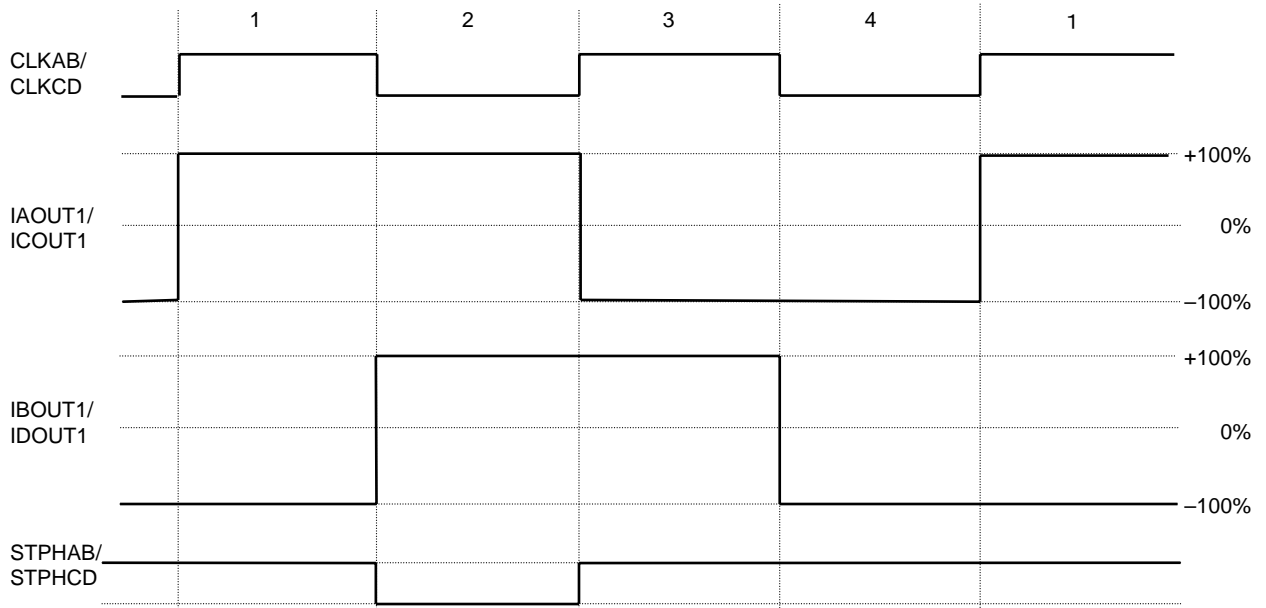

OPERATION (continued)

6. STEP detection output function (TEST = Low)

Whenever edges signal is input into clock input pins, this LSI outputs Low pulse signal from step detection output pins. The Low pulse width depend on each excitation mode. Refer to the below table. The STEP detection function becomes valid by setting TEST pin to Low. Connect pull-up resistor to supply voltage (Recommendation : S5VOUT), because STPHAB pin and STPHCD pin are composed by open drain circuit. The recommended value of pull-up resistor is 10 kΩ.

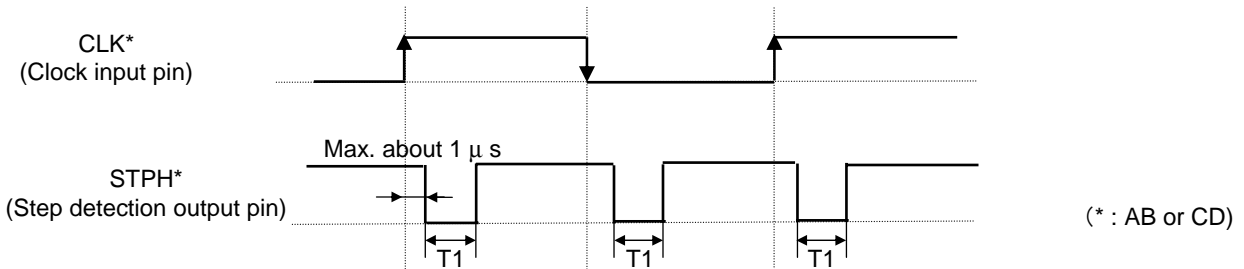

Table Step detection output pulse width

	2-phase excitation	Half step / 1-2 phase excitation	W1-2-phase excitation	2W1-2-phase excitation
Pulse width (T1)	About 20 μs	About 20 μs	About 10 μs	About 5 μs

7. Over-current protection function

This LSI has over-current protection (OCP) circuit to protect from the ground-fault etc. of the motor output. When motor current more than setting value flows to power MOS for about 3.8 μs (Typ.) due to the ground-fault, all motor outputs are turned OFF by latch operation. OCP is canceled by STBY = Low or UVLO (Under-voltage lockout) operation. However, the OCP circuit do not guaranteed the protection circuit of set. Therefore, do not use the OCP function of this LSI to protect a set. Note that this LSI might break before the protection function operates when it instantaneously exceeds the safe operation area and the maximum rating. When the inductor element is large due to the length of wiring at ground-fault, note that this LSI might break. Because the motor output voltage falls on a negative voltage or excessively rises after motor current excessively flows to motor outputs. The setup current of the OCP (reference) is as follows.

Table Over-current protection setup current (Typ. value)

	A/Bch motor output	C/Dch motor output
Setup current	2.2 A	3.3 A

8. About inputting the supply voltage to IF pins when VM power supply is not applied.

This LSI does the measures of error for inputting voltage to IF pins when VM power supply is not applied.

IF pin : ENABLE*, DIR*, ST1*, ST2*, ST3*, CLK*, STBY, VREF* (* : AB or CD)

Therefore, this LSI doesn't break and it doesn't cause error operation by the input voltage to the IF pins when VM supply voltage is not supplied.

APPLICATIONS INFORMATION

1. Notes

1) Pulse blanking time

This LSI has pulse blanking time (0.7 μs/Typ. value) to prevent erroneous current detection caused by noise. Therefore, the motor current value will not be less than current determined by pulse blanking time. Pay attention at the time of low current control. The relation between pulse blanking time and minimum current value is shown as Chart 1. In addition, increase-decrease of motor current value is determined by L value, wire wound resistance, induced voltage and PWM on Duty inside a motor.

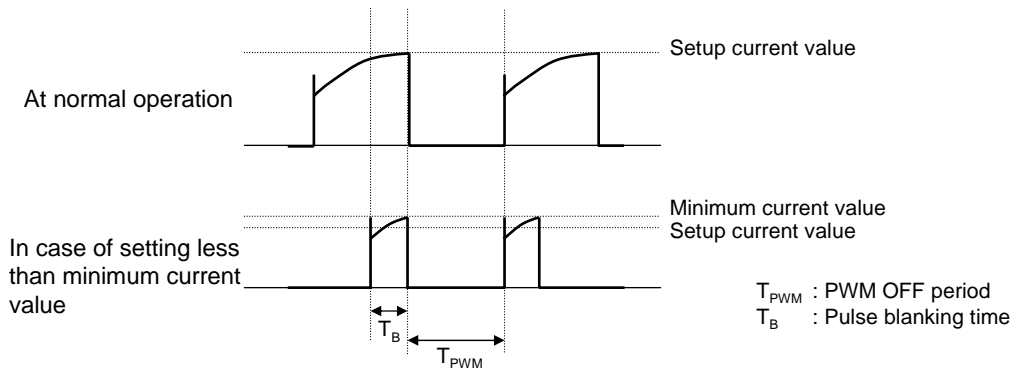

Chart 1. RCS current waveform

2) VREF voltage

When VREF* voltage is set to Low-level, erroneous detection of current might be caused by noise because threshold of motor current detection comparator becomes low (= VREF/10 × motor current ratio [%]).

Use this LSI after confirming no misdetection with setup VREF* voltage.

If VREF* pin is open, input voltage might be irregular and rise, a large current might flow to the output. Therefore do not use on condition that VREF* pin is open.

3) Notes on interface

Absolute maximum of Pin 6 to 8, Pin 12, Pin 21 to 23, Pin 34 to 40 and Pin 44 to 51 is -0.3 V to 6 V. When the setup current for a motor is large and lead line of GND is long, GND pin potential might rise. Take notice that interface pin potential is negative to difference in potential between GND pin reference and interface pin in spite of inputting 0 V to the interface pin. At that time, pay attention allowable voltage range must not be exceeded.

4) Notes on test mode

When inputting voltage of above 0.6 V and below 4.0 V to TEST (Pin 12), this LSI might become test mode.

When disturbance noise etc. makes this LSI test mode, motor might not operate normally. Therefore, use this LSI on condition that TEST pin is shorted to GND or S5VOUT at normal motor operation.

APPLICATIONS INFORMATION (continued)

1. Notes (continued)

5) Notes on Standby mode release / Under-voltage lockout release

This LSI has all motor outputs OFF period of about 100 μ s (typ) owing to release of Standby and UVLO (Refer to the below figure).

This is why restart from Standby and UVLO after charge pump voltage rises sufficiently because charge pump operation stops at Standby and UVLO.

When the charge pump voltage does not rise sufficiently during all motor outputs OFF period due to that capacitance between VPUMP and GND becomes large etc., the LSI might overheat and it might not operate normally. In this case, release Standby and UVLO at ENABLE = Low-level, and restart at ENABLE = High-level after the charge pump voltage rises sufficiently.

Moreover, take notice that state of motor current becomes default position at Standby and UVLO operation following as 1. Notes No.6.

After all motor outputs OFF period, the ground-fault detection period is set to about 6.4 μ s in order to detect the ground-fault of motor output before motor is turned on.

All the upper side power MOS are turned on during the above ground fault detection period, and then whether the ground-fault occurs or not is checked. (Refer to the following contents.)

If the ground-fault is detected at that time, all motor outputs are turned off, and motor drive stops.

[At Standby release]

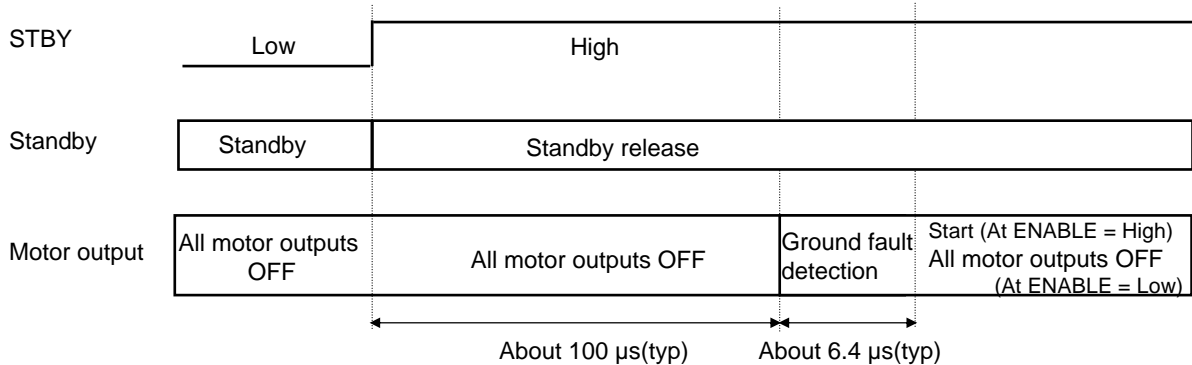

[At under-voltage lockout release]

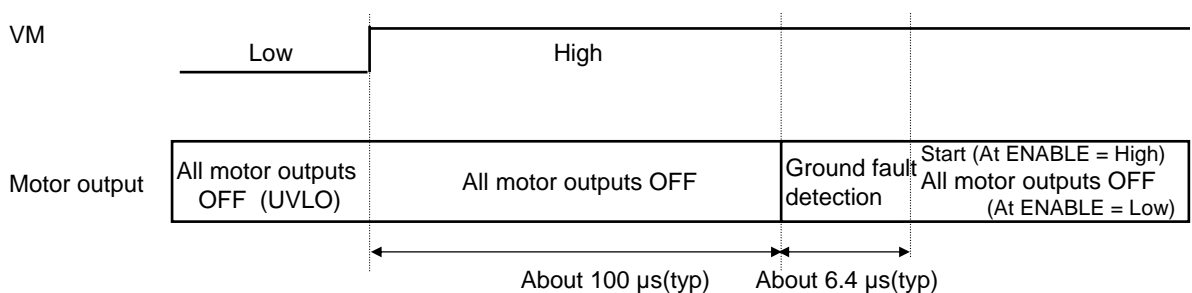

APPLICATIONS INFORMATION (continued)

1. Notes (continued)

6) Default of motor current state

The defaults of motor current state after the releases of UVLO and standby in each excitation mode are as follows.

Table Default position of each excitation mode

Excitation mode	Default electrical angle*
2-phase excitation (4-step)	-45°
Half step (8-step)	-45°
1-2 phase excitation (8-step)	-45°
W1-2 phase excitation (16-step)	-45°
2W1-2 phase excitation (32-step)	-45°

*Definition of electric angle

Electric angle is defined as 0° on the conditions of AOUT1/COU1

current = 100% and BOUT1/DOU1 current = 0%.

It is defined at DIR = Low as "+" direction.

It is defined at DIR = High as "-" direction.

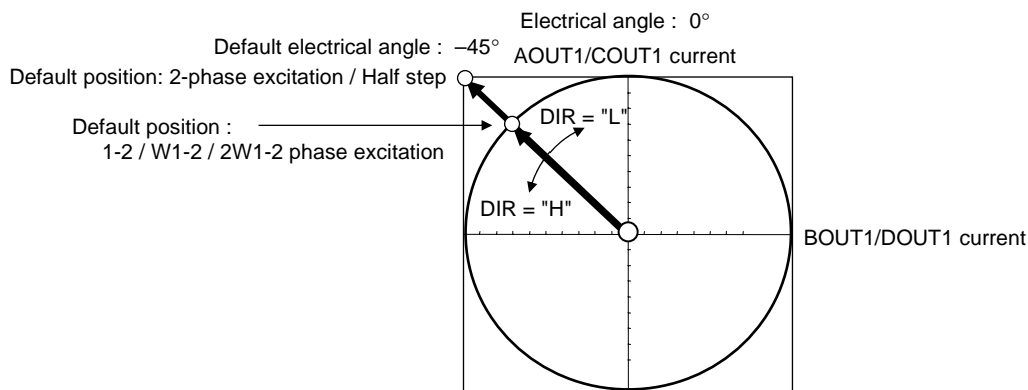

7) CLK* input signal and DIR* input signal

The set/hold time of CLK* and DIR* input signals, CLK* input minimum pulse width (High/Low) are as follows. Input signals after securing set/hold time.

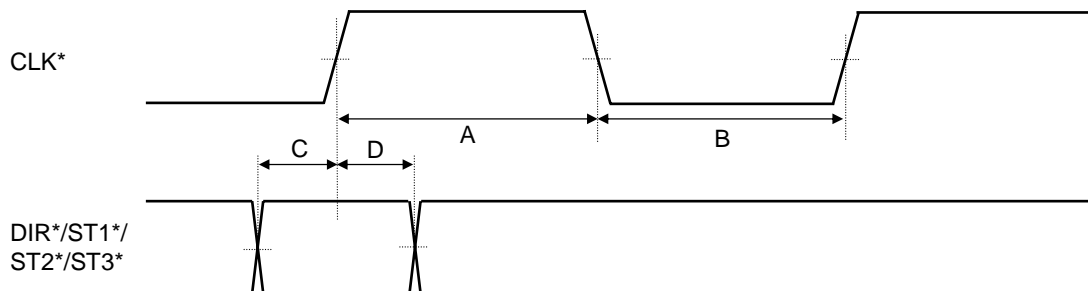

Period	Contents	Time
A	CLK* input minimum pulse width (High)	10 μs or more
B	CLK* input minimum pulse width (Low)	10 μs or more
C	DIR*/ST1*/ST2*/ST3* set time	2 μs or more
D	DIR*/ST1*/ST2*/ST3* hold time	2 μs or more

* : AB or CD

APPLICATIONS INFORMATION (continued)

1. Notes (continued)

8) CLK input at ENABLE = Low

As the below figure (Ex. 1-2 phase excitation), when inputting CLKAB at the time of motor stop and ENABLEAB = Low (all motor outputs OFF → Motor current = 0 A), the setup value of motor current will proceed at CLKAB input. Therefore, in case of restart at ENABLEAB = High, take notice that the position of restart is where the current state just before motor stop gains CLKAB input. For IBOU_T, ICOU_T and IDOU_T, the operation is same as the below.

Example) 1-2 phase excitation

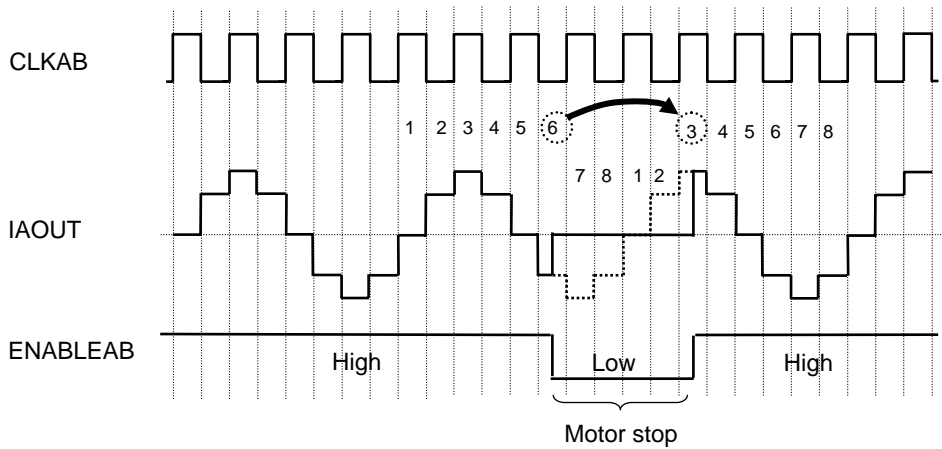

In spite of stop at state[6] , because CLKAB is input at ENABLEAB = Low, the motor will restart after ENABLEAB = High at state [3].

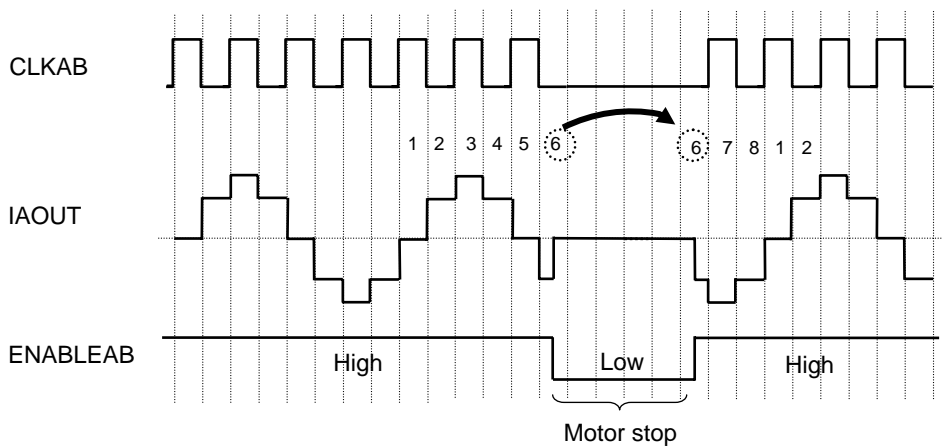

In spite of stop at state [6] , because CLKAB is not input at ENABLEAB = Low, the motor will restart after ENABLE AB= High at state [6] just before stop.

APPLICATIONS INFORMATION (continued)

1. Notes (continued)

9) Notes on RCS line

Take consideration in the below figure and the points and design PCB pattern.

(1) Point 1

Design so that the wiring to the current detection pin (RCSA/RCSB/RCSC/RCSD pin) of this LSI is thick and short to lower impedance. This is why current can not be detected correctly owing to wiring impedance and current might not be supplied to a motor sufficiently.

(2) Point 2

Design so that the wiring between current detection resistor and connector GND (the below figure Point 2) is thick and short to lower impedance. As the same as Point 1, sufficient current might not be supplied due to wiring impedance. In addition, if there is a common impedance on the side of GND of RCSA/RCSB/RCSC/RCSD, peak detection might be erroneous detection. Therefore, install the wiring on the side of GND of RCSA/RCSB/RCSC/RCSD independently.

(3) Point 3

Connect GND pin of this LSI to the connector on PCB independently. Separate the wiring removed current detection resistor of large current line (Point 2) from GND wiring and make these wirings one-point shorted at the connector as the below figure. That can make fluctuation of GND minimum.

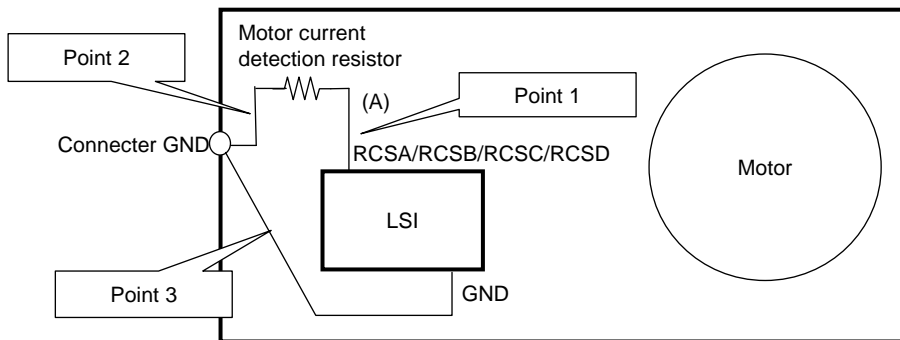

10) A high current flows into the LSI. Therefore, the common impedance of PCB can not be ignored. Take the following points into consideration and design the PCB pattern for a motor. Because the wiring connecting to VM1 (Pin 43) and VM2 (Pin 41) of this LSI is high-current, it is easy to generate noise at time of switching by wiring L. That might cause malfunction and destruction (Figure 1). As Figure 2, the escape way of the noise is secured by connecting a capacitor to the connector close to the VM pin of the LSI. This makes it possible to suppress the fluctuation of direct VM pin voltage of the LSI. Make the setting as shown in Figure 2 as much as possible.

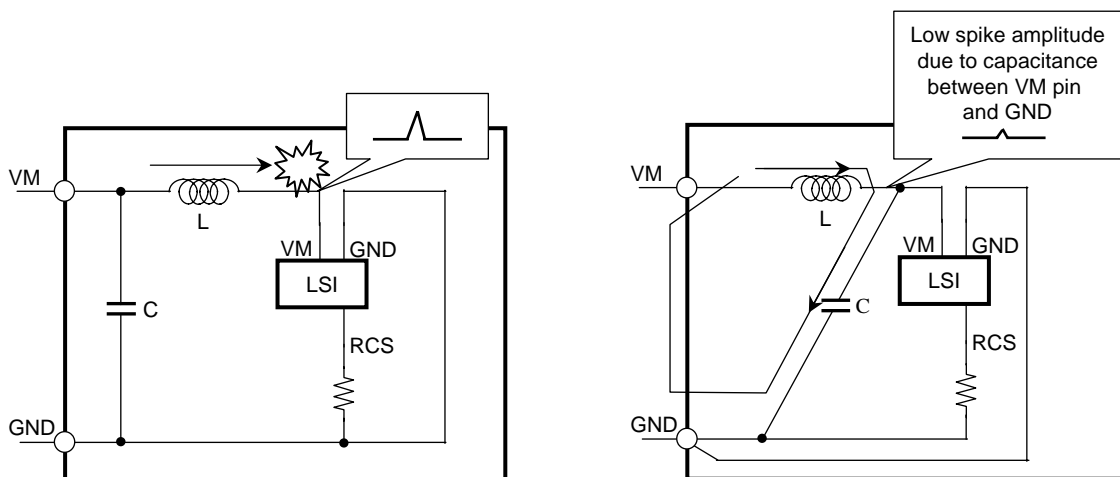

Figure 1. No recommended pattern

Figure 2. Recommended pattern

APPLICATIONS INFORMATION (continued)

1. Notes (continued)

11) LSI junction temperature

In case of measuring chip temperature of this LSI, measure the voltage of TjmonABCD pin (Pin 10) and estimate the chip temperature from the data below. However, because this data is technical reference data, conduct a sufficient reliability test of the LSI and evaluate the product with the LSI incorporated.

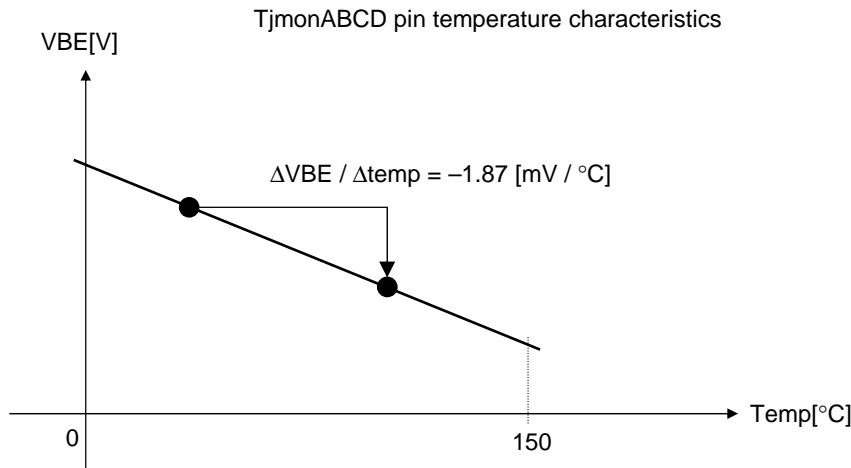

12) Power-on and Supply voltage change

When supplying to VM pin (Pin 41, 43) or raising supply voltage, set the rise speed of VM voltage to less than 0.1 V/μs . If the rise speed of supply voltage is too rapid, it might cause error of operation and destruction of the LSI. If the rise speed of VM voltage is more rapid than 0.1V/μs, conduct a sufficient reliability test and also check a sufficient evaluation for a product.

In addition, rise the VM supply voltage in an ENABLE = Low state when change VM supply voltage from low voltage to high voltage within the operating supply voltage range.

Since there is not the all motor outputs OFF period shown in 1. Notes No.5 for the supply voltage change within the operating supply voltage range, the VPUMP voltage is in a low voltage state due to not following to VM supply voltage change enough, and this LSI might not operate normally.

Therefore, restart this LSI by setting ENABLE to High after the VPUMP voltage rises enough.

In addition, it is recommended to fall VM voltage in motor stop state (ENABLEAB/CD = Low or STBY = Low) for the stable fall of supply voltage.

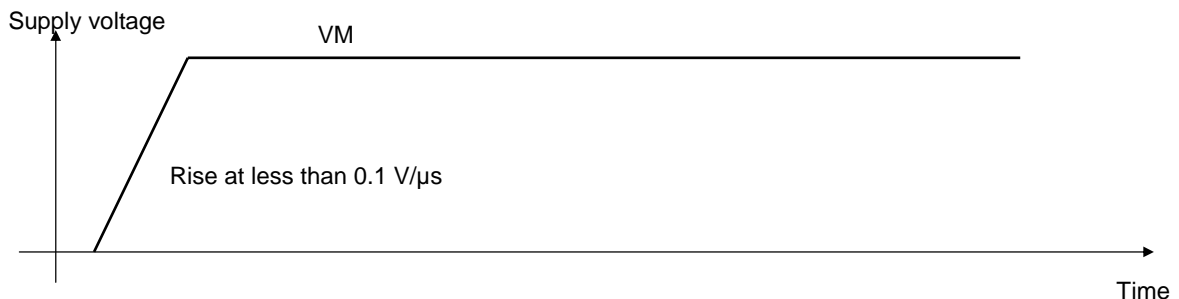

13) Pins to set mode

- As for the High/Low setting of DECAY1AB, DECAY2AB, DECAY1CD, DECAY2CD, PWMSWAB and PWMSWCD, it is recommended to short to GND or S5VOUT. If the above pins are high-impedance such as open, note that this LSI might not operate normally because it easily influences the noise
- PWMSWAB/CD can be set to Middle by setting PWMSWAB/CD to Open. However, it might occur the error of operation due to the noise. In case, connect the capacity of 0.01 μF or more between PWMSWAB/CD and GND .

PACKAGE INFORMATION (Reference Data)

Package Code:HSOP056-P-0300B

unit:mm

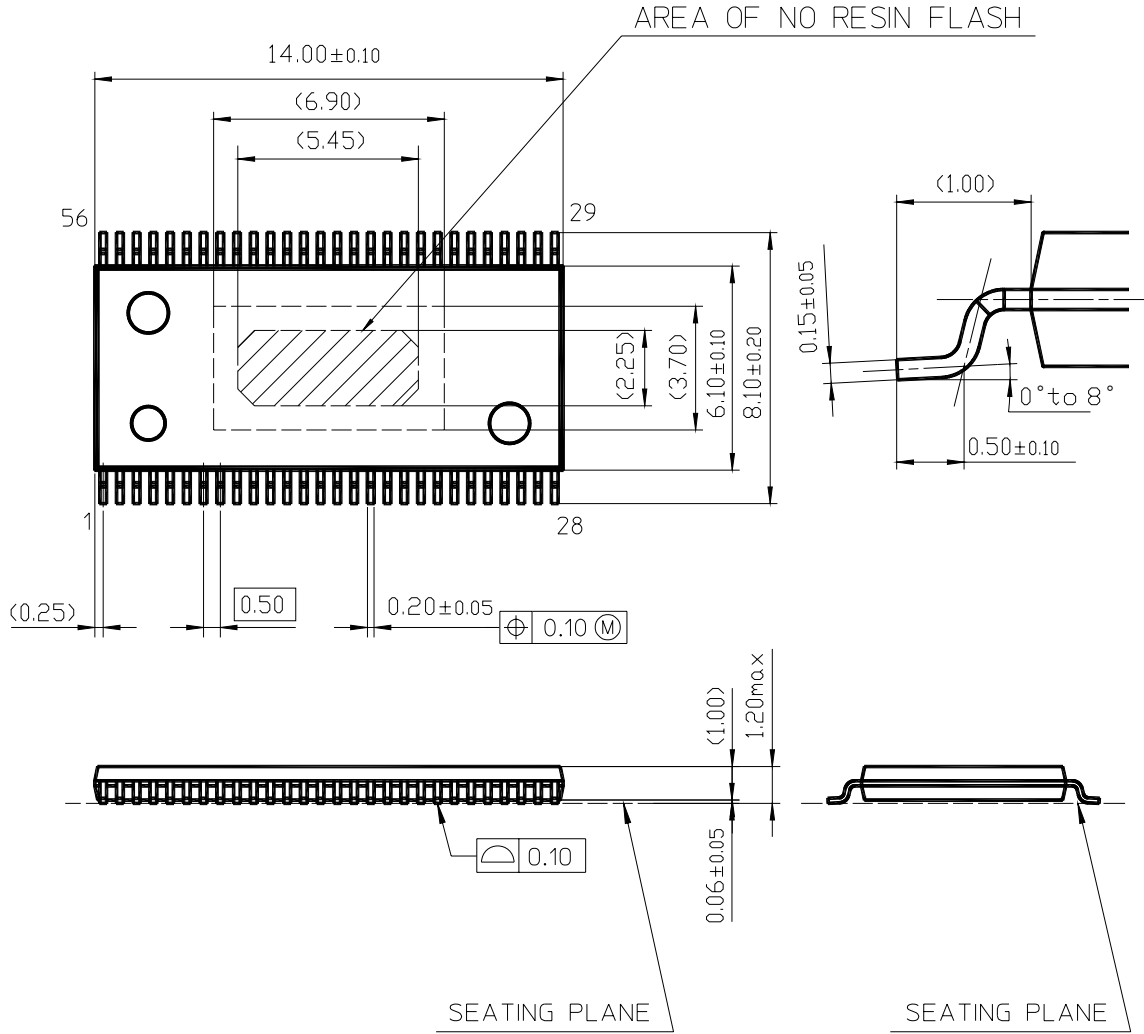

Body Material	: Epoxy Resin
Lead Material	: Cu Alloy
Lead Finish Method	: Pd Plating

IMPORTANT NOTICE

1. The products and product specifications described in this book are subject to change without notice for modification and/or improvement. At the final stage of your design, purchasing, or use of the products, therefore, ask for the most up-to-date Product Standards in advance to make sure that the latest specifications satisfy your requirements.
2. When using the LSI for new models, verify the safety including the long-term reliability for each product.
3. When the application system is designed by using this LSI, be sure to confirm notes in this book.
Be sure to read the notes to descriptions and the usage notes in the book.
4. The technical information described in this book is intended only to show the main characteristics and application circuit examples of the products. No license is granted in and to any intellectual property right or other right owned by Panasonic Corporation or any other company. Therefore, no responsibility is assumed by our company as to the infringement upon any such right owned by any other company which may arise as a result of the use of technical information de-scribed in this book.
5. This book may be not reprinted or reproduced whether wholly or partially, without the prior written permission of our company.
6. This LSI is intended to be used for general electronic equipment [Stepping motor drive].
Consult our sales staff in advance for information on the following applications: Special applications in which exceptional quality and reliability are required, or if the failure or malfunction of this LSI may directly jeopardize life or harm the human body.
Any applications other than the standard applications intended.
 - (1) Space appliance (such as artificial satellite, and rocket)
 - (2) Traffic control equipment (such as for automobile, airplane, train, and ship)
 - (3) Medical equipment for life support
 - (4) Submarine transponder
 - (5) Control equipment for power plant
 - (6) Disaster prevention and security device
 - (7) Weapon
 - (8) Others : Applications of which reliability equivalent to (1) to (7) is required
 It is to be understood that our company shall not be held responsible for any damage incurred as a result of or in connection with your using the LSI described in this book for any special application, unless our company agrees to your using the LSI in this book for any special application.
7. This LSI is neither designed nor intended for use in automotive applications or environments unless the specific product is designated by our company as compliant with the ISO/TS 16949 requirements.
Our company shall not be held responsible for any damage incurred by you or any third party as a result of or in connection with your using the LSI in automotive application, unless our company agrees to your using the LSI in this book for such application.
8. If any of the products or technical information described in this book is to be exported or provided to non-residents, the laws and regulations of the exporting country, especially, those with regard to security export control, must be observed.
9. Please use this product in compliance with all applicable laws and regulations that regulate the inclusion or use of controlled substances, including without limitation, the EU RoHS Directive. Our company shall not be held responsible for any damage incurred as a result of your using the LSI not complying with the applicable laws and regulations.

USAGE NOTES

1. When designing your equipment, comply with the range of absolute maximum rating and the guaranteed operating conditions (operating power supply voltage and operating environment etc.). Especially, please be careful not to exceed the range of absolute maximum rating on the transient state, such as power-on, power-off and mode-switching. Otherwise, we will not be liable for any defect which may arise later in your equipment.

Even when the products are used within the guaranteed values, take into the consideration of incidence of break down and failure mode, possible to occur to semiconductor products. Measures on the systems such as redundant design, arresting the spread of fire or preventing glitch are recommended in order to prevent physical injury, fire, social damages, for example, by using the products.

2. Comply with the instructions for use in order to prevent breakdown and characteristics change due to external factors (ESD, EOS, thermal stress and mechanical stress) at the time of handling, mounting or at customer's process. When using products for which damp-proof packing is required, satisfy the conditions, such as shelf life and the elapsed time since first opening the packages.
3. Pay attention to the direction of LSI. When mounting it in the wrong direction onto the PCB (printed-circuit-board), it might smoke or ignite.
4. Pay attention in the PCB (printed-circuit-board) pattern layout in order to prevent damage due to short circuit between pins. In addition, refer to the Pin Description for the pin configuration.
5. Perform a visual inspection on the PCB before applying power, otherwise damage might happen due to problems such as a solder-bridge between the pins of the semiconductor device. Also, perform a full technical verification on the assembly quality, because the same damage possibly can happen due to conductive substances, such as solder ball, that adhere to the LSI during transportation.
6. Take notice in the use of this product that it might break or occasionally smoke when an abnormal state occurs such as output pin-VM short (Power supply fault), output pin-GND short (Ground fault), or output-to-output-pin short (load short) .
Especially, for the pins below, take notice Power supply fault, Ground fault, short to motor current detection pin, load short and short between the pin.

- Motor drive output pin (Pin 1, 5, 24, 28, 29, 33, 52, 56)
- Motor current detection pin (Pin 3, 26, 31, 54)
- Charge pump circuit pin (Pin 16, 17, 18)
- Power supply (Pin 41, 43)

And, safety measures such as an installation of fuses are recommended because the extent of the above-mentioned damage and smoke emission will depend on the current capability of the power supply.

7. The protection circuit is for maintaining safety against abnormal operation. Therefore, the protection circuit should not work during normal operation.
Especially for the thermal protection circuit, if the area of safe operation or the absolute maximum rating is momentarily exceeded due to output pin to VM short (Power supply fault), or output pin to GND short (Ground fault), the LSI might be damaged before the thermal protection circuit could operate.
8. Unless specified in the product specifications, make sure that negative voltage or excessive voltage are not applied to the pins because the device might be damaged, which could happen due to negative voltage or excessive voltage generated during the ON and OFF timing when the inductive load of a motor coil or actuator coils of optical pick-up is being driven.
9. The product which has specified ASO (Area of Safe Operation) should be operated in ASO.
10. Verify the risks which might be caused by the malfunctions of external components.

USAGE NOTES (continued)

11. Connect the metallic plate (fin) on the back side of the LSI with the GND potential. The thermal resistance and the electrical characteristics are guaranteed only when the metallic plate (fin) is connected with the GND potential.
12. Confirm characteristics fully when using the LSI.
Secure adequate margin after considering variation of external part and this LSI including not only static characteristics but transient characteristics. Especially, Pay attention that abnormal current or voltage must not be applied to external parts because the pins (Pin 1, 5, 16, 17, 18, 24, 28, 29, 33, 52, 56) output high current or voltage.
13. Design the heat radiation with sufficient margin so that Power dissipation must not be exceeded base on the conditions of power supply voltage, load and ambient temperature.
(It is recommended to design to set connective parts to 70% to 80% of maximum rating)
14. Set capacitance value between VPUMP and GND so that VPUMP (Pin 18) must not exceed 43 V transiently at the time of motor standby to motor start.
15. This LSI employs a PWM drive method that switches the high-current output of the output transistor. Therefore, the LSI is apt to generate noise that may cause the LSI to malfunction or have fatal damage. To prevent these problems, the power supply must be stable enough. Therefore, the capacitance between the S5VOUT and GND pins must be a minimum of 0.1 μ F and the one between the VM and GND pins must be a minimum of 47 μ F and as close as possible to the LSI so that PWM noise will not cause the LSI to malfunction or have fatal damage.

Request for your special attention and precautions in using the technical information and semiconductors described in this book

- (1) If any of the products or technical information described in this book is to be exported or provided to non-residents, the laws and regulations of the exporting country, especially, those with regard to security export control, must be observed.
- (2) The technical information described in this book is intended only to show the main characteristics and application circuit examples of the products. No license is granted in and to any intellectual property right or other right owned by Panasonic Corporation or any other company. Therefore, no responsibility is assumed by our company as to the infringement upon any such right owned by any other company which may arise as a result of the use of technical information described in this book.
- (3) The products described in this book are intended to be used for general applications (such as office equipment, communications equipment, measuring instruments and household appliances), or for specific applications as expressly stated in this book.
Consult our sales staff in advance for information on the following applications:
 - Special applications (such as for airplanes, aerospace, automotive equipment, traffic signaling equipment, combustion equipment, life support systems and safety devices) in which exceptional quality and reliability are required, or if the failure or malfunction of the products may directly jeopardize life or harm the human body.It is to be understood that our company shall not be held responsible for any damage incurred as a result of or in connection with your using the products described in this book for any special application, unless our company agrees to your using the products in this book for any special application.
- (4) The products and product specifications described in this book are subject to change without notice for modification and/or improvement. At the final stage of your design, purchasing, or use of the products, therefore, ask for the most up-to-date Product Standards in advance to make sure that the latest specifications satisfy your requirements.
- (5) When designing your equipment, comply with the range of absolute maximum rating and the guaranteed operating conditions (operating power supply voltage and operating environment etc.). Especially, please be careful not to exceed the range of absolute maximum rating on the transient state, such as power-on, power-off and mode-switching. Otherwise, we will not be liable for any defect which may arise later in your equipment.
Even when the products are used within the guaranteed values, take into the consideration of incidence of break down and failure mode, possible to occur to semiconductor products. Measures on the systems such as redundant design, arresting the spread of fire or preventing glitch are recommended in order to prevent physical injury, fire, social damages, for example, by using the products.
- (6) Comply with the instructions for use in order to prevent breakdown and characteristics change due to external factors (ESD, EOS, thermal stress and mechanical stress) at the time of handling, mounting or at customer's process. When using products for which damp-proof packing is required, satisfy the conditions, such as shelf life and the elapsed time since first opening the packages.
- (7) This book may be not reprinted or reproduced whether wholly or partially, without the prior written permission of our company.