

# AN5025K

## Remote Control Receiving IC

### Overview

The AN5025K is an integrated circuit for the receiving preamplifier of the infrared remote control system, and consists of the first amplifier, limiter amplifier, BPF, signal waveform detector, and waveform shaping circuit.

### Features

- Band pass filter built-in  
(tuning frequency can be changed from 30 to 60kHz by the external resistor.)
- TTL and CMOS can be connected directly to the output pin.
- Active high logic system.

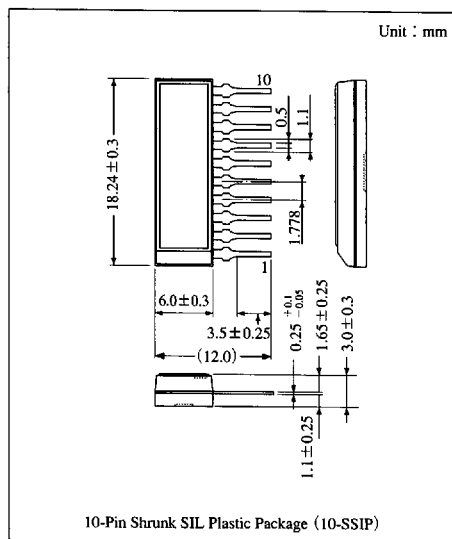

### Block Diagram

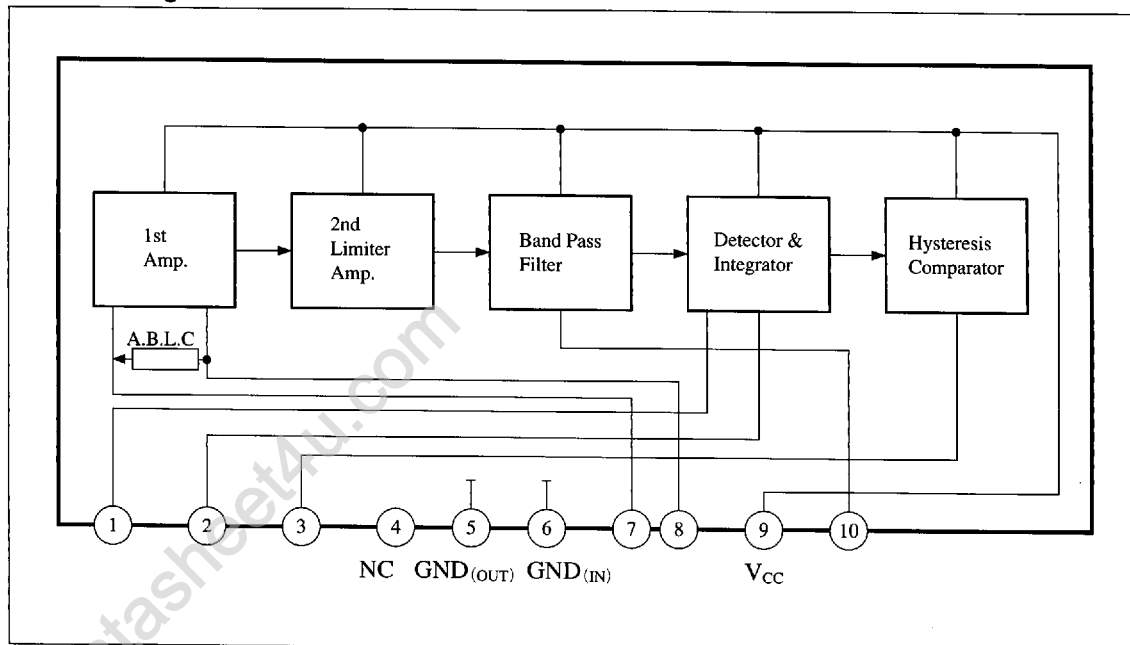

6932852 0014145 532

Panasonic

**■ Absolute Maximum Ratings (Ta=25°C)**

Parameter	Symbol	Rating	Unit
Supply voltage	V <sub>CC</sub>	6	V
Circuit voltage	V <sub>1-6</sub>	0 to V <sub>9-6</sub>	V
	V <sub>2-6</sub>	0.5 to V <sub>9-6</sub>	
	V <sub>7-6</sub>	0 to V <sub>9-6</sub>	
	V <sub>8-6</sub>	0 to V <sub>9-6</sub>	
Supply current	I <sub>CC</sub>	10	mA
Circuit current	I <sub>3</sub>	-0.05 to +2	mA
	I <sub>10</sub>	0 to 0.1	
Power dissipation	P <sub>D</sub>	60	mW
Operating ambient temperature	T <sub>opr</sub>	-20 to +70	°C
Storage temperature	T <sub>stg</sub>	-55 to +150	°C

**■ Recommended Operating Range (Ta=25°C)**

Parameter	Symbol	Range
Operating supply voltage range	V <sub>CC</sub>	4.5V to 5.5V

**■ Electrical Characteristics (Ta=25°C)**

Parameter	Symbol	Condition	min	typ	max	Unit
Circuit current	I <sub>9</sub>	V <sub>9-6</sub> =5V	1	2	3	mA
Pin② voltage	V <sub>2-6</sub>	V <sub>1-6</sub> =2.6V	0.6	0.8	1.2	V
Pin⑦ voltage	V <sub>7-6</sub>	V <sub>9-6</sub> =5V	2.5	3	3.5	V
Output low level voltage ①	V <sub>3-6</sub>	V <sub>9-6</sub> =5.5V, V <sub>2-6</sub> =1.4V	-50	100	400	mV
Output high level voltage ②	V <sub>3-6</sub>	V <sub>9-6</sub> =5.5V, V <sub>2-6</sub> =3.4V	5.3	5.5	—	V
Voltage gain	A <sub>v</sub>	v <sub>in</sub> =20μV <sub>r-p</sub> , f=56.9kHz	74	78	82	dB
Detection sensitivity	v <sub>det</sub>	f <sub>0</sub> =56.9kHz, f=f <sub>0</sub> ±6.5kHz, Burst wave *	—	0.1	1.5	V



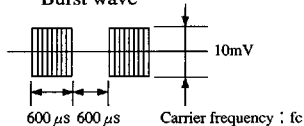



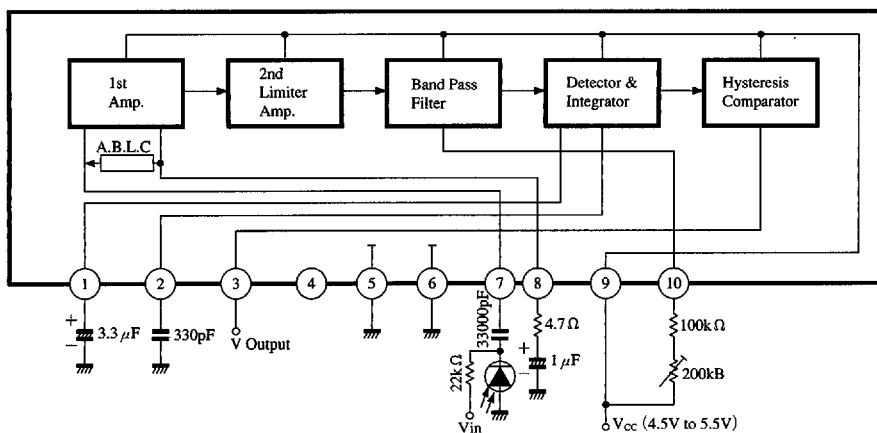

\* Burst wave

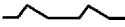
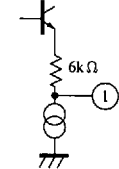

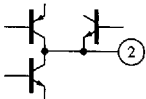
**■ Application Circuit**

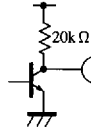

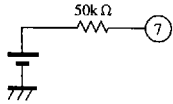
### Pin Descriptions

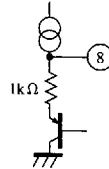
Pin No.	Pin name	Typ. waveform	Description	I/O impedance	Equivalent circuit
1	Detecting capacitor pin		To detect a signal, smooth a signal, make the DC level, and set the slice level.	6k $\Omega$	
2	Integral capacitor pin		Capacitor pin covering the integrated current to the voltage for AM-detection of signal. decrease capacitor $\rightarrow$ increase sensitivity.	<100k $\Omega$	
3	Output pin		The pulse signal that the remote-controlled signal was AM-detected is output by 0 to V <sub>CC</sub> .	20k $\Omega$	
—	NC	—	NC	—	—
5	Output GND pin	—	GND pin on the output side. In pattern-layout, this pin should come closer to the external GND pins, Pin① and Pin②.	—	—
6	Input GND pin	—	GND pin on the input side. So, pattern-layout of this pin may come closer to the external parts GND pin of Pin⑦ and Pin⑧.	—	—
7	Input pin		Pin for converting the light received by the pin diode to voltage.	50k $\Omega$	
8	1st Amp. gain setting pin		—pin of Op. Amp. that Pin⑧ assumed as + pin. The resistor of 1k $\Omega$ is built-in between this pin and Op. Amp output pin.	1k $\Omega$	
9	Power supply pin	—	Power pin. The applied voltage can be used over a range of from 4.5 to 5.5V.	—	—

ICs for TV

### ■ Pin Descriptions (cont.)

Pin No.	Pin name	Typ. waveform	Description	I/O impedance	Equivalent circuit
10	Tuning frequency setting pin	—	Pin for setting the tuning frequency of built-in BPF. The tuning frequency varies with the value of current flowing in this pin.	10k $\Omega$	