



Introduction



The approval by the IEEE of the 802.11 Standard for wireless LANs has given the WLAN industry a needed boost. Manufacturers of WLAN

systems are now cooperating in performing interoperability testing. Such testing is providing assurance that 802.11 compliant equipment purchased from one manufacturer will interoperate with 802.11 radios manufactured by other OEMs. This is an important consideration for MIS managers who desire to use WLAN technology to provide mobility with connectivity to their workforce.

The November 1997 approved 802.11 Standard defines the protocol and compatible interconnection of data communication equipment via radio or infrared air interface in a local area network. The radio implementation of the PHY, a subject of this paper, specifies the use of either Frequency-Hopping Spread Spectrum (FHSS) or Direct Sequence Spread Spectrum (DSSS) modulation. For frequency-hopping radios the IEEE specifies a minimum requirement of 1Mbit/s data rate using two-level Gaussian frequency shift keying (2GFSK) modulation. An optional rate of 2Mbit/s is supported using four-level Gaussian FSK (4GFSK) modulation. Figure 1 is a comparison of the signaling schemes for 802.11 2GFSK and 4GFSK. IEEE Std 802.11 specifies h_2 , the deviation factor, as 0.32 nominal for 2GFSK and $h_4 = 0.45 \times h_2$ nominal for 4GFSK.

For direct sequence systems two modulation formats and data rates are supported, a basic access rate of 1Mbit/s and an enhanced access rate of 2Mbit/s. Both data rates utilize phase shift keying modulation with differential binary phase shift keying (DBPSK) used for the 1Mbit/s basic access rate and differential quadrature phase shift keying (DQPSK) used for the enhanced access rate. These two techniques, FHSS and DSSS, constitute the currently approved standard for IEEE 802.11.

Another modulation technique known as M-ary Biorthogonal Keying (MBOK) has been used to achieve a 5.5X improvement

in data transmission rate when compared with that for DQPSK, and radios utilizing the MBOK modulation format have now achieved FCC certification. This application note provides an overview of several frequency hopping and direct sequence techniques used for wireless data transmission in the ISM band. Included is a discussion of how the MBOK modulation technique is able to achieve Ethernet speeds over three separate band-limited channels within the ISM band.

It will be shown that for a given increase in waveform complexity the MBOK modulation adds very little system complexity in terms of the number of components and radio bill of materials (BOM) cost, when compared to a 2Mbit/s radio with QPSK modulation.

A Variable Data Rate Radio

Figure 2 depicts a system implementation of a 2.4GHz DSSS radio called PRISM™ designed for operation in the unlicensed industrial, scientific and medical (ISM) band. By unlicensed band, we mean that frequency band of 2400MHz to 2483.5MHz allocated by the FCC wherein an intentional, unintentional or incidental radiator may be operated without an individual license [1]. This international band is also defined by regulatory agencies in Canada, Europe, and Japan although in a few countries minor differences in allocated frequencies are found. Table 1 shows the operating frequency ranges in effect internationally for the 2.4GHz ISM band [2].

TABLE 1. ISM BAND OPERATING FREQUENCIES

LOWER CARRIER FREQUENCY LIMIT (GHz)	UPPER CARRIER FREQUENCY LIMIT (GHz)	REGULATORY RANGE	GEOGRAPHY
2.402	2.480	2.400 to 2.4835	North America and Europe
2.473	2.495	2.471 to 2.497	Japan
2.447	2.473	2.445 to 2.475	Spain
2.448	2.482	2.4465 to 2.4835	France

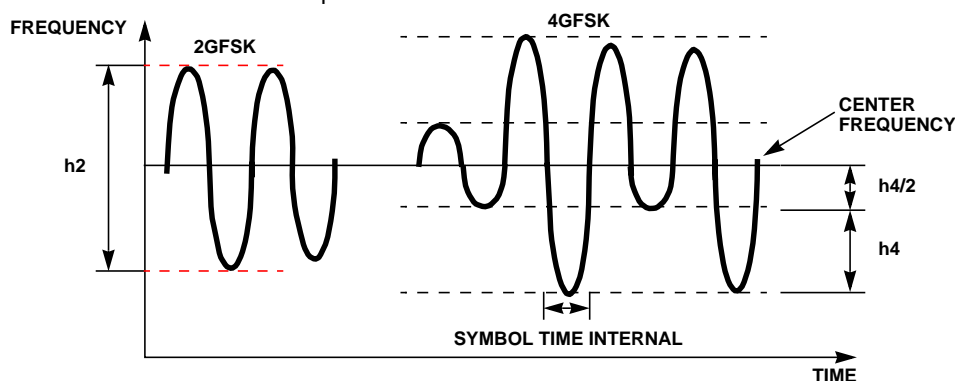

FIGURE 1. SIGNALING SCHEMES FOR 2GFSK AND 4GFSK MODULATION

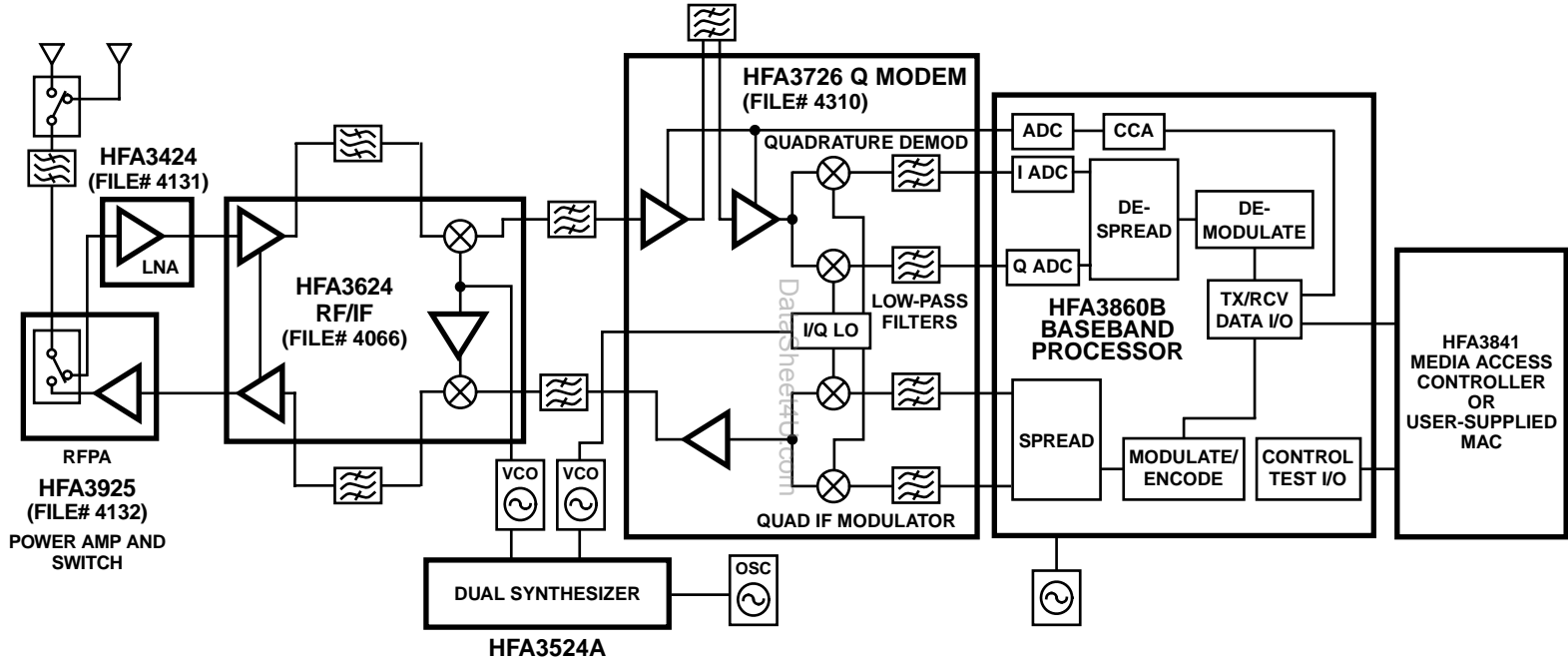

FIGURE 2. 2.4GHz PROGRAMMABLE RADIO FOR THE ISM BAND (PRISM)

The radio of Figure 2 features programmable data rate capability with high rates of 11, 5.5 and 4Mbit/s and IEEE Standard 802.11 fallback rates of 2 and 1Mbit/s. By definition the 1Mbit/s and 2Mbit/s data rates utilize DPSK modulation. The 4Mbit/s data rate mode also utilizes DPSK modulation at double the clock rate of the 2Mbit/s mode. For the higher data rates of 5.5Mbit/s and 11Mbit/s, the radio of Figure 2 utilizes MBOK modulation. MBOK modulation will be discussed following a review of some general topics in spread spectrum techniques. Since spread spectrum is a very broad topic, (no pun intended) the following discussion will be somewhat constrained within the context of FCC ISM band regulations and the requirements of the IEEE Std 802.11 specification.

Characteristics of Spread Spectrum Signals

The term spread spectrum is used to describe any technique in which the bandwidth of the transmitted signal is much wider than the bandwidth of the information signal. This is not to be confused with conventional wideband FM in which large deviation ratios tend to spread the spectrum of the FM signal. In the context of a definition of pure spread spectrum we mean only those techniques wherein the spread function is performed by some signal other than the information signal [3].

An astute reader might ask the question why with today's overcrowded frequency spectrum, would anyone want to spread the signal bandwidth thereby using up more precious frequency spectrum. The answer is evident when one considers the characteristics of spread spectrum signals that made them pervasive in military applications.

These characteristics are:

1. Low power spectral density so the information signal looks like noise to eavesdroppers or other radios.
2. High immunity to jamming and interference.
3. High resolution ranging.
4. Possibility for code division multiple access.

Recognizing these benefits, the FCC in 1985 made a decision to allow the use of spread spectrum signals in the ISM bands with power levels set at 1W maximum [3]. The FCC allows three types of spread spectrum signals in the ISM band, Frequency Hop (FH), direct sequence (DS) and hybrid FH/DS signals. The FCC regulations have no provision for chirp spread spectrum in the ISM bands.

Historical Background of Spread Spectrum

The early use of spread spectrum techniques can be traced back to developments in radar and ranging techniques during World War II. At that time, Germany was experimenting with pulse compression techniques that formed the basis for "chirp" spread spectrum systems [4]. With chirp spread spectrum a carrier is swept over a wide band during a given pulse interval. Chirp spread spectrum is also known as pulsed FM and is primarily used in radar applications. Frequency-hopping also traces its roots back to World War II and it is interesting that one of the first patents on a method for synchronizing frequency hopping

transmitters and receivers on submarines was held by the late actress Hedy Lamarr, an Austrian who had once been married to German munitions baron Fritz Mandl [5]. Beside the chirp and frequency hopping methods there are time hopping, direct sequence and hybrid combinations of frequency hopping, time hopping, and direct sequence modulations. Since their early uses during World War II, spread spectrum techniques have mostly been used by the military for secure, jam proof radios.

Today, spread spectrum techniques have found their way into many consumer and industrial applications such as PCS phones, cordless telephones, wireless card readers, bar code scanners, and other handheld portable appliances. Referring to Figure 2, note that with the exception of the proprietary HFA3860B baseband processor and the medium access controller (MAC) chip, all the RF/IF front end functional blocks are available from multiple IC vendors like National Semiconductor, MA-Com, IC Works, Intersil Corporation and others. The widespread availability of these components demonstrates that the technology for spread spectrum radio has moved from the esoteric, niche marketplace to high volume, commercial off-the-shelf manufacturing.

Definition of Orthogonal Signaling

The basic problem in digital communications is one of reliably selecting the actual transmitted signal from a set of M possible discrete signals. Here both the transmitter and receiver know the set of M signaling waveforms. Assume that we have a set $\{S_i(t)\}$ of M possible signals where:

$$1 \leq i \leq M \text{ and } 0 \leq t \leq T \text{ with } T \text{ being period of the signal.}$$

Given that the channel will corrupt the signal by superimposing additive white Gaussian noise (AWGN) on it, the receiver will observe a signal:

$$r(t) = S_i(t) + n(t)$$

where $n(t)$ = AWGN

It is the task of the receiver to determine the correct transmitted signal after it has been corrupted by the noise in the channel. The task of selecting the correct transmitted signal in the presence of noise is typically accomplished by correlation of the received signal with the set $\{S_i(t)\}$ of M possible signals.

To optimize the process of correlation, the signal set should possess the property known as orthogonality. Orthogonality implies that the functions contained in the signal set $\{S_i(t)\}$ are independent or in disagreement with one another. Two functions $\phi_i(t)$ and $\phi_j(t)$ are said to be orthogonal with one another if

$$\int_0^T \phi_i(t)\phi_j(t)dt = \begin{cases} 1 & \text{for } i = j \\ 0 & \text{elsewhere} \end{cases}$$

Therefore, to optimize the detection process, the signal set $S_i(t)$ is chosen to be a linear combination of N orthonormal, (i.e., unit energy orthogonal) functions such that:

$$S_i(t) = \sum_{j=1}^N a_{ij}\phi_j(t) \quad (\text{EQ. 1})$$

Using the integral operator

$\int_0^T [\dots] \phi_j(t) dt$ on both sides of EQ. 1 yields:

$$\int_0^T S_i(t) \phi_j(t) dt = \int_0^T [\sum a_{ij} \phi_j(t)] \phi_j(t) dt$$

and so:

$$a_{ij} = \int_0^T S_i(t) \phi_j(t) dt = \begin{cases} i = 1, 2, \dots, M \\ j = 1, 2, \dots, N \\ N \leq M \end{cases}$$

Orthogonality will be discussed later in the context of both FH and DS systems.

Frequency Hopping Spread Spectrum (FHSS)

In a frequency hopping system, the carrier is caused to jump around in a pseudorandom fashion under the control of a synthesizer that is driven by a pseudonoise (pn) code generator. Figure 3 illustrates the concept.

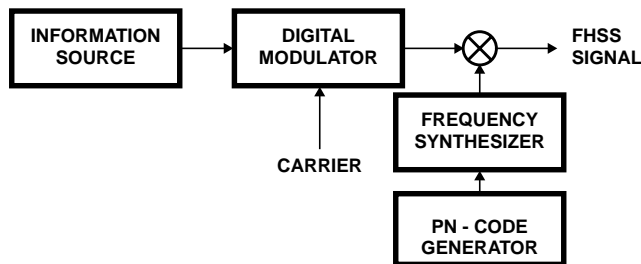

FIGURE 3A. BLOCK DIAGRAM OF A FREQUENCY HOPPING SYSTEM

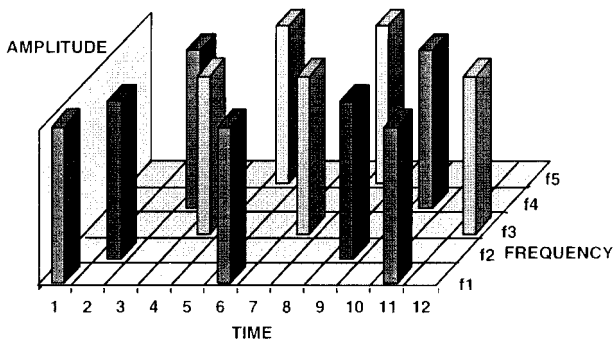

FIGURE 3B. FREQUENCY HOPPING SIGNAL

In Figure 3 the information signal is used by a digital modulator to modulate a carrier signal typically using FSK modulation. The FSK modulated carrier signal is then hopped over a very wide bandwidth compared to the bandwidth of the information signal. The hopping sequence is generated by the pn code generator which sets the synthesizer output. The pn code generator generates what appears to be a random sequence of ones and zeros, but it is not truly random. To understand why, consider the random process of flipping a coin. If we assign a logical one to the occurrence of a head and a logical zero to the occurrence of a tail, then the sequence of ones and zeros produced by flipping a coin is a random process due to the unpredictable fashion in which the sequence is generated. In the case of a pn code generator, a shift register is used to

generate a sequence by the inclusion of a feedback loop which computes a new term for the first stage based on the previous N terms. Because the sequence of ones and zeros generated by the shift register is deterministic and repetitive, the resulting random-like sequence is designated as pseudorandom [6].

We will now investigate in some detail the characteristics and limitations of FH signals in the ISM band of 2400MHz to 2483.5MHz. Since it is difficult for the hopping synthesizer to maintain phase coherence over the wide hopping bandwidth, the FSK waveform is widely used in FH systems because it is relatively easy to demodulate non-coherently. Therefore FSK modulation is assumed throughout the following discussion because of its widespread use in FH systems. An FSK signal can be thought of as the sum of two amplitude shift key (ASK) signals [7]. To see this analogy refer to Figure 4.

In Figures 4A and 4B we have two ASK signals which can be represented mathematically by:

$$ASK_1(t) = \begin{cases} A \cos 2\pi f_1 t + \theta_1 & 0 < t \leq T \\ 0 & \text{elsewhere} \end{cases}$$

$$ASK_2(t) = \begin{cases} A \cos 2\pi f_2 t + \theta_2 & 0 < t \leq T \\ 0 & \text{elsewhere} \end{cases}$$

The FSK waveform of Figure 4C is the linear sum of the two ASK waveforms of Figures 4A and 4B. Thus the FSK waveform is represented mathematically as:

$$FSK(t) = \begin{cases} A \cos 2\pi f_1 t + \theta_1 & \text{For Binary 1} \\ A \cos 2\pi f_2 t + \theta_2 & \text{For Binary 0} \end{cases}$$

$$\text{Where: } f_1 = f_C + f_D \\ f_2 = f_C - f_D$$

As with any FM signal, the bandwidth of the FSK signal depends on the modulation index. Figure 5 shows the typical FSK magnitude spectrum for a carrier frequency f_C and deviation f_D . Having described the FSK waveform graphically and mathematically we now refer to Figure 6 to see the typical spectrum of an ISM band FH signal.

Figure 6A shows ideal line spectra for the 79 hop channels defined by IEEE Std 802.11 for North America and most of Europe. The center frequencies for the 79 channels are defined by IEEE Std 802.11 in 1MHz steps beginning at 2.402GHz and ending at 2.480GHz (see IEEE Std 802.11 for channels and center frequencies in France, Spain, and Japan). This is in compliance with the FCC Part 15 regulation specifying the use of at least 75 hopping frequencies for FHSS systems operating in the 2400MHz to 2483.5MHz band. The minimum hop rate is governed by regulatory authorities and is specified by the FCC in terms of a maximum dwell time of 400ms on any one channel. This equates to a minimum hop rate of 2.5 hops/s. The minimum 802.11 hop is 6MHz for North America and Europe (including France and Spain) and 5MHz minimum for Japan.

Application Note 9820

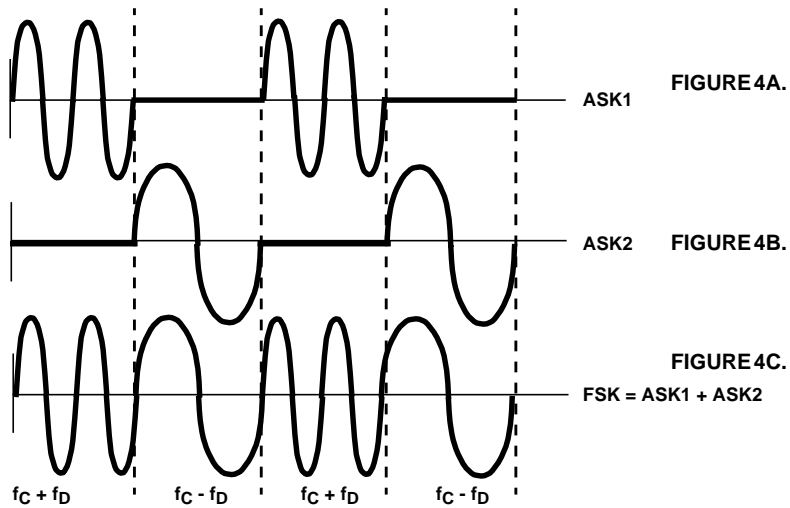

FIGURE 4. FSK WAVEFORM AND ITS ASK COMPONENTS

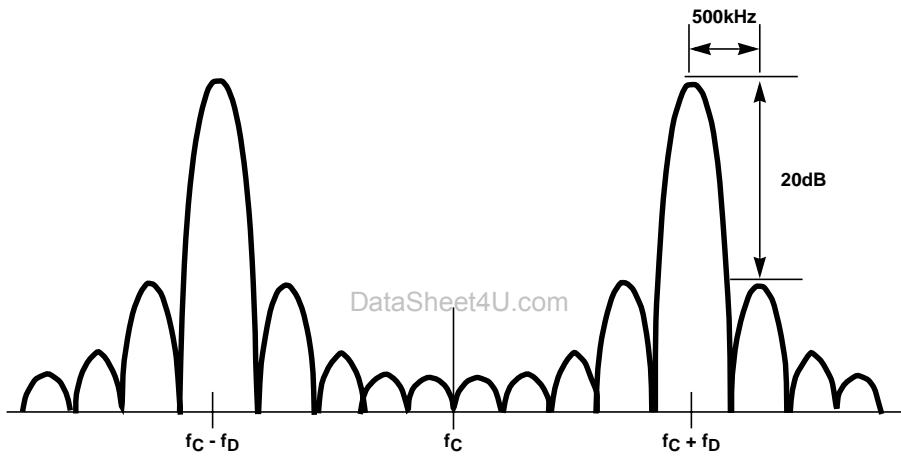

FIGURE 5. FSK MAGNITUDE SPECTRUM [19]

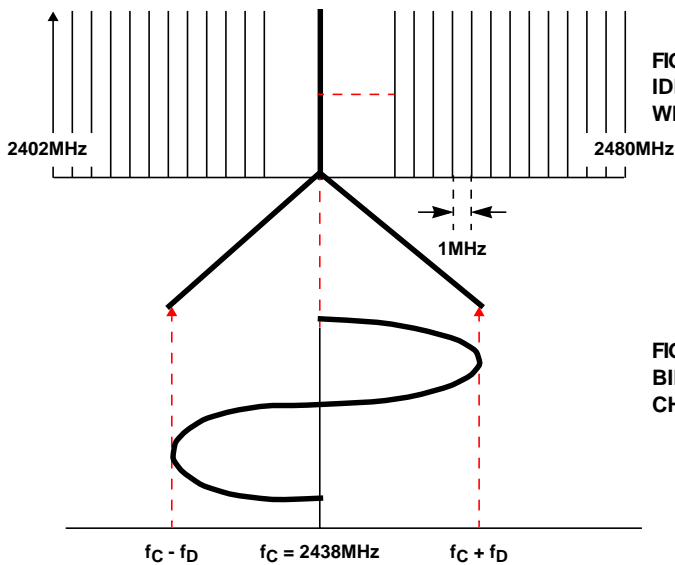

FIGURE 6A.
IDEAL LINE SPECTRA FOR 79 HOP FREQUENCIES
WITHIN THE NORTH AMERICAN ISM BAND

FIGURE 6B.
BINARY FSK MODULATION WITHIN THE HOP
CHANNEL OF 2438MHz

FIGURE 6.

Application Note 9820

In Figure 6B the operating channel at 2438MHz is expanded to show how the carrier is made to deviate for binary frequency shift keying (FSK) modulation. For IEEE Std 802.11 compliant FHSS systems, the carrier deviation is defined for 1Mbps and 2Mbps data rates. Table 2 shows the symbol encoding versus carrier deviations for these systems, along with calculated modulation indices. Given the small modulation indices of Table 2, the FSK spectrum will be narrowband, having at most one significant sidelobe. These systems transmit an entire packet of data on each hop and do not hop in the middle of a packet. While hopping, the carrier is turned off. This method of transmission is known as slow frequency hopping because there are many bits transmitted per hop. In contrast, a fast frequency hopping system has a hopping or chip rate higher than the bit rate.

The time to hop from one channel to another is specified by IEEE Std 802.11 which states that the operating channel center frequency must settle to within $\pm 60\text{kHz}$ of the nominal center frequency in a maximum of $224\mu\text{s}$. Once a hop is completed and the carrier has settled to its nominal frequency for the channel, the FH system must reacquire the 802.11 signal. Consequently, to assist the receiver with acquiring the FH signal the 802.11 FH radio transmitter will send a preamble and header which allows the FH receiver to sync up with the transmitter. Figure 7 shows the composition of an 802.11 FH packet.

TABLE 2. IEEE STD 802.11 CARRIER DEVIATION FOR 1 AND 2Mbps DATA RATES FOR FSK MODULATION

SYMBOL	CARRIER DEVIATION	MODULATION INDEX
1MBIT/S, 2GFSK		
1	$1/2 \times h_2 \times f_{\text{CLK}}$	0.16
0	$-1/2 \times h_2 \times f_{\text{CLK}}$	0.16
2MBIT/S, 4GFSK		
10	$3/2 \times h_4 \times f_{\text{CLK}}$	0.216
11	$1/2 \times h_4 \times f_{\text{CLK}}$	0.072
01	$-1/2 \times h_4 \times f_{\text{CLK}}$	0.072
00	$-3/2 \times h_4 \times f_{\text{CLK}}$	0.216

NOTES:

1. Deviation factor $h_2 = 0.32$ nominal; deviation factor $h_4 = 0.45 \times h_2$.
2. $f_{\text{CLK}} = 1\text{MSymbol/s}$.

Associated with each packet is 128 bits of overhead for synchronization and error checking. Assume it is desired to transmit a large file of 1Mbyte size. Since the 802.11 standard specifies a maximum data packet of 4095 bytes, the FH system must fragment the 1Mbyte file into smaller packets. Typical FH packets are 400 bytes or 3200 bits. Since the preamble and header are always transmitted at 1Mbit/s, another $128\mu\text{s}$ are consumed with reacquiring the FH signal. Thus at 1 MBPS, it takes $3200\mu\text{s} + 128\mu\text{s} \approx 3.33\text{ms}$ to transmit the preamble, header and first packet.

Thus in a 400ms hop dwell, about 124 packets can be transmitted. Together the hopping and reacquisition represent about 3% overhead for large packets. Packets lost due to interference and multipath effects will add to the overhead resulting in lower effective data throughput rates.

Frequency Hopping Collisions

When two FM signals are being broadcast on the same channel we say the two signals interfere with one another. With multiple FH radios we speak of the probability of a collision. A collision occurs when two FH radios hop to the same channel and interfere with each other. The probability of such an event depends upon the number of hopping channels and the number of active, collocated FH radios. Since the dwell time (time spent on any one channel) is typically less than a half a second, a collision or two will go unnoticed. As the number of FH radios increases, collisions become more frequent and effective data throughput is noticeably degraded.

PREAMBLE		HEADER			DATA
SYNC WORD 80 BITS	FRAME TIMING 16 BITS	DATA WORD LENGTH 12 BITS	DATA RATE 4 BITS	ERROR CHECK WORD 16 BITS	DATA 1-4095 BYTES

← 128 BITS →

FIGURE 7. COMPOSITION OF AN IEEE STD 802.11 PACKET

Capacity of an FHSS System

We have now reviewed some of the characteristics of an FHSS system. The foregoing discussion has by no means been exhaustive. The intention was to give the reader a flavor for how FHSS systems work. As a final note on FHSS systems; we will now investigate why FCC regulations practically limit the maximum data rate achievable by an FH system. We begin with a statement of Shannon's Capacity Theorem for a communication channel. The following theorem is taken directly from Shannon's paper "Communication in the Presence of Noise", published in 1949 [12].

Theorem: Let P be the average transmitter power and suppose the noise is white thermal noise of power N in the band W . By sufficiently complicated encoding systems it is possible to transmit binary digits at a rate:

$$C = W \log_2 \frac{P + N}{N}$$

with as small a frequency of errors as desired. It is not possible by any encoding method to send at a higher rate and have an arbitrarily low frequency of errors.

Shannon's expression for channel capacity represents the theoretical upper limit on data rate where arbitrarily small probability of bit error can be achieved with coding [4].

Application Note 9820

In practical systems it is difficult to transmit at or near the capacity limit because the system complexity increases in proportion to the complexity of the coding scheme; and, the randomness of the system noise will tend to limit the number of discrete subdivisions of the signal that can be distinguished reliably.

Let us now consider how the implications of Shannon's capacity theorem place limitations of the signaling speed of an FHSS system. Part 15.247 of the FCC code states that for frequency hopping systems, the maximum 20dB bandwidth of the hopping channel is 1MHz. This means that the FSK sidelobes must be attenuated by 20dB within $\pm 500\text{kHz}$ of the carrier center frequency (see Figure 5).

A well known rule of thumb for the bandwidth of an FM signal is given by Carson's rule [8], which states that:

$$BW = 2[f_D + f_M]$$

where:

BW = bandwidth

f_D = frequency deviation

f_M = frequency of the modulating signal

For a maximum frequency deviation of 0.16MHz and assuming a bit rate of 1Mbit/s, the width of the spectrum generated from the FSK modulation would be:

$$BW = 2[0.16 + 1]\text{MHz}$$

$$BW \cong 2.32\text{MHz}$$

In other words, if Carson's rule held for this case, the information contained in the FSK spectrum would be spread across a 2.32MHz bandwidth. Since the information is contained in the sidelobes, this example shows that the data rate is severely cramped by the available 1MHz bandwidth set by the FCC. In fact, the 1MHz bandwidth set by the FCC is so cramped as to make FSK orthogonal signaling impossible. Here's why. For M-ary FSK signals, the distance between a pair of signals, i.e., the dissimilarity of the signals, is measured by the correlation coefficient gamma (γ) between the two signals. It turns out that for $f_C \gg f_M$, γ has the form of a:

$$\frac{\sin \chi}{\chi}$$

function with the minimum frequency separation between symbols being $1/2T$ for orthogonality where T is the symbol interval (a formal proof of this statement can be found in reference [21]). For an 802.11 FH system, this equates to:

$$\frac{1}{2 \times 10^{-6} \mu\text{s}} = 500\text{kHz}$$

of frequency separation needed for orthogonal signaling. To conserve bandwidth and comply with FCC regulations, the

carrier deviation for an 802.11 FH system is deliberately restricted to a nominal $\pm 160\text{kHz}$. Consequently, since orthogonal signaling is not possible, the FH system will typically use a frequency discriminator to convert the frequency deviations into voltages to demodulate the FSK signal.

We've seen how the restricted bandwidth of the FH system dictates the use of non-orthogonal signaling and small modulation indices. From Shannon's theorem it is evident that bandwidth can be traded for signal power or vice versa. Thus, for a given bandwidth, the information rate can be increased at the expense of higher signal power as measured by E_b/N_0 . In the case of discrete signaling as in FSK, E_b/N_0 is used to compare the relative efficiency of particular communication schemes. Here E_b is the energy per bit in joules, and N_0 is the one-sided noise spectral density in units of watts/Hz.

The expression E_b/N_0 is related to signal-to-noise ratio by the bandwidth utilization efficiency ratio defined as B/R where B is the system bandwidth and R is the bit rate. Thus:

$$S/N = \frac{E_b/N_0}{B/R}$$

Figure 8 shows curves of the Bit Error Rate (BER) versus energy utilization (E_b/N_0) for non-orthogonal 2GFSK and 4GFSK signaling.

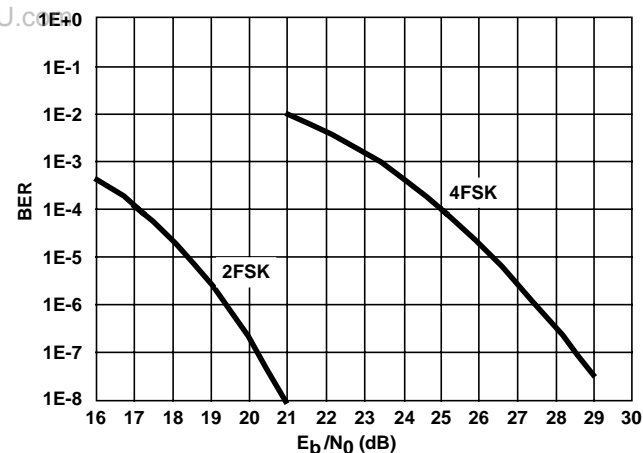

FIGURE 8. PROBABILITY OF BIT ERROR FOR NON-ORTHOGONAL FSK SIGNALING

To achieve higher data rates in a given occupied bandwidth, Shannon said we can encode the data so that a single symbol can represent many bits of data. For binary signaling as in binary FSK, the bit rate and symbol rate are equal. We can double the bit rate by letting one symbol represent a dibit, i.e., two bits. Referring to Figure 8, it can be seen that compared to 2GFSK binary signaling, a 4GFSK system requires a much higher signal strength for a given BER performance, i.e., about 8dB more E_b/N_0 .

Application Note 9820

Thus, for high bit packing coding schemes, the FSK approach becomes impractical due to prohibitively high signal-to-noise ratios required for reliable transmission in the constrained bandwidth allowed. Consequently, despite favorable characteristics such as relatively low complexity and cost, FH systems are not expected to find application in broad horizontal markets such as enterprise computing where Ethernet speeds are the norm.

Direct Sequence Spread Spectrum (DSSS)

Due to non-coherent detection of the FSK waveform, an FHSS radio is less complex and marginally less costly than a DSSS radio. As a result, FHSS systems are found in many vertical market applications where low data rate transmission is palatable. We will now review some of the attributes of DSSS systems and show why direct sequence systems are the logical choice for wireless Ethernet computing.

Like FH, direct sequence spread spectrum (DSSS), also uses a pn code to spread the signal. The term direct sequence spread spectrum is appropriate since with this technique the information signal is directly modulated with a code sequence. The bit rate for the pn sequence is called the chip rate.

The IEEE 802.11 standard specifies the use of Barker codes for the chip sequence used in DSSS systems. Barker codes are named after Ronald H. Barker who first used them as frame sync markers in a matched filter that used digital signals [9]. Barker codes are known to possess good aperiodic correlation properties [10], which simply means that due to the non-repetitive behavior of the code a matched filter correlator can easily identify the location of a Barker code in a sequence of bits. The same properties that make Barker codes good frame sync markers also make them good pn codes for spreading and despreading DS signals.

Table 3 contains the complete listing of all known Barker codes [9, 10].

TABLE 3. LISTING OF KNOWN BARKER CODES

CODE LENGTH (N)	BARKER SEQUENCE
1	+
2	++ or +-
3	++-
4	+++ - or ++ - +
5	++++ - +
7	++++ - - - +
11	++++ - - - + - - - +
13	++++ + - - - + - - - +

As Table 3 shows, the list of known Barker codes is limited to eight sequences. Due to their relatively short length, Barker codes are convenient when fast pn code synchronization is a requirement. Other coding schemes are available when longer codes are needed. The Barker sequence for code length $N = 11$ is used to spread an IEEE 802.11 DSSS waveform. The $N = 11$ code changes phase 6 times for one symbol which means the carrier changes

phase six times for a single symbol. The Intersil PRISM radio of Figure 2 uses a simple exclusive OR (XOR) gate to mix the pn sequence with differential PSK encoded digital data as shown in Figure 9.

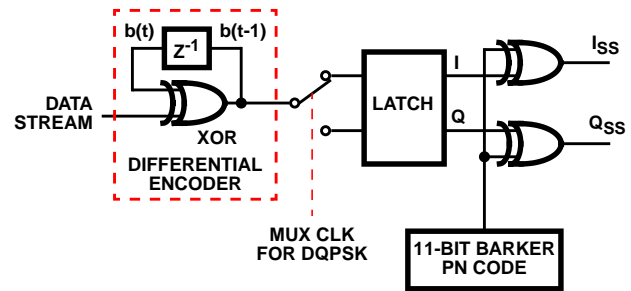

FIGURE 9. PRISM RADIO DIFFERENTIAL ENCODER AND PN CODE SPREADING CIRCUIT

The XOR function performs what is called modulo-2 addition on the digital data stream. Recall from basic computer logic that the XOR function has the truth table of Table 4.

TABLE 4. TRUTH TABLE FOR XOR FUNCTION

a	b	f(a,b)
0	0	0
0	1	1
1	0	1
1	1	0

The effect of the modulo-2 addition is to invert the pn code on each transition of the data bit stream and spread the bandwidth of the information signal. The timing diagram of Figure 10 illustrates the effect of modulo-2 addition by the pn code. A time invariant matched filter correlator in the receive section of the HFA3860B is used to despread the DPSK signal. The time invariant property means that a time shift at the correlator input results in the same time shift at its output.

Differential Encoding

Notice the differential PSK encoder of Figure 9. Since IEEE Std 802.11 specifies DPSK modulation for DSSS systems, the raw baseband data is differentially encoded in the transmitter for subsequent demodulation by a differential decoder in the receiver. With DPSK modulation, the information is conveyed by the phase difference between adjacent signal elements of the transmitted signal. Thus it is not necessary to have a coherent phase reference in the receiver to demodulate a DPSK signal. The trade-off for the reduced system complexity of differential PSK is a higher bit error rate (BER) for a given signal-to-noise ratio because the noise perturbs the phase reference along with the information signal. The HFA3860B baseband processor of Figure 1 uses coherent demodulation of the data for improved BER performance of the differentially encoded signals. Figure 11 shows the BER performance curve for the PSK modes of the baseband processor. From Figure 11, we see that for 1Mbit/s data rate, an E_b/N_0 of about 11.5dB is needed for a bit error rate of 10^{-4} bit-error/s.

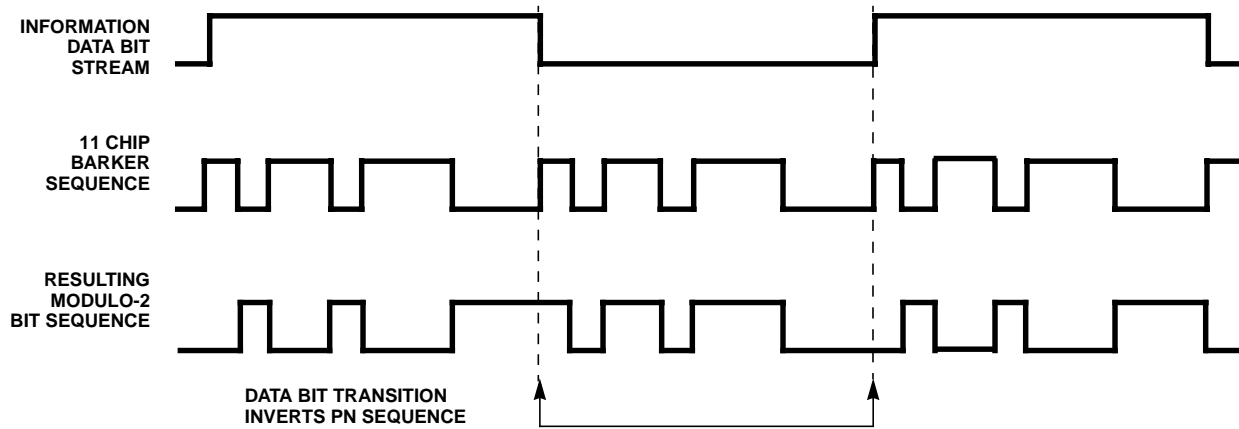

FIGURE 10. RESULTING WAVEFORM OF MODULO-2 ADDITION OF INFORMATION BIT

Processing Gain and Jamming Margin

Now that we've seen how the encoded DSSS signal is directly modulated by the PN code generator, let's consider the effect of this modulation.

Figure 12 shows the typical power spectrum of a DSSS signal before and after spreading. Notice that the spectrum has the shape of an envelope expressed as:

$$\left(\frac{\sin x}{x}\right)^2$$

The direct modulation (modulo-2 addition of the pn sequence with the encoded baseband signal) effectively spreads the signal over a much wider bandwidth. The main lobe bandwidth of Figure 12 is a function of the modulation waveshape and code rate. A general rule of thumb for DSSS systems is that the null to null bandwidth is 2X the chip rate. Thus using an 11-bit Barker code at a chip rate of 11 Mcps the null to null bandwidth of the spread signal is 22MHz. This allows for three non-overlapping DSSS channels in the ISM band.

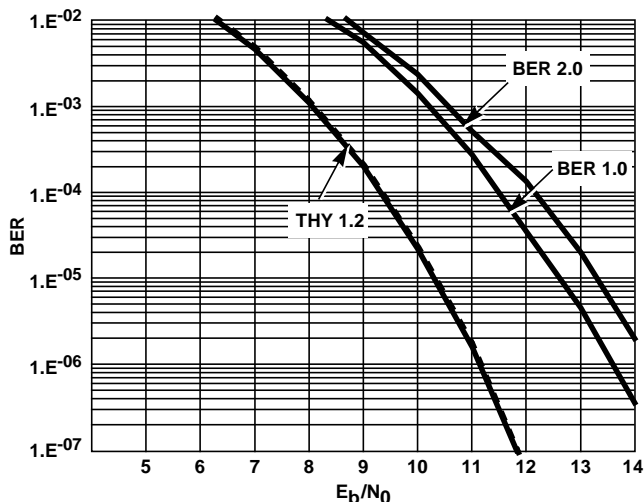

FIGURE 11. BER vs Eb/N0 PERFORMANCE FOR PSK MODES

In the receiver the spread signal is again modulo-2 added to the pn sequence. This effectively collapses the spread signal to its original bandwidth and amplitude while simultaneously spreading any noise or unwanted interfering signals. A bandpass filter can then reject most of the unwanted signal and noise power. It is this spreading/despreading mechanism by which processing gain is achieved in a DSSS system. Processing gain is an important figure of merit used for DSSS systems and is readily determined by Equation 2:

$$\text{Processing Gain} = G_P = \frac{BW(ss)}{R_{(INFO)}} \quad (\text{EQ. 2})$$

where:

BW(ss) is the bandwidth after spreading and $R_{(INFO)}$ is the baseband information data rate. Applying Equation 2 to the HFA3860B 2Mbit/s mode, we obtain a processing gain of:

$$G_P(\text{dB}) = 10 \log \frac{22\text{MHz}}{2\text{Mbits/s}} = 10.4\text{dB}$$

Although processing gain as defined in Equation 2 is a useful figure of merit and is easily obtainable, it does not tell the whole story. Another figure of merit called jamming margin takes into account internal system losses and the signal to noise ratio as measured at the demodulated output of the receiver. The FCC uses the CW jamming margin method for measuring processing gain and requires that DSSS transmitters have a processing gain of at least 10dB as measured by this method.

For FCC purposes the processing gain is calculated from Equation 3:

$$G_P = (S/N)_0 + M_J + L_{SYS} \quad (\text{EQ. 3})$$

Where:

$(S/N)_0$ is the theoretical signal to noise ratio required to maintain normal operation relative to a nominal bit error rate.

M_J is the maximum jammer-to-signal ratio at the detected BER; also known as jamming margin.

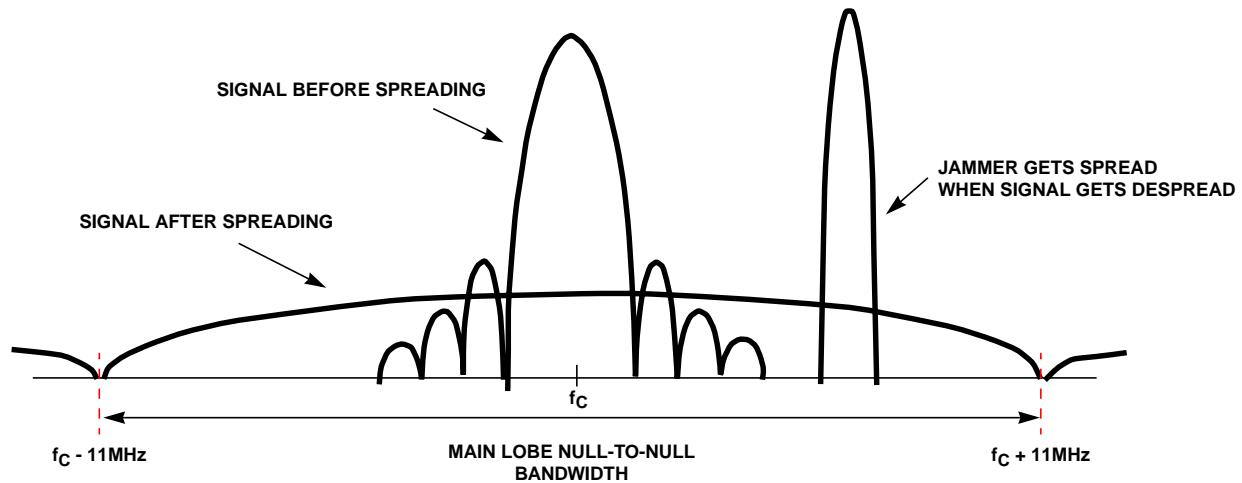

FIGURE 12. POWER SPECTRUM OF DSSS BEFORE AND AFTER SPREADING

L_{SYS} are cumulative systems losses due to filtering, synchronization, tracking, etc.

We can solve Equation 3 for the jamming margin M_J as follows:

$$M_J = G_P - (S/N)_0 - L_{SYS} \quad (\text{EQ. 4})$$

Now, given a BPSK signal with $(S/N)_0 = 9.6\text{dB}$ and $L_{SYS} = 2\text{dB}$ and assuming the minimum allowed G_P of 10dB , Equation 3 yields a system jamming margin of -1.6dB . Consequently, we would not expect the system to operate reliably with an interfering signal more than -1.6dB above the desired data signal. This is the meaning of the system jamming margin.

Choice of MBOK Modulation

The selection of a particular modulation technique involves making trade-offs among various constraints and conflicting goals. The communications engineer generally will attempt to:

- Maximize spectral efficiency (bits/Hz)
- Minimize power required
- Maximize system utilization
- Minimize system cost

Trading off among these four criteria was indeed the case in choosing MBOK modulation for the high data rate radio of Figure 2. First of all, it was desired that the high rate radio be backward compatible with the IEEE Std 802.11 basic access and enhanced access rates of 1Mbit/s and 2Mbit/s . Thus the radio had to be capable of using the 802.11 preamble and header for signal acquisition and then do on the fly rate switching to the high data rate. Conveniently, the 802.11 protocol already accommodates rate changing. On the fly rate switching offers the added benefit of allowing the radio to downshift to lower, more robust data rates in high multipath environments such as might be found in large open areas like a supermarket, or factory floor.

To maximize system utilization it was desired to keep the spread rate the same as that for 802.11 in order to maintain at least three non-overlapping channels in the band. This is the minimum necessary for co-located networks because it allows for frequency reuse. Figures 13A and 13B illustrate the concept of frequency reuse in co-located networks.

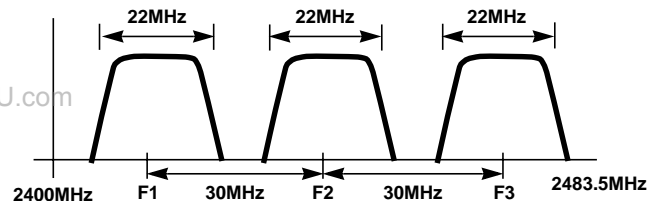

FIGURE 13A. ILLUSTRATION OF NON-OVERLAPPING CHANNELS IN THE ISM BAND

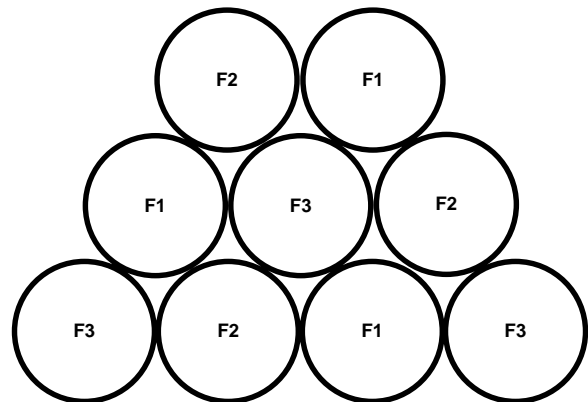

FIGURE 13B. ILLUSTRATION OF FREQUENCY REUSE FOR CELL PLANNING

Figure 13A shows three DSSS channels occupying the ISM band. In Figure 13B we see how having a minimum of three channels in the band allows the network planner to implement a cellular network via frequency reuse. Each adjacent cell is assigned a different channel and therefore interference between adjacent cells is minimized for the

Application Note 9820

two dimensional network of Figure 13B. This is the same concept used in cellular phone networks. Of course adding more channels within the ISM band would allow for increased system utilization by allowing the network planner to fit more users per unit area in smaller cells. The drawback of adding more channels is we must contend with Shannon's capacity law. By narrowing the channel bandwidth in order to put more channels within the ISM band, we reduce channel capacity. In this case it was desired to increase the data rate by a factor of at least 10 over the basic access rate so decreasing the channel bandwidth conflicted with this goal. In addition, a bandwidth reduction would make it difficult or impossible to meet the 10dB processing gain requirement of the FCC since processing gain is related to the spread rate. Due to the above considerations a search was conducted for a modulation technique that:

- Was energy efficient, i.e., had a high signal energy per bit per hertz.
- Would allow for a minimum of three non-overlapping channels in the ISM band.
- Could achieve high data throughput rates through efficient coding.

After running simulations on a number of candidate waveforms, MBOK modulation was chosen as offering the best combination of necessary characteristics for meeting all of the above requirements while minimizing system complexity and cost.

Walsh Functions

It was stated earlier that orthogonal signaling could be used to optimize the detection process in a digital communications system. That is, a detector can be designed that makes the fewest errors on average if the signal set possesses the orthogonality property.

A class of functions that has true orthogonality are the Walsh functions. Walsh functions have been known since 1923 and are advantageous because they assume only values of ± 1 and therefore are easily generated by digital circuits. An XOR gate can be used to modulate a baseband information bit with a Walsh function. It turns out that a Walsh function is simply a row or column taken from a Hademard matrix. A Hademard matrix is a symmetric, square matrix composed of ones and zeros, with a dimension that is a power of two.

Hademard matrices are defined recursively by:

$$H_{n+1} = \begin{vmatrix} H_n & H_n \\ H_n & \overline{H_n} \end{vmatrix}$$

Let's see how to build a set of 8-bit Walsh functions from Hademard matrices.

First take the H_1 matrix where:

$$H_1 = \begin{vmatrix} 0 & 0 \\ 0 & 1 \end{vmatrix}$$

By definition:

$$H_2 = \begin{vmatrix} H_1 & H_1 \\ H_1 & \overline{H_1} \end{vmatrix} = \begin{vmatrix} 0 & 0 & 0 & 0 \\ 0 & 1 & 0 & 1 \\ \hline 0 & 0 & 1 & 1 \\ 0 & 1 & 1 & 0 \end{vmatrix}$$

Similarly:

$$H_3 = \begin{vmatrix} H_2 & H_2 \\ H_2 & \overline{H_2} \end{vmatrix} = \begin{vmatrix} 0 & 0 & 0 & 0 & 0 & 0 & 0 & 0 \\ 0 & 1 & 0 & 1 & 0 & 1 & 0 & 1 \\ 0 & 0 & 1 & 1 & 0 & 0 & 1 & 1 \\ 0 & 1 & 1 & 0 & 0 & 1 & 1 & 0 \\ \hline 0 & 0 & 0 & 0 & 1 & 1 & 1 & 1 \\ 0 & 1 & 0 & 1 & 1 & 0 & 1 & 0 \\ 0 & 0 & 1 & 1 & 1 & 1 & 0 & 0 \\ 0 & 1 & 1 & 0 & 1 & 0 & 0 & 1 \end{vmatrix}$$

Notice in our 8x8 Hademard matrix that any two rows or columns are mutually orthogonal, that is, for any two rows the number of columns in which they agree is equal to the number of columns in which they disagree. Similarly, pick any two columns and the number of rows in which they agree is equal to the number of rows in which they disagree. Matrix H_3 represents a set of eight Walsh functions. We can use these functions as the pn codes used for spreading a baseband information signal and because of orthogonality, detection at the receiver can be optimized.

MBOK Implementation in the Baseband Processor

For the purpose this discussion the 11Mbit/s mode (QMBOK) is described. Refer to the HFA3860B [15] data sheet (AnswerFAX Doc. #4488) for a description of the 5.5Mbit/s mode. We have seen how a Hademard matrix is used to generate a set of orthogonal code words called Walsh functions. Now let's see how a digital encoder in the HFA3860B uses these functions to modulate the input data stream (see Note 3). First of all the eight orthogonal Walsh functions are stored in the correlator banks, for I and Q. As the serial data stream comes into the baseband processor it is partitioned into 4-bit nibbles. Two 4-bit nibbles are used in the 11Mbit/s mode, one for the I channel and one for the Q channel. Each nibble for the I and Q channels is partitioned into 3 bits of magnitude and 1 bit of sign data. The 3 magnitude bits in the I and Q channels independently select one-of-eight 8-bit Walsh functions.

NOTE:

3. The actual Walsh functions used in the HFA3860B are modified to insure no all zero member. See the HFA3860B data sheet for details.

The sign bits are modulo-2 added to the 8-bit Walsh functions in the I and Q channels. Modulo-2 addition by the

sign bit is the nature of biorthogonal signaling. With biorthogonal signals there are two sets of $M/2$ mutually orthogonal signals, but the two sets are not mutually orthogonal; instead they are antipodal to one another. You are already familiar with antipodal signaling as it is the type used in the BPSK and QPSK modulations for the 1Mbit/s and 2Mbit/s modes of the HFA3860B. Thus modulo-2 addition by the sign bit generates two sets of antipodal signals for the I channel and the Q channel. The signals within each set are mutually orthogonal.

We have now seen how 8 bits of data are encoded into a single symbol in the HFA3860B. The chipping rate for the 8-bit Walsh functions is 11Mchip/s in order to keep the spread bandwidth the same as that for the 1Mbit/s and 2Mbit/s modes. Thus in the same occupied bandwidth the QMBOK modulation packs 5.5 times as much data as the QPSK modulation.

Since the Walsh functions are 8 bits in length and the chipping rate is 11Mchip/s, the symbol rate is 1.375MS/s, i.e.,

$11\text{Mbit/s} \div 8 \text{ bits/symbol} = 1.375\text{MS/s}$. Figure 14 depicts a constellation diagram for the QMBOK waveform.

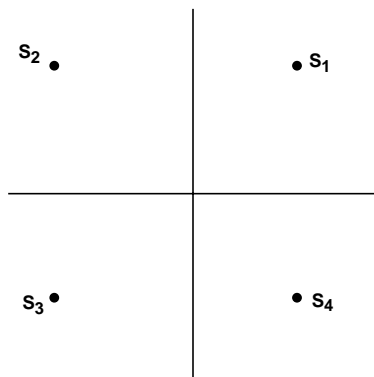

FIGURE 14. CONSTELLATION DIAGRAM FOR MBOK SIGNALLING

In a similar fashion the BMBOK mode (5.5Mbit/s) packs 5.5 times as much data into a symbol as the BPSK modulation of the 1Mbit/s mode. At this point an astute reader might ask the question: given that the FCC requires a minimum processing gain of 10dB, how does the MBOK waveform meet the FCC requirement with an 8-bit Walsh spreading function?

The answer to this question lays in the fact that the MBOK waveform possesses two types of gain, i.e., processing gain and coding gain. We have already reviewed processing gain. Coding gain arises from the fact that MBOK modulation has about 1.6dB better E_b/N_0 performance than BPSK modulation. In other words, the signal-to-noise ratio per bit necessary to make a symbol decision is about 1.6dB lower than that necessary to make individual bit decisions. Together the inherent MBOK coding gain and processing gain add up to exceed the FCC 10dB requirement.

Detection of the MBOK Signal

The transmitter generates the MBOK signal and imposes the waveform on the channel. At the other end of the channel the receiver must detect the signal. Now let's see how the correlator in the receiver uses the orthogonality property of the signal set to detect the correct signal. Since there are eight Walsh functions (and their inverses), a bank of sixteen correlators, eight each for the I and Q channels are used to detect which signal was sent by matching or correlating the Walsh functions to the received signal. Figure 15 is a block diagram of the process.

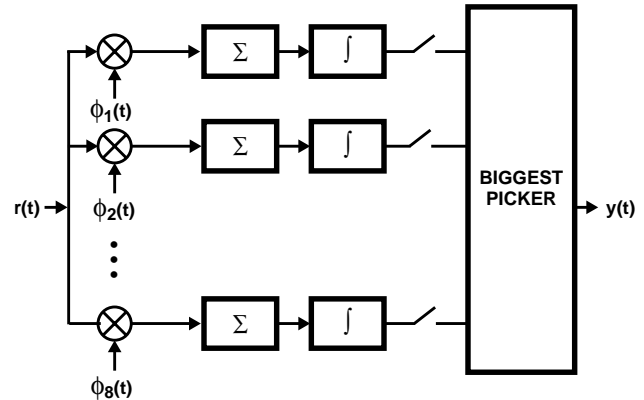

FIGURE 15. BLOCK DIAGRAM OF RECEIVER CORRELATOR FUNCTION

The correlators are of a multiply-accumulate architecture. As the serial data corrupted by noise enters each correlator it is multiplied by the Walsh functions and added to the accumulator. The correlator outputs are integrated over the symbol period, sampled and dumped to a "select the largest" or "biggest picker" circuit. The output of the correlator with the correct Walsh function will peak in response to the signal. The outputs of the other correlators do not peak so the receiver knows which signal was transmitted. Thus, the output of the i th correlator is:

$$y(t) = \int_0^T r(t)\phi_i(t)dt$$

where $r(t) = s_i(t) + n(t)$ consequently

$$y(t) = \int_0^T \{S_i(t) + n(t)\}\phi_i(t)dt$$

$$y(t) = \int_0^T S_i(t)\phi_i(t)dt + \int_0^T n(t)\phi_i(t)dt$$

since $n(t)$ is uncorrelated with the Walsh function, its integration with it is low and we are left with the integral of the transmitted signal multiplied with the Walsh function.

Application Note 9820

MBOK System Complexity and Cost

The 11Mbit/s radio of Figure 2 has the same number of components, and fits on the same PCMCIA card as Intersil's existing 2Mbit/s PRISM radio. The HFA3860B baseband processor has the same footprint as that for the HFA3824 2Mbit/s baseband processor so both processors fit in the same 48 Lead TQFP package. For a 5.5X increase in data rate performance the cost penalty for the overall radio of Figure 2 is modest when compared to a 2Mbit/s radio.

Conclusions

An efficient modulation technique known as MBOK has been described for wireless data transmission. It has been shown that when used in a direct sequence spread spectrum radio the MBOK modulation technique is capable of achieving:

- Ethernet data rates
- Greater than 10dB of processing gain
- Three non-overlapping channels in the ISM band.
- Relatively low system complexity and cost.

Such radios have been certified by the FCC for operation in the ISM band. It was shown why frequency hopping radios operating in the ISM band will have difficulty achieving Ethernet speed due to the limited bandwidth of the FSK waveform. This application note has by no means been an all inclusive treatise on the subject of spread spectrum communications. Important subjects like carrier tracking, symbol timing synchronization and multipath effects were not covered. The interested reader can refer to the References for more information on this broad subject.

References

For Intersil documents available on the internet, see web site <http://www.intersil.com/>
Intersil AnswerFAX (321) 724-7800.

- [1] 47 Code of Federal Regulations, Part 15.
- [2] IEEE Std 802.11, *Wireless LAN Medium Access Control (MAC) and Physical Layer (PHY) Specifications*, Institute of Electrical and Electronic Engineers, November, 1997.
- [3] Dixon, Robert C., *Spread Spectrum Systems with Commercial Applications*, 3rd Edition, John Wiley & Sons, Inc., copyright 1994.
- [4] Simon, Marion K., Omura, Jim K., Scholtz, Robert A., Levitt, Barry K., *Spread Spectrum Communications Handbook*, McGraw-Hill Co. Copyright 1994.
- [5] Scientific American magazine, April 1998, pp 95.
- [6] Utlaut, William F., *Spread Spectrum, Principles and Possible Application to Spectrum Utilization and Application*, IEEE Communication Society Magazine, September 1978.
- [7] Stremler, Ferrel G., *Introduction to Communication Systems*, 2nd Edition, Addison-Wesley Publishing Company, copyright 1982.
- [8] Frenzel, Louis E., *Principles of Electronic Communications Systems*, Glencoe, McGraw-Hill, copyright 1998.
- [9] Spilker, James J., Jr., *Digital Communications by Satellite*, Prentice-Hall, copyright 1977.
- [10] Ziemer, R. E. and Tranter W.H., *Principles of Communications, Systems, Modulation, and Noise*, John Wiley & Sons, copyright 1995.
- [11] Panter, Philip F., *Modulation, Noise and Spectral Analysis Applied to Information Transmission*, McGraw-Hill, copyright 1965.
- [12] Shannon, Claude E., *Communications in the Presence of Noise*, Proceedings of the IRE, Vol. 37, pp. 10-21, Jan. 1949.
- [13] Andren, Carl, *11Mb/s Modulation Techniques*, Proceedings of the Sixth Annual Wireless Symposium, Penton Publishing, copyright 1998.
- [14] Andren, Carl, *A 2.4GHz, 11Mb/s Baseband Processor for 802.11 Applications*, Proceedings of the Sixth Annual Wireless Symposium, Penton Publishing, copyright 1998.
- [15] Intersil Corporation, *HFA3860B Data Sheet*, AnswerFAX Document #4488.
- [16] Couch, Leon W. II, *Modern Communications Systems, Principles and Applications*, Prentice-Hall, copyright 1995.
- [17] Schumacher, Paul M., *Understanding the Basics of Spread-Spectrum Communications*, Part 1, Microwaves and RF magazine, May 1993.
- [18] Fakatselis, J. and Petrick, A., *System Considerations in Spread-Spectrum Designs*, Wireless Design and Development magazine, April 1995, Volume 3, Number 4.
- [19] Stremler, Ferrel G., *Introduction to Communication Systems*, 2nd Edition, Addison-Wesley Publishing Co. copyright 1982.
- [20] Cooper, G. R. and McGillen, C. D., *Modern Communications and Spread Spectrum*, McGraw-Hill, copyright 1985.
- [21] Proakis, John G., and Salehi, Masoud, *Communications Systems Engineering*, Prentice Hall, copyright 1994.

All Intersil products are manufactured, assembled and tested utilizing ISO9000 quality systems.
Intersil Corporation's quality certifications can be viewed at website www.intersil.com/quality/iso.asp.

Intersil products are sold by description only. Intersil Corporation reserves the right to make changes in circuit design and/or specifications at any time without notice. Accordingly, the reader is cautioned to verify that data sheets are current before placing orders. Information furnished by Intersil is believed to be accurate and reliable. However, no responsibility is assumed by Intersil or its subsidiaries for its use; nor for any infringements of patents or other rights of third parties which may result from its use. No license is granted by implication or otherwise under any patent or patent rights of Intersil or its subsidiaries.

For information regarding Intersil Corporation and its products, see web site www.intersil.com www.DataSheet4U.com