

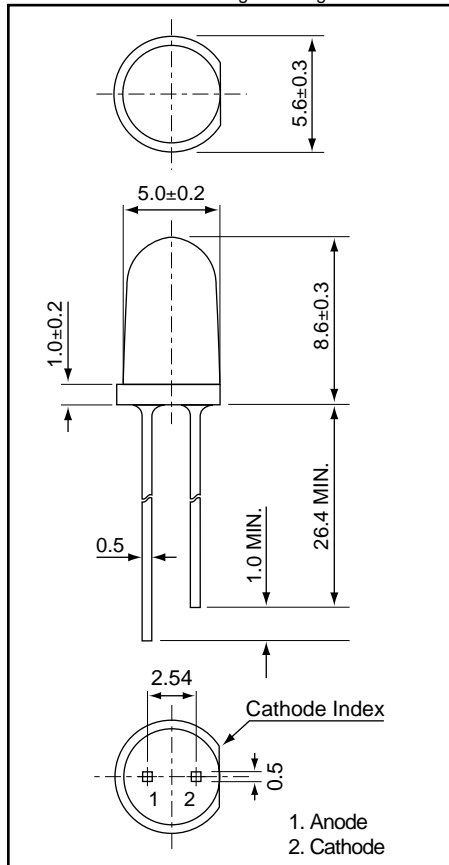

Weight: 0.31 g Unit: mm



AND180CRP

GaAIAs Red Light Emission

T-1 3/4 Package (5 mm)

Features

- Peak wavelength ($\lambda_p = 660$ nm) high bright emission
- All plastic mold type, clear colorless lens
- Low drive current: 20 mA for outdoor applications
0.5 mA for indoor applications
- Excellent On-Off contrast ratio
- Fast response time, capable of pulse operation
- Suitable for Outdoor Message Signboards

Maximum Ratings ($T_a = 25^\circ\text{C}$)

Characteristics	Symbol	Rating	Unit
Forward Current	I_F	40	mA
Reverse Voltage	V_R	5	V
Power Dissipation	P_D	125	mW
Operating Temperature Range	T_{Opr}	-40 to 85	$^\circ\text{C}$
Storage Temperature Range	T_{Stg}	-40 to 100	$^\circ\text{C}$

Electro-Optical Characteristics ($T_a = 25^\circ\text{C}$)

Characteristics	Symbol	Test Condition	Minimum	Typical	Maximum	Unit
Forward Voltage	V_F	$I_F = 20$ mA	–	1.7	2.4	V
Reverse Current	I_R	$V_R = 4$ V	–	–	10	μA
Luminous Intensity	I_V	$I_F = 20$ mA	2,500	3,600	–	mcd
Peak Emission Wavelength	λ_p	$I_F = 20$ mA	–	660	–	nm
Spectral Line Half Width	$\Delta\lambda$	$I_F = 20$ mA	–	20	–	nm
Dominant Wavelength	λ_d	$I_F = 20$ mA	–	643	–	nm
Full Viewing Angle	θ	$I_V = 1/2$ Peak	–	10	–	degree

Precaution

Please be careful of the following:

1. Soldering temperature: 260°C max
Soldering time: 5 sec. max
Soldering portion of lead: up to 1.6 mm from the body of the device
2. The lead can be formed up to 5 mm from the body of the device without forming stress.
Soldering should be performed after the lead forming.

