

General Description

The AO4478 uses advanced trench technology to provide excellent $R_{DS(ON)}$, low gate charge. This device is suitable for use as general purpose, PWM and a load switch applications.

Product Summary

V_{DS} (V) = 30V
 I_D = 9A (V_{GS} = 10V)
 $R_{DS(ON)}$ < 19m Ω (V_{GS} = 10V)
 $R_{DS(ON)}$ < 26m Ω (V_{GS} = 4.5V)

100% UIS Tested
 100% Rg Tested



SOIC-8

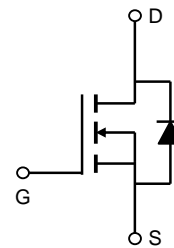
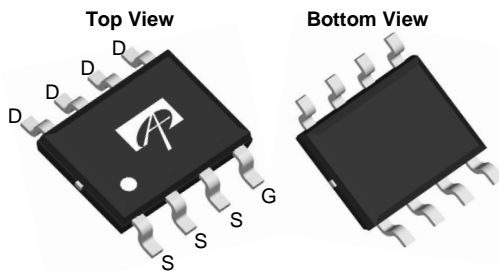

Absolute Maximum Ratings $T_A=25^\circ\text{C}$ unless otherwise noted

Parameter	Symbol	Maximum	Units
Drain-Source Voltage	V_{DS}	30	V
Gate-Source Voltage	V_{GS}	± 25	V
Continuous Drain Current	I_D	$T_A=25^\circ\text{C}$	A
		$T_A=70^\circ\text{C}$	
Pulsed Drain Current ^C	I_{DM}	60	A
Avalanche Current ^C	I_{AR}	17	
Repetitive avalanche energy $L=0.1\text{mH}^C$	E_{AR}	14	mJ
Power Dissipation ^B	P_D	$T_A=25^\circ\text{C}$	W
		$T_A=70^\circ\text{C}$	
Junction and Storage Temperature Range	T_J, T_{STG}	-55 to 150	$^\circ\text{C}$

Thermal Characteristics

Parameter	Symbol	Typ	Max	Units
Maximum Junction-to-Ambient ^A	$R_{\theta JA}$	31	40	$^\circ\text{C/W}$
Maximum Junction-to-Ambient ^{AD}		Steady-State	59	75
Maximum Junction-to-Lead ^C	$R_{\theta JL}$	16	24	$^\circ\text{C/W}$

Electrical Characteristics ($T_J=25^\circ\text{C}$ unless otherwise noted)

Symbol	Parameter	Conditions	Min	Typ	Max	Units
STATIC PARAMETERS						
BV_{DSS}	Drain-Source Breakdown Voltage	$I_D=250\mu\text{A}, V_{GS}=0\text{V}$	30			V
I_{DSS}	Zero Gate Voltage Drain Current	$V_{DS}=30\text{V}, V_{GS}=0\text{V}$ $T_J=55^\circ\text{C}$			1 5	μA
I_{GSS}	Gate-Body leakage current	$V_{DS}=0\text{V}, V_{GS}=\pm 25\text{V}$			100	nA
$V_{GS(th)}$	Gate Threshold Voltage	$V_{DS}=V_{GS}, I_D=250\mu\text{A}$	1	1.6	2	V
$I_{D(ON)}$	On state drain current	$V_{GS}=10\text{V}, V_{DS}=5\text{V}$	60			A
$R_{DS(ON)}$	Static Drain-Source On-Resistance	$V_{GS}=10\text{V}, I_D=9\text{A}$ $T_J=125^\circ\text{C}$		16 25	19 30	$\text{m}\Omega$
		$V_{GS}=4.5\text{V}, I_D=8\text{A}$		21	26	$\text{m}\Omega$
g_{FS}	Forward Transconductance	$V_{DS}=5\text{V}, I_D=10\text{A}$		24		S
V_{SD}	Diode Forward Voltage	$I_S=1\text{A}, V_{GS}=0\text{V}$		0.70	1	V
I_S	Maximum Body-Diode Continuous Current				4	A
DYNAMIC PARAMETERS						
C_{iss}	Input Capacitance	$V_{GS}=0\text{V}, V_{DS}=15\text{V}, f=1\text{MHz}$		466	560	pF
C_{oss}	Output Capacitance			90		pF
C_{rss}	Reverse Transfer Capacitance			61		pF
R_g	Gate resistance	$V_{GS}=0\text{V}, V_{DS}=0\text{V}, f=1\text{MHz}$		3.7	5.6	Ω
SWITCHING PARAMETERS						
$Q_g(10\text{V})$	Total Gate Charge	$V_{GS}=10\text{V}, V_{DS}=15\text{V}, I_D=9\text{A}$		9.3	11	nC
$Q_g(4.5\text{V})$	Total Gate Charge			4.3	5.2	nC
Q_{gs}	Gate Source Charge			1		nC
Q_{gd}	Gate Drain Charge			2.3		nC
$t_{D(on)}$	Turn-On DelayTime	$V_{GS}=10\text{V}, V_{DS}=15\text{V}, R_L=1.65\Omega,$ $R_{GEN}=3\Omega$		5		ns
t_r	Turn-On Rise Time			8		ns
$t_{D(off)}$	Turn-Off DelayTime			20		ns
t_f	Turn-Off Fall Time			5		ns
t_{rr}	Body Diode Reverse Recovery Time	$I_F=9\text{A}, di/dt=500\text{A}/\mu\text{s}$		7.5	9	ns
Q_{rr}	Body Diode Reverse Recovery Charge	$I_F=9\text{A}, di/dt=500\text{A}/\mu\text{s}$		9.8		nC

A. The value of $R_{\theta JA}$ is measured with the device mounted on 1in² FR-4 board with 2oz. Copper, in a still air environment with $T_A=25^\circ\text{C}$. The value in any given application depends on the user's specific board design.

B. The power dissipation P_D is based on $T_{J(MAX)}=150^\circ\text{C}$, using $\leq 10\text{s}$ junction-to-ambient thermal resistance.

C. Ratings are based on low frequency and duty cycles to keep initial $T_J=25^\circ\text{C}$.

D. The $R_{\theta JA}$ is the sum of the thermal impedance from junction to lead $R_{\theta JL}$ and lead to ambient.

E. The static characteristics in Figures 1 to 6 are obtained using $<300\mu\text{s}$ pulses, duty cycle 0.5% max.

F. These curves are based on the junction-to-ambient thermal impedance which is measured with the device mounted on 1in² FR-4 board with 2oz. Copper, assuming a maximum junction temperature of $T_{J(MAX)}=150^\circ\text{C}$. The SOA curve provides a single pulse rating.

Rev1: Nov. 2010

THIS PRODUCT HAS BEEN DESIGNED AND QUALIFIED FOR THE CONSUMER MARKET. APPLICATIONS OR USES AS CRITICAL COMPONENTS IN LIFE SUPPORT DEVICES OR SYSTEMS ARE NOT AUTHORIZED. AOS DOES NOT ASSUME ANY LIABILITY ARISING OUT OF SUCH APPLICATIONS OR USES OF ITS PRODUCTS. AOS RESERVES THE RIGHT TO IMPROVE PRODUCT DESIGN, FUNCTIONS AND RELIABILITY WITHOUT NOTICE.

TYPICAL ELECTRICAL AND THERMAL CHARACTERISTICS

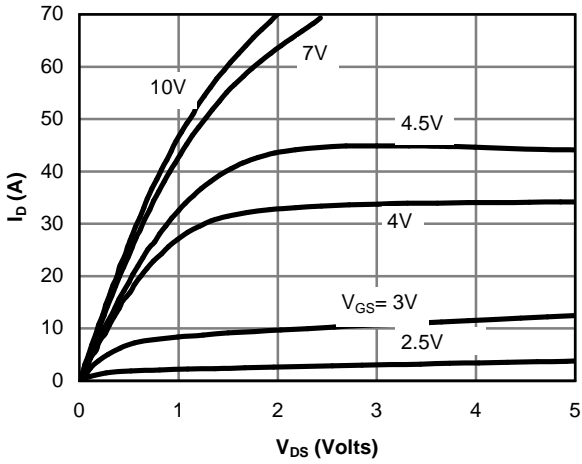

Figure 1: On-Region Characteristics(Note E)

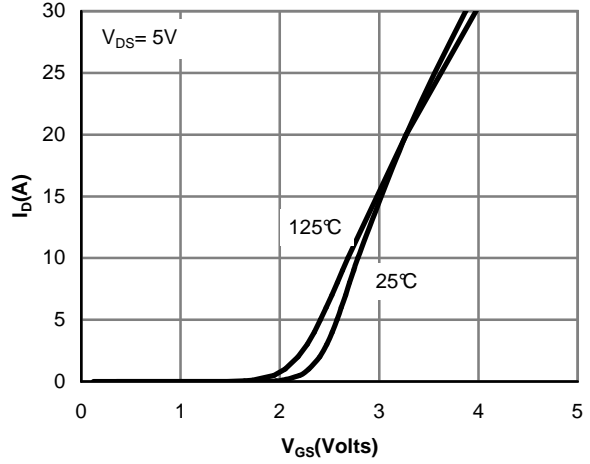

Figure 2: Transfer Characteristics(Note E)

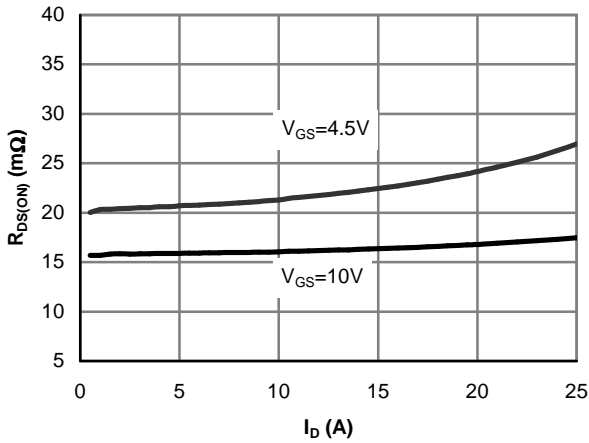

Figure 3: On-Resistance vs. Drain Current and Gate Voltage(Note E)

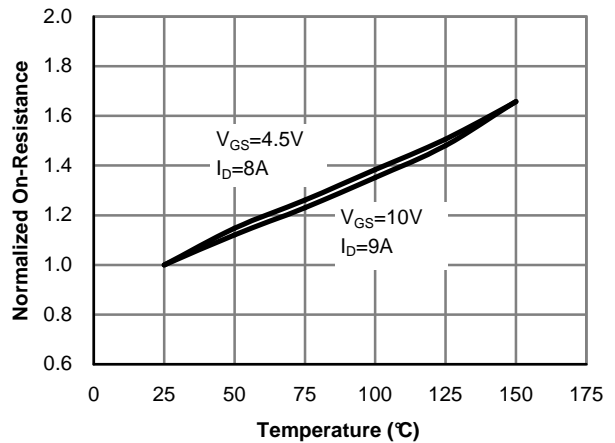

Figure 4: On-Resistance vs. Junction Temperature(Note E)

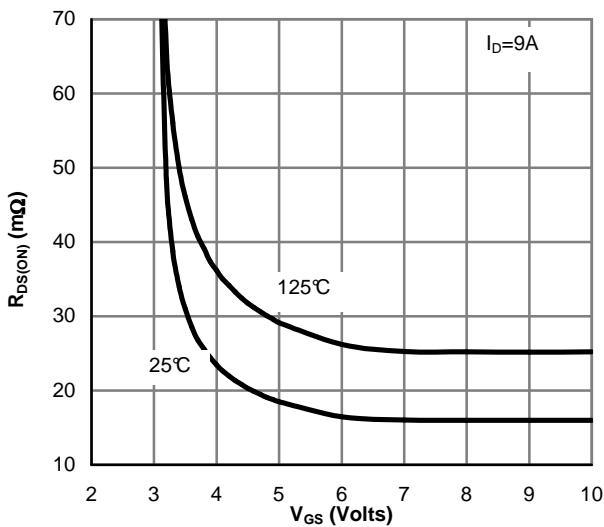

Figure 5: On-Resistance vs. Gate-Source Voltage(Note E)

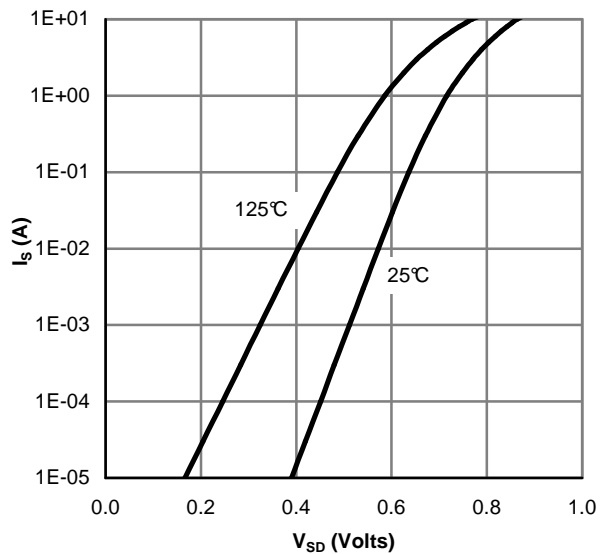

Figure 6: Body-Diode Characteristics(Note E)

TYPICAL ELECTRICAL AND THERMAL CHARACTERISTICS

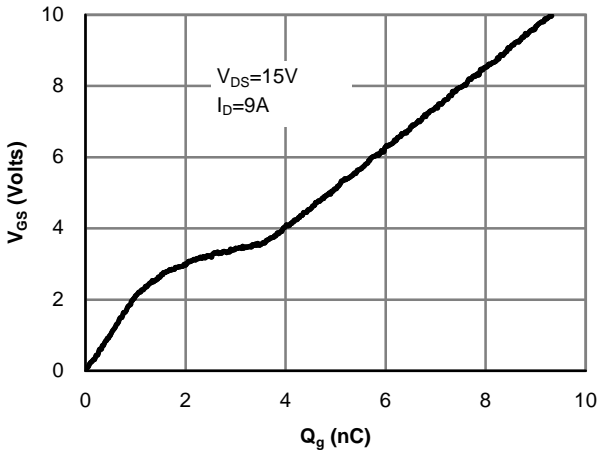

Figure 7: Gate-Charge Characteristics

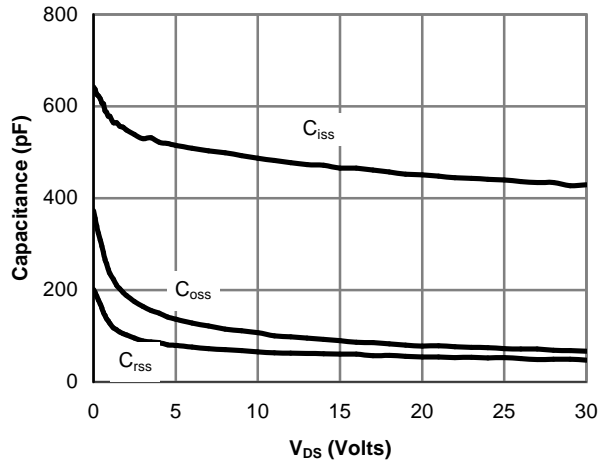

Figure 8: Capacitance Characteristics

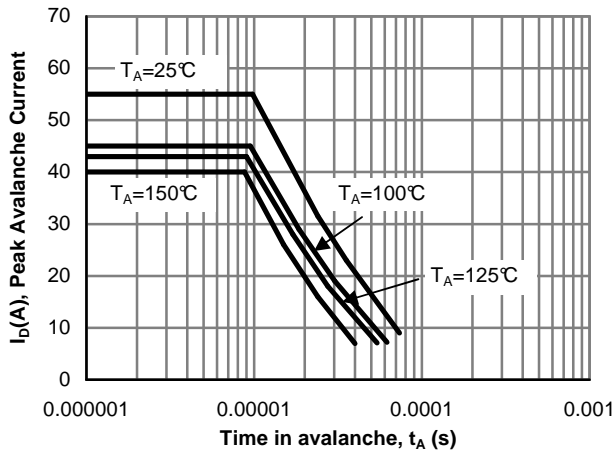

Figure 9: Single Pulse Avalanche capability (Note C)

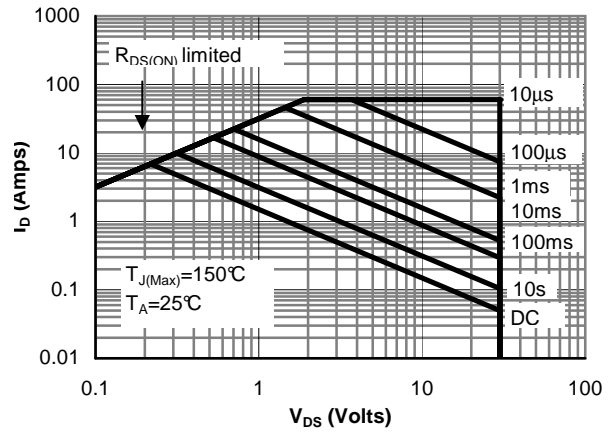

Figure 10: Maximum Forward Biased Safe Operating Area (Note F)

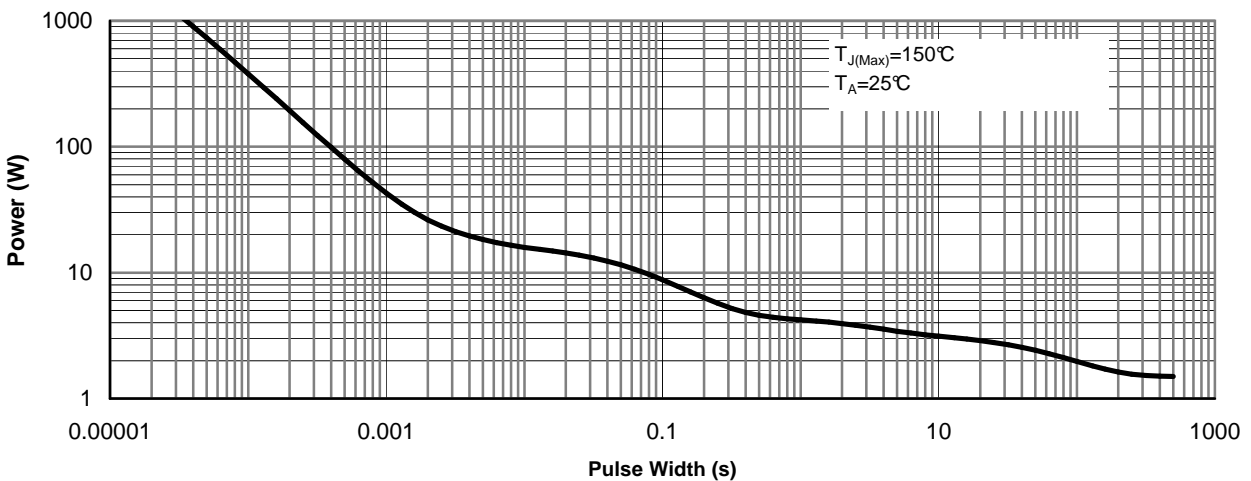

Figure 11: Single Pulse Power Rating Junction-to-Ambient (Note F)

TYPICAL ELECTRICAL AND THERMAL CHARACTERISTICS

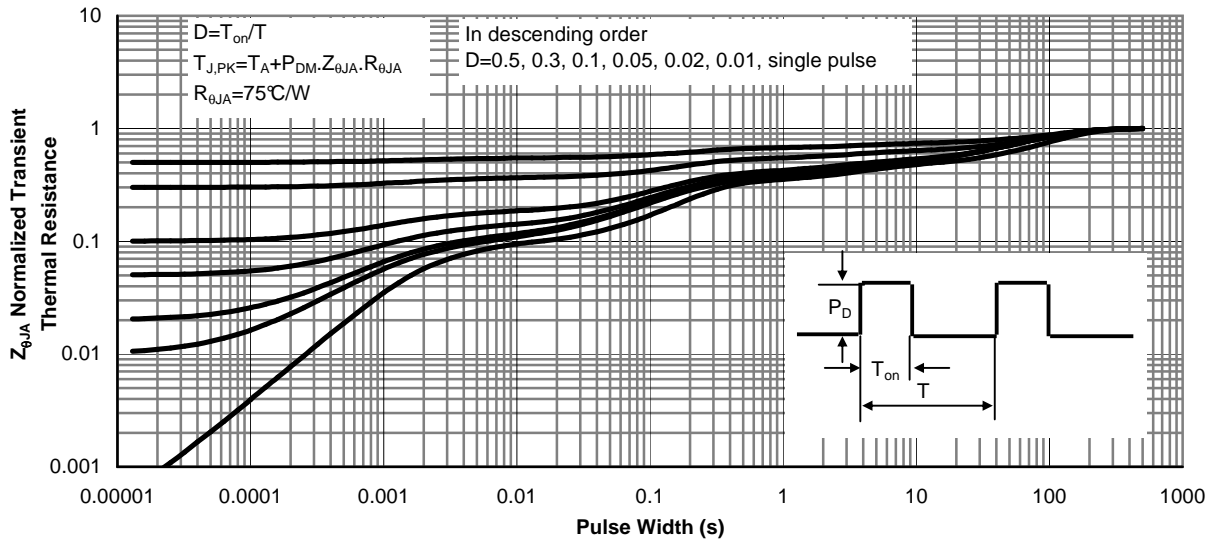
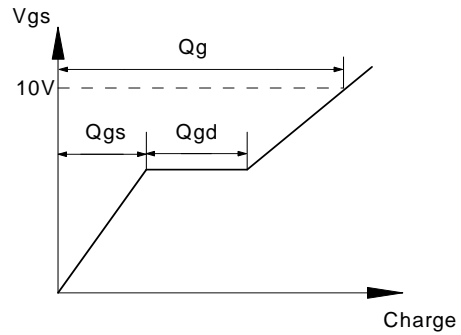
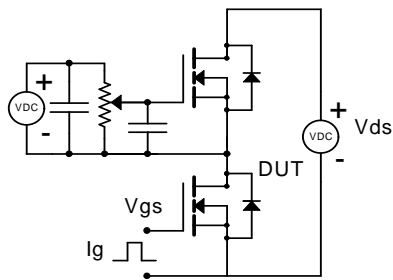
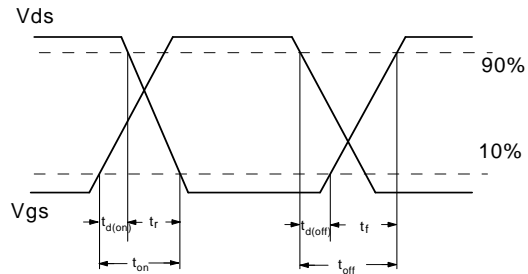
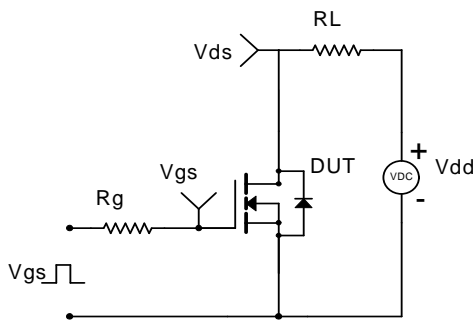

Figure 12: Normalized Maximum Transient Thermal Impedance (Note F)

Gate Charge Test Circuit & Waveform



Resistive Switching Test Circuit & Waveforms



Unclamped Inductive Switching (UIS) Test Circuit & Waveforms

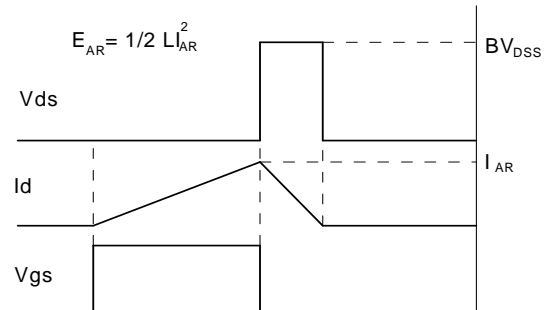
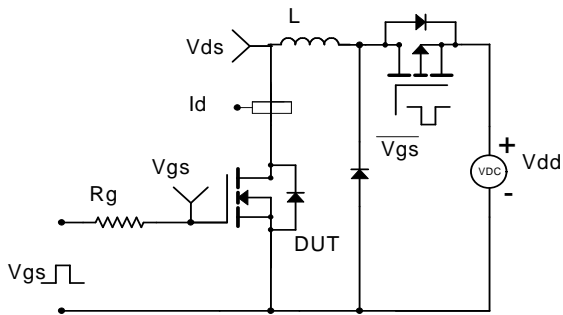

Diode Recovery Test Circuit & Waveforms

