

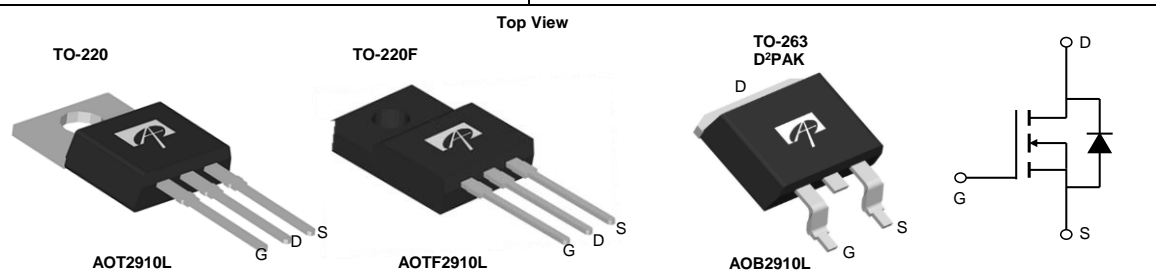
**General Description**

The AOT2910L & AOB2910L & AOTF2910L uses trench MOSFET technology that is uniquely optimized to provide the most efficient high frequency switching performance. Both conduction and switching power losses are minimized due to an extremely low combination of  $R_{DS(ON)}$ ,  $C_{iss}$  and  $C_{oss}$ . This device is ideal for boost converters and synchronous rectifiers for consumer, telecom, industrial power supplies and LED backlighting.

**Product Summary**

$V_{DS}$	100V
$I_D$ (at $V_{GS}=10V$ )	30A / 22A
$R_{DS(ON)}$ (at $V_{GS}=10V$ )	< 24m $\Omega$ (* 23.5m $\Omega$ )
$R_{DS(ON)}$ (at $V_{GS}=4.5V$ )	< 33m $\Omega$ (* 32.5m $\Omega$ )

100% UIS Tested  
 100%  $R_g$  Tested


**Absolute Maximum Ratings**  $T_A=25^\circ C$  unless otherwise noted

Parameter	Symbol	AOT2910L/AOB2910L	AOTF2910L	Units
Drain-Source Voltage	$V_{DS}$	100		V
Gate-Source Voltage	$V_{GS}$	$\pm 20$		V
Continuous Drain Current	$I_D$	$T_C=25^\circ C$	30	A
		$T_C=100^\circ C$	21	
Pulsed Drain Current <sup>C</sup>	$I_{DM}$	80		A
Continuous Drain Current	$I_{DSM}$	$T_A=25^\circ C$	6.0	A
		$T_A=70^\circ C$	4.5	
Avalanche Current <sup>C</sup>	$I_{AS}$	15		A
Avalanche energy $L=0.1mH$ <sup>C</sup>	$E_{AS}$	11		mJ
Power Dissipation <sup>B</sup>	$P_D$	$T_C=25^\circ C$	50	W
		$T_C=100^\circ C$	25	
Power Dissipation <sup>A</sup>	$P_{DSM}$	$T_A=25^\circ C$	2.1	W
		$T_A=70^\circ C$	1.3	
Junction and Storage Temperature Range	$T_J, T_{STG}$	-55 to 175		$^\circ C$

**Thermal Characteristics**

Parameter	Symbol	AOT2910L/AOB2910L	AOTF2910L	Units
Maximum Junction-to-Ambient <sup>A</sup>	$R_{\theta JA}$	15	15	$^\circ C/W$
Maximum Junction-to-Ambient <sup>A,D</sup>		Steady-State	60	60
Maximum Junction-to-Case	$R_{\theta JC}$	3	5.5	$^\circ C/W$

\* Surface mount package TO263

**Electrical Characteristics (T<sub>J</sub>=25°C unless otherwise noted)**

Symbol	Parameter	Conditions	Min	Typ	Max	Units	
<b>STATIC PARAMETERS</b>							
BV <sub>DSS</sub>	Drain-Source Breakdown Voltage	I <sub>D</sub> =250μA, V <sub>GS</sub> =0V	100			V	
I <sub>DSS</sub>	Zero Gate Voltage Drain Current	V <sub>DS</sub> =100V, V <sub>GS</sub> =0V T <sub>J</sub> =55°C			1 5	μA	
I <sub>GSS</sub>	Gate-Body leakage current	V <sub>DS</sub> =0V, V <sub>GS</sub> =±20V			±100	nA	
V <sub>GS(th)</sub>	Gate Threshold Voltage	V <sub>DS</sub> =V <sub>GS</sub> , I <sub>D</sub> =250μA	1.6	2.15	2.7	V	
I <sub>D(ON)</sub>	On state drain current	V <sub>GS</sub> =10V, V <sub>DS</sub> =5V	80			A	
R <sub>DS(ON)</sub>	Static Drain-Source On-Resistance	V <sub>GS</sub> =10V, I <sub>D</sub> =20A TO220/TO220F T <sub>J</sub> =125°C		19 34	24 43	mΩ	
		V <sub>GS</sub> =4.5V, I <sub>D</sub> =18A TO220/TO220F		24.5	33	mΩ	
		V <sub>GS</sub> =10V, I <sub>D</sub> =20A TO263		18.5	23.5	mΩ	
		V <sub>GS</sub> =4.5V, I <sub>D</sub> =18A TO263		24	32.5	mΩ	
g <sub>FS</sub>	Forward Transconductance	V <sub>DS</sub> =5V, I <sub>D</sub> =20A		40		S	
V <sub>SD</sub>	Diode Forward Voltage	I <sub>S</sub> =1A, V <sub>GS</sub> =0V		0.72	1	V	
I <sub>S</sub>	Maximum Body-Diode Continuous Current				30	A	
<b>DYNAMIC PARAMETERS</b>							
C <sub>iss</sub>	Input Capacitance	V <sub>GS</sub> =0V, V <sub>DS</sub> =50V, f=1MHz		1190		pF	
C <sub>oss</sub>	Output Capacitance			95		pF	
C <sub>rss</sub>	Reverse Transfer Capacitance			7		pF	
R <sub>g</sub>	Gate resistance	V <sub>GS</sub> =0V, V <sub>DS</sub> =0V, f=1MHz	0.5	1.1	1.7	Ω	
<b>SWITCHING PARAMETERS</b>							
Q <sub>g</sub> (10V)	Total Gate Charge	V <sub>GS</sub> =10V, V <sub>DS</sub> =50V, I <sub>D</sub> =20A		16.5	25	nC	
Q <sub>g</sub> (4.5V)	Total Gate Charge			7	12	nC	
Q <sub>gs</sub>	Gate Source Charge			4.5		nC	
Q <sub>gd</sub>	Gate Drain Charge			2.5		nC	
t <sub>D(on)</sub>	Turn-On DelayTime	V <sub>GS</sub> =10V, V <sub>DS</sub> =50V, R <sub>L</sub> =2.5Ω, R <sub>GEN</sub> =3Ω		7		ns	
t <sub>r</sub>	Turn-On Rise Time			8		ns	
t <sub>D(off)</sub>	Turn-Off DelayTime			20		ns	
t <sub>f</sub>	Turn-Off Fall Time			3		ns	
t <sub>rr</sub>	Body Diode Reverse Recovery Time		I <sub>F</sub> =20A, di/dt=500A/μs		30		ns
Q <sub>rr</sub>	Body Diode Reverse Recovery Charge	I <sub>F</sub> =20A, di/dt=500A/μs		145		nC	

A. The value of R<sub>θJA</sub> is measured with the device mounted on 1in<sup>2</sup> FR-4 board with 2oz. Copper, in a still air environment with T<sub>A</sub>=25° C. The Power dissipation P<sub>DSM</sub> is based on R<sub>θJA</sub> and the maximum allowed junction temperature of 150° C. The value in any given application depends on the user's specific board design, and the maximum temperature of 175° C may be used if the PCB allows it.

B. The power dissipation P<sub>D</sub> is based on T<sub>J(MAX)</sub>=175° C, using junction-to-case thermal resistance, and is more useful in setting the upper dissipation limit for cases where additional heatsinking is used.

C. Repetitive rating, pulse width limited by junction temperature T<sub>J(MAX)</sub>=175° C. Ratings are based on low frequency and duty cycles to keep initial T<sub>J</sub>=25° C.

D. The R<sub>θJA</sub> is the sum of the thermal impedance from junction to case R<sub>θJC</sub> and case to ambient.

E. The static characteristics in Figures 1 to 6 are obtained using <300μs pulses, duty cycle 0.5% max.

F. These curves are based on the junction-to-case thermal impedance which is measured with the device mounted to a large heatsink, assuming a maximum junction temperature of T<sub>J(MAX)</sub>=175° C. The SOA curve provides a single pulse rating.

G. The maximum current limited by package.

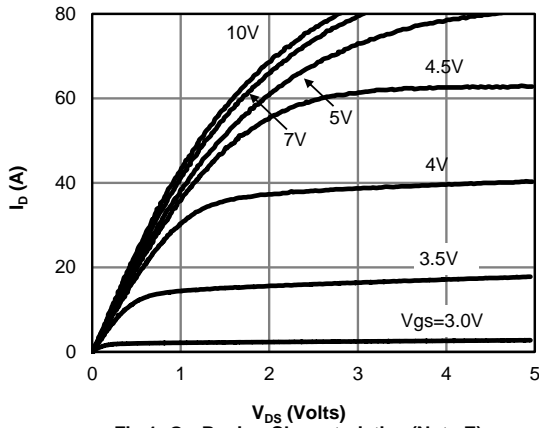
H. These tests are performed with the device mounted on 1 in<sup>2</sup> FR-4 board with 2oz. Copper, in a still air environment with T<sub>A</sub>=25° C.

APPLICATIONS OR USES AS CRITICAL COMPONENTS IN LIFE SUPPORT DEVICES OR SYSTEMS ARE NOT AUTHORIZED. AOS DOES NOT ASSUME ANY LIABILITY ARISING OUT OF SUCH APPLICATIONS OR USES OF ITS PRODUCTS. AOS RESERVES THE RIGHT TO MAKE CHANGES TO PRODUCT SPECIFICATIONS WITHOUT NOTICE. IT IS THE RESPONSIBILITY OF THE CUSTOMER TO EVALUATE SUITABILITY OF THE PRODUCT FOR THEIR INTENDED APPLICATION. CUSTOMER SHALL COMPLY WITH APPLICABLE LEGAL REQUIREMENTS, INCLUDING ALL APPLICABLE EXPORT CONTROL RULES, REGULATIONS AND LIMITATIONS.

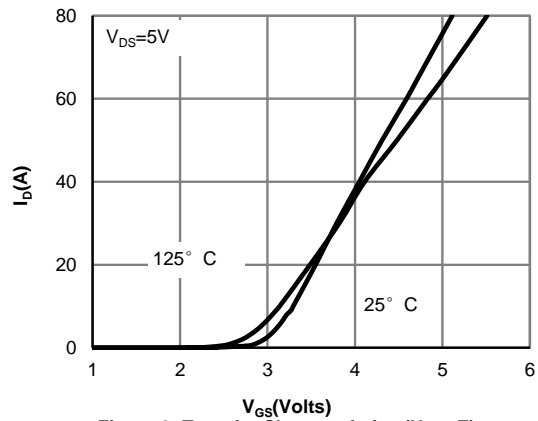
AOS' products are provided subject to AOS' terms and conditions of sale which are set forth at:

[http://www.aosmd.com/terms\\_and\\_conditions\\_of\\_sale](http://www.aosmd.com/terms_and_conditions_of_sale)

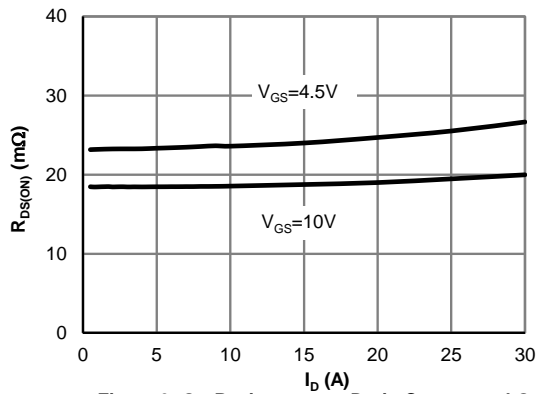
**TYPICAL ELECTRICAL AND THERMAL CHARACTERISTICS**



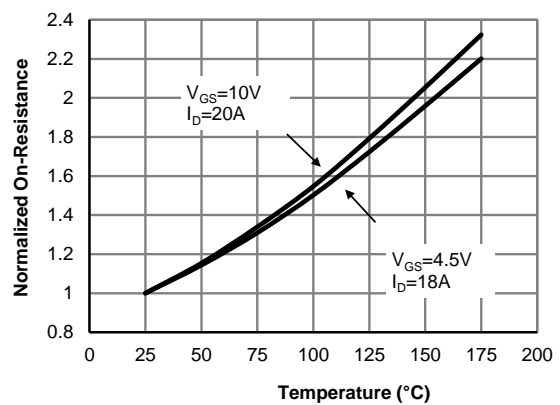
**Fig 1: On-Region Characteristics (Note E)**



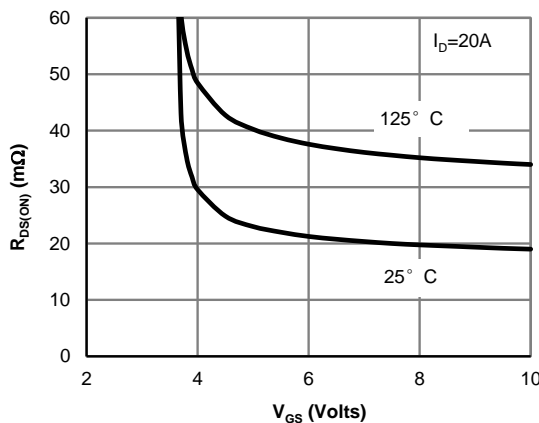
**Figure 2: Transfer Characteristics (Note E)**



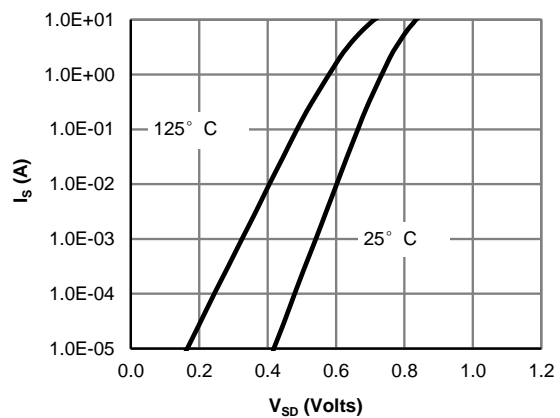
**Figure 3: On-Resistance vs. Drain Current and Gate Voltage (Note E)**



**Figure 4: On-Resistance vs. Junction Temperature (Note E)**

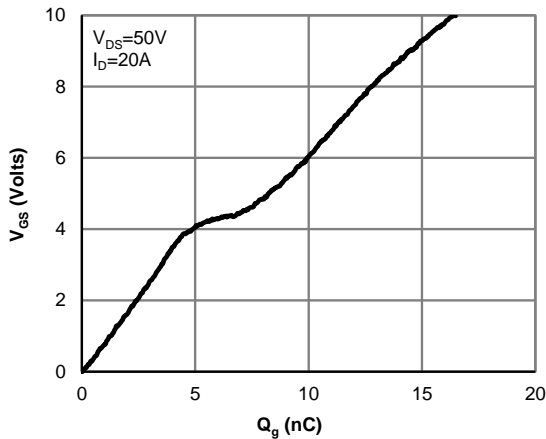


**Figure 5: On-Resistance vs. Gate-Source Voltage (Note E)**

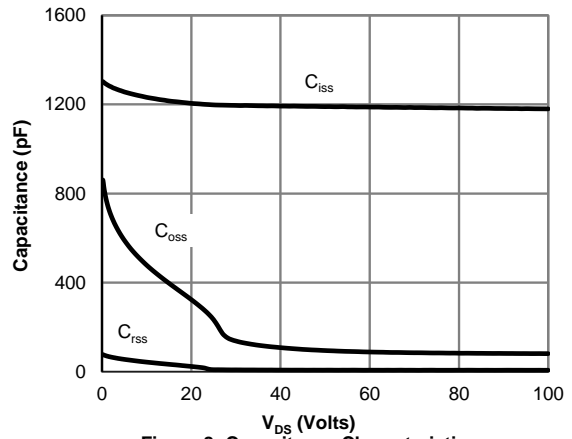


**Figure 6: Body-Diode Characteristics (Note E)**

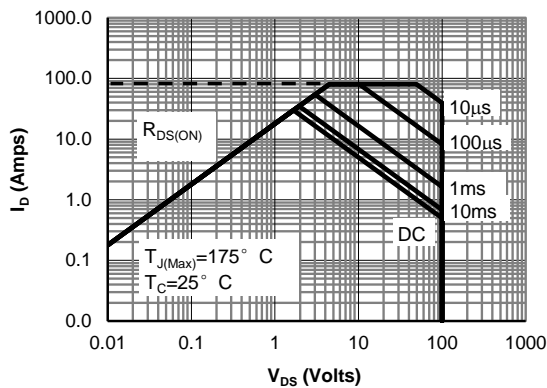
**TYPICAL ELECTRICAL AND THERMAL CHARACTERISTICS**



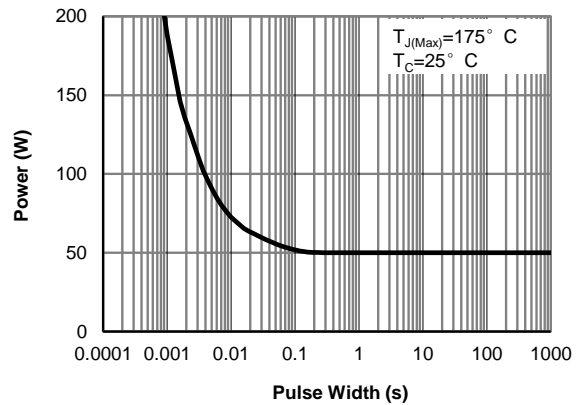
**Figure 7: Gate-Charge Characteristics**



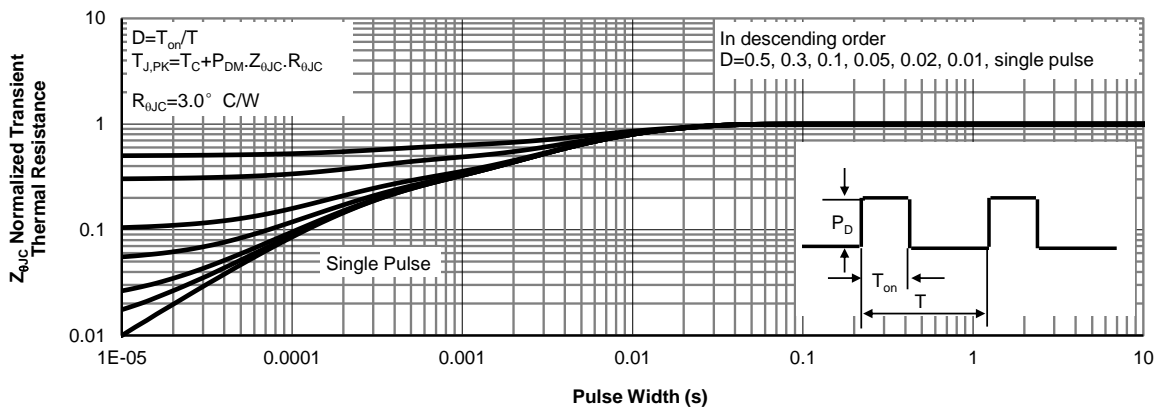
**Figure 8: Capacitance Characteristics**



**Figure 9: Maximum Forward Biased Safe Operating Area for AOT2910L and AOB2910L (Note F)**

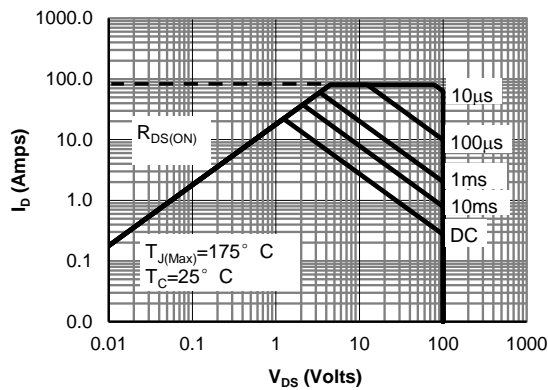


**Figure 10: Single Pulse Power Rating Junction-to-Case for AOT2910L and AOB2910L (Note F)**

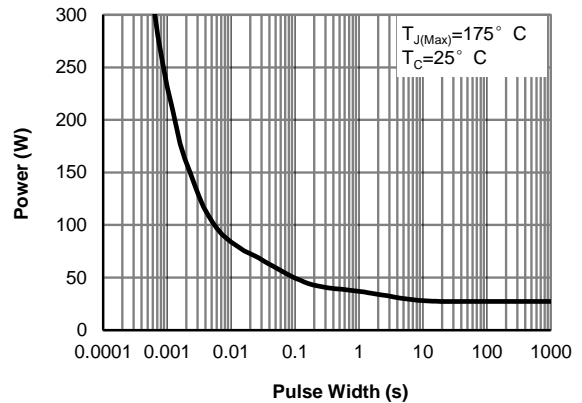


**Figure 11: Normalized Maximum Transient Thermal Impedance for AOT2910L and AOB2910L (Note F)**

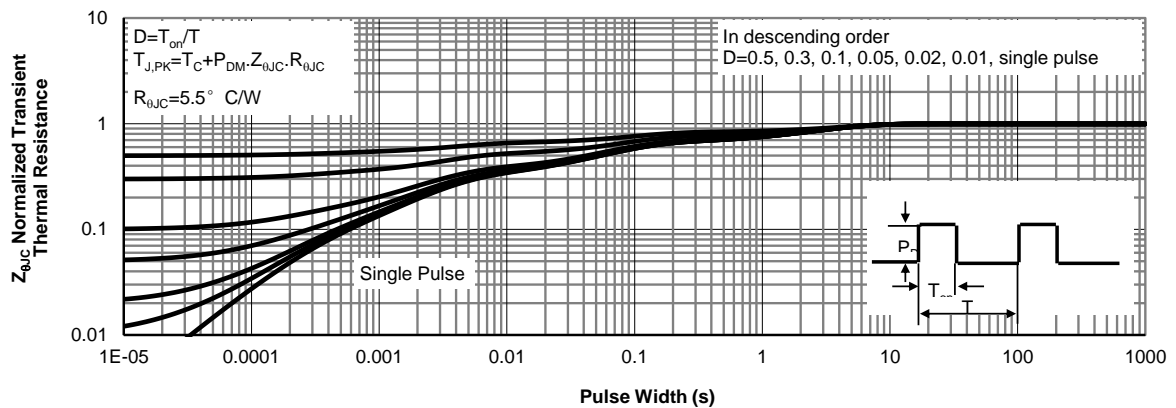
**TYPICAL ELECTRICAL AND THERMAL CHARACTERISTICS**



**Figure 9: Maximum Forward Biased Safe Operating Area for AOTF2910L**

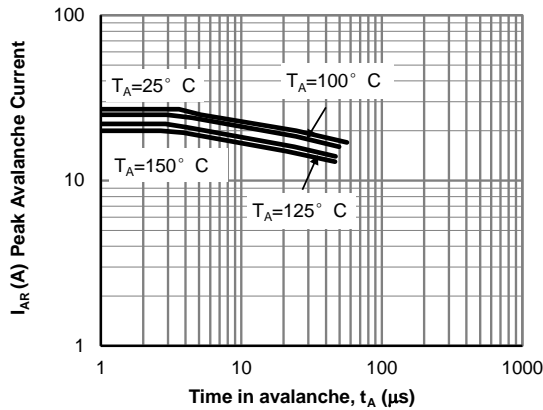


**Figure 10: Single Pulse Power Rating Junction-to-Case for AOTF2910L (Note F)**

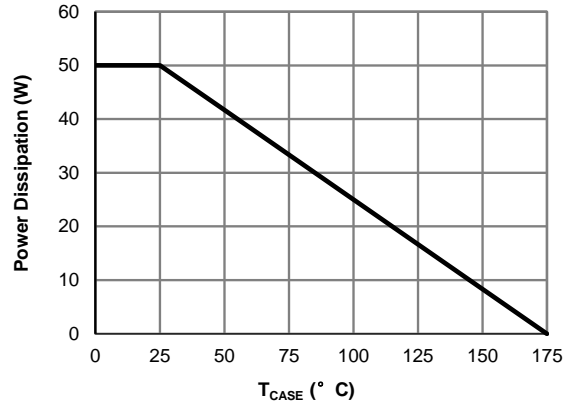


**Figure 11: Normalized Maximum Transient Thermal Impedance for AOTF2910L (Note F)**

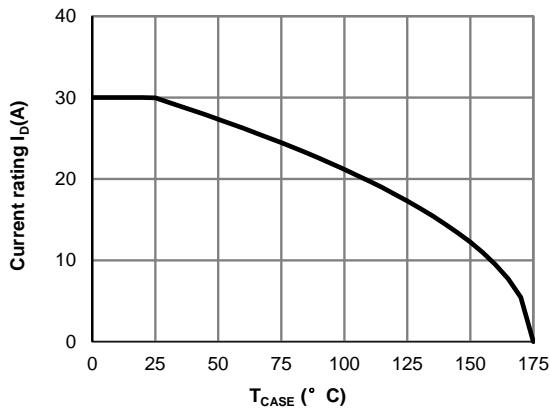
**TYPICAL ELECTRICAL AND THERMAL CHARACTERISTICS**



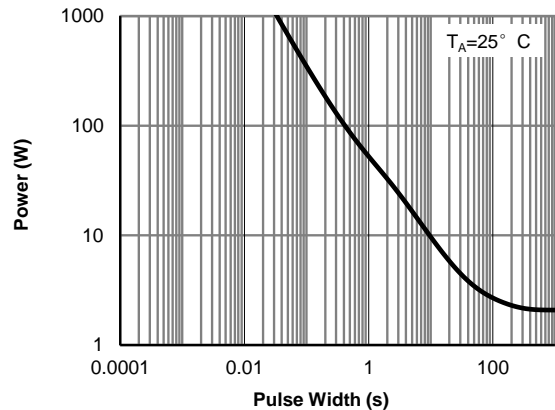
**Figure 12: Single Pulse Avalanche capability (Note C)**



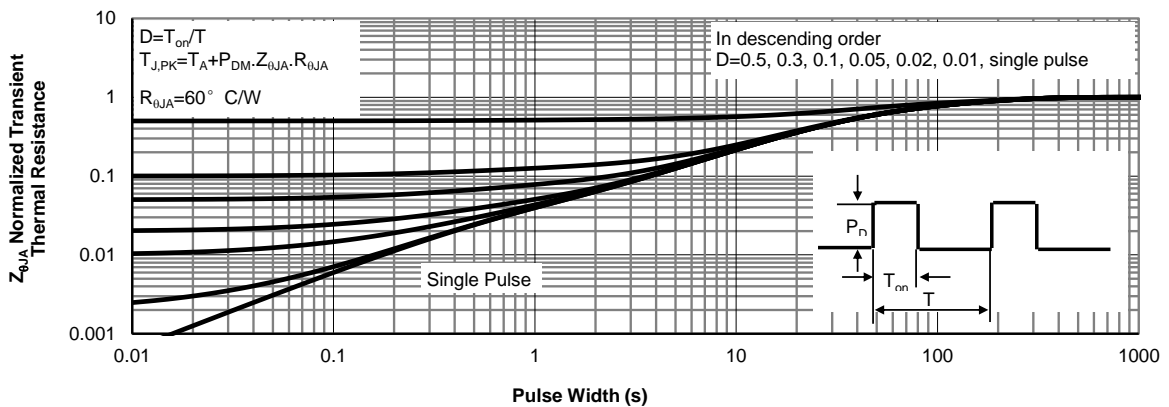
**Figure 13: Power De-rating (Note F)**



**Figure 14: Current De-rating (Note F)**

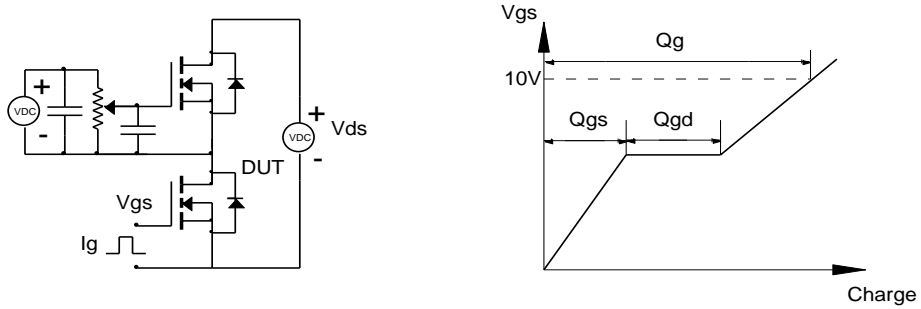


**Figure 15: Single Pulse Power Rating Junction-to-Ambient (Note H)**

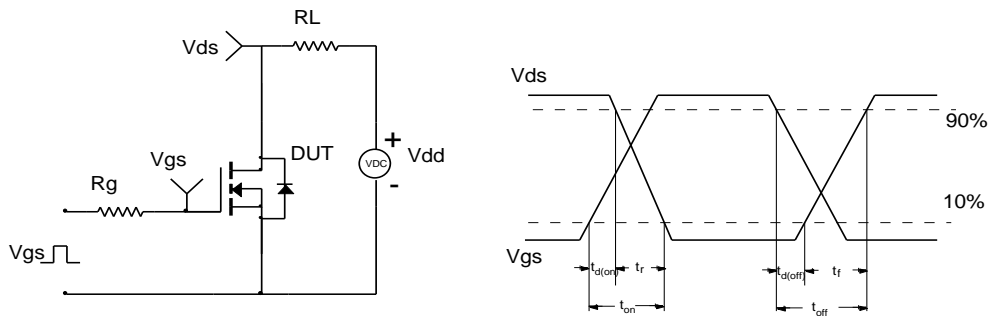


**Figure 16: Normalized Maximum Transient Thermal Impedance (Note H)**

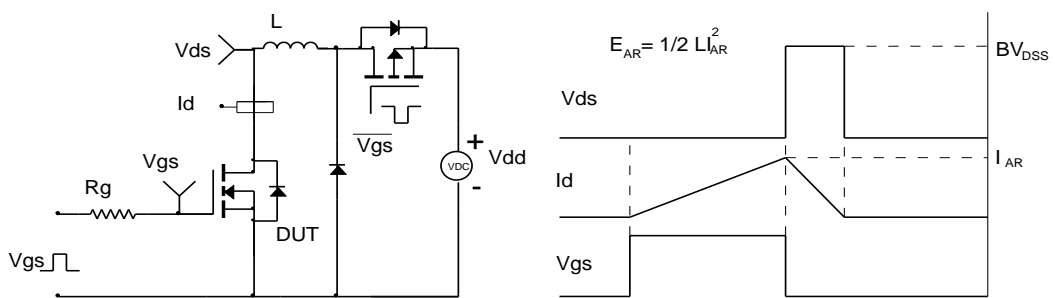
**Gate Charge Test Circuit & Waveform**



**Resistive Switching Test Circuit & Waveforms**



**Unclamped Inductive Switching (UIS) Test Circuit & Waveforms**



**Diode Recovery Test Circuit & Waveforms**

