

General Description

The AOC2412 uses advanced trench technology to provide excellent $R_{DS(ON)}$, low gate charge and operation with gate voltages as low as 1.8V while retaining a 8V $V_{GS(MAX)}$ rating.

Product Summary

V_{DS}	20V
I_D (at $V_{GS}=4.5V$)	4.5A
$R_{DS(ON)}$ (at $V_{GS}=4.5V$)	< 23m Ω
$R_{DS(ON)}$ (at $V_{GS}=2.5V$)	< 26m Ω
$R_{DS(ON)}$ (at $V_{GS}=1.8V$)	< 30m Ω

Typical ESD protection **HBM Class 3A**

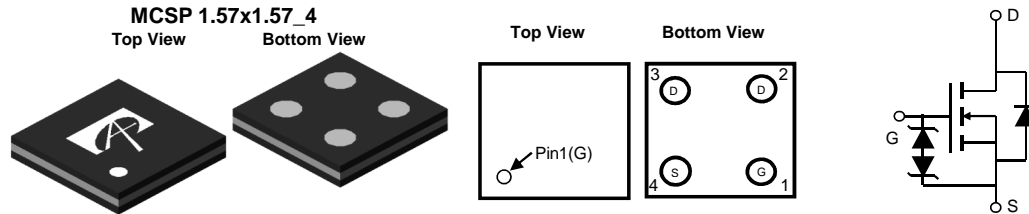

Absolute Maximum Ratings $T_A=25^\circ\text{C}$ unless otherwise noted

Parameter	Symbol	Maximum	Units
Drain-Source Voltage	V_{DS}	20	V
Gate-Source Voltage	V_{GS}	± 8	V
Source Current (DC) ^{Note1}	I_D	4.5	A
Source Current (Pulse) ^{Note2}			
Power Dissipation ^{Note1}	P_D	0.55	W
Junction and Storage Temperature Range	T_J, T_{STG}	-55 to 150	$^\circ\text{C}$

Thermal Characteristics

Parameter	Symbol	Typ	Max	Units
Maximum Junction-to-Ambient ^A	$R_{\theta JA}$	140	170	$^\circ\text{C/W}$
Maximum Junction-to-Ambient ^{A,D}		190	230	$^\circ\text{C/W}$

Note 1. Mounted on minimum pad PCB

Note 2. PW < 300 μs pulses, duty cycle 0.5% max

Electrical Characteristics (T_J=25°C unless otherwise noted)

Symbol	Parameter	Conditions	Min	Typ	Max	Units
STATIC PARAMETERS						
BV _{DSS}	Drain-Source Breakdown Voltage	I _D =250μA, V _{GS} =0V	20			V
I _{DSS}	Zero Gate Voltage Drain Current	V _{DS} =20V, V _{GS} =0V T _J =55°C			1 5	μA
I _{GSS}	Gate-Body leakage current	V _{DS} =0V, V _{GS} =±8V			±10	μA
V _{GS(th)}	Gate Threshold Voltage	V _{DS} =V _{GS} , I _D =250μA	0.4	0.7	1.0	V
R _{DS(on)}	Static Drain-Source On-Resistance	V _{GS} =4.5V, I _D =1.5A T _J =125°C		18 22.5	23 29	mΩ
		V _{GS} =2.5V, I _D =1A		20	26	mΩ
		V _{GS} =1.8V, I _D =1A		22	30	mΩ
g _{FS}	Forward Transconductance	V _{DS} =5V, I _D =1.5A		30		S
V _{SD}	Diode Forward Voltage	I _S =1A, V _{GS} =0V		0.65	1	V
DYNAMIC PARAMETERS						
C _{iss}	Input Capacitance			1842		pF
C _{oss}	Output Capacitance	V _{GS} =0V, V _{DS} =10V, f=1MHz		245		pF
C _{rss}	Reverse Transfer Capacitance			70		pF
R _g	Gate resistance	V _{GS} =0V, V _{DS} =0V, f=1MHz		2.7		KΩ
SWITCHING PARAMETERS						
Q _g	Total Gate Charge			21.5	32	nC
Q _{gs}	Gate Source Charge	V _{GS} =4.5V, V _{DS} =10V, I _D =1.5A		10.5		nC
Q _{gd}	Gate Drain Charge			4.5		nC
t _{D(on)}	Turn-On DelayTime			2.5		μs
t _r	Turn-On Rise Time	V _{GS} =4.5V, V _{DS} =10V, R _L =6.67Ω, R _{GEN} =3Ω		4		μs
t _{D(off)}	Turn-Off DelayTime			5		μs
t _f	Turn-Off Fall Time			8		μs
t _{rr}	Body Diode Reverse Recovery Time	I _F =1.5A, di/dt=100A/μs		20		ns
Q _{rr}	Body Diode Reverse Recovery Charge	I _F =1.5A, di/dt=100A/μs		10		nC

THIS PRODUCT HAS BEEN DESIGNED AND QUALIFIED FOR THE CONSUMER MARKET. APPLICATIONS OR USES AS CRITICAL COMPONENTS IN LIFE SUPPORT DEVICES OR SYSTEMS ARE NOT AUTHORIZED. AOS DOES NOT ASSUME ANY LIABILITY ARISING OUT OF SUCH APPLICATIONS OR USES OF ITS PRODUCTS. AOS RESERVES THE RIGHT TO IMPROVE PRODUCT DESIGN, FUNCTIONS AND RELIABILITY WITHOUT NOTICE.

TYPICAL ELECTRICAL AND THERMAL CHARACTERISTICS

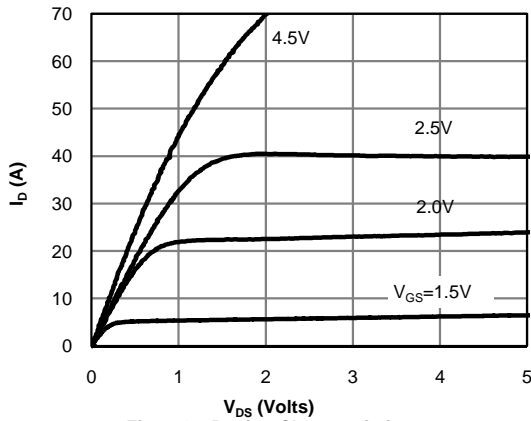

Fig 1: On-Region Characteristics

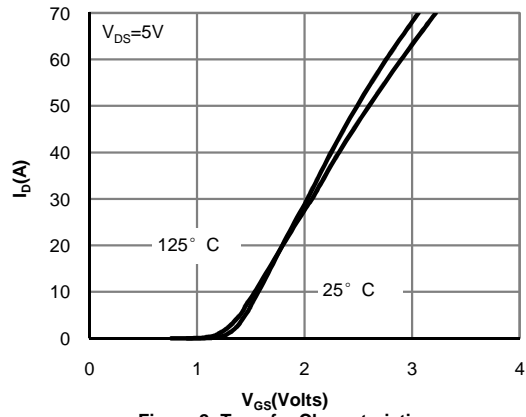

Figure 2: Transfer Characteristics

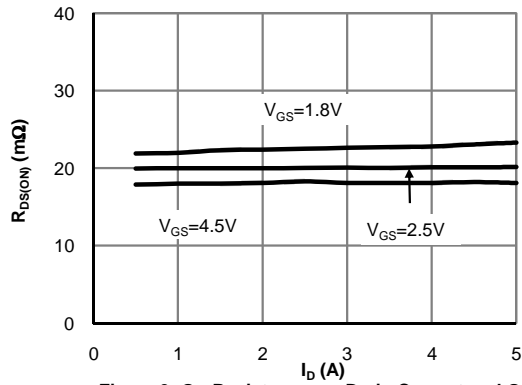

Figure 3: On-Resistance vs. Drain Current and Gate Voltage (Note E)

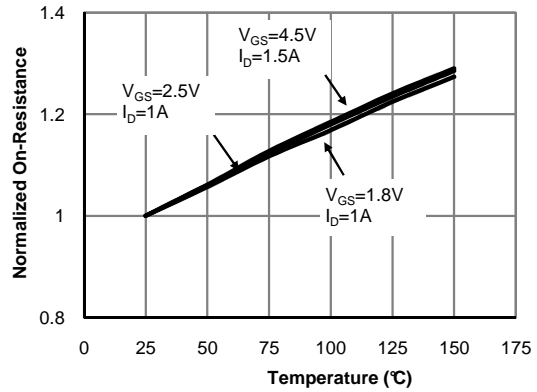

Figure 4: On-Resistance vs. Junction Temperature (Note E)

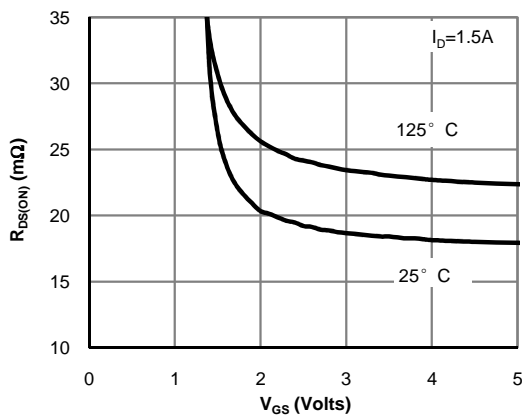

Figure 5: On-Resistance vs. Gate-Source Voltage (Note E)

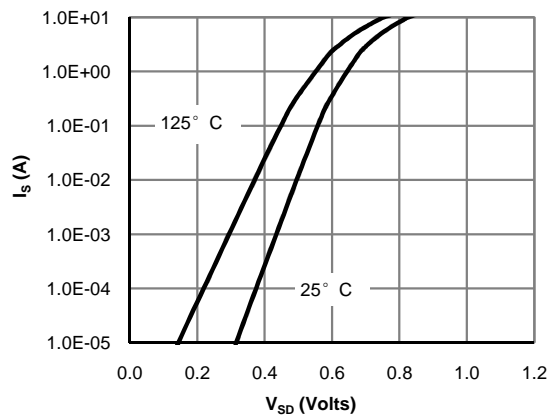

Figure 6: Body-Diode Characteristics (Note E)

TYPICAL ELECTRICAL AND THERMAL CHARACTERISTICS

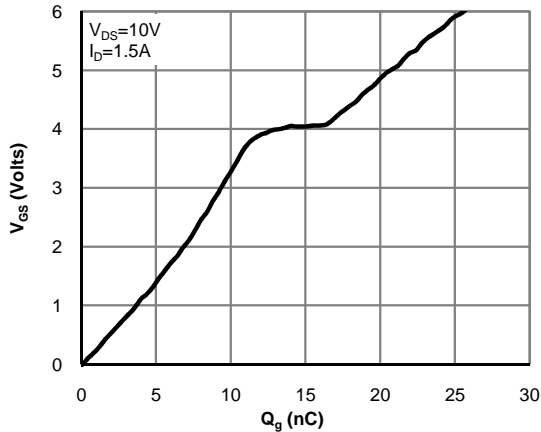

Figure 7: Gate-Charge Characteristics

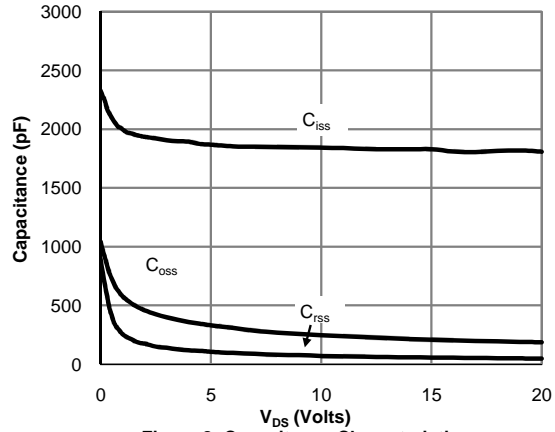

Figure 8: Capacitance Characteristics

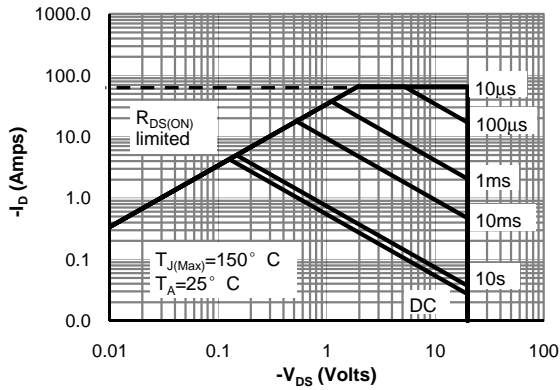

Figure 9: Maximum Forward Biased Safe Operating Area

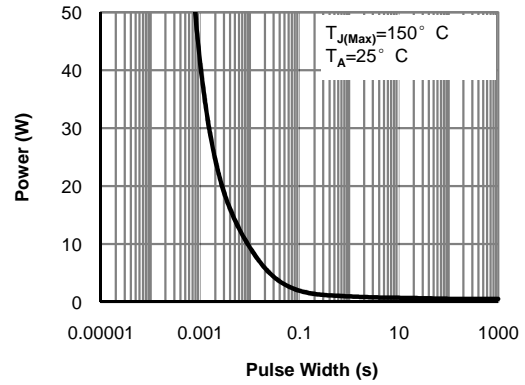

Figure 10: Single Pulse Power Rating Junction-to-Ambient

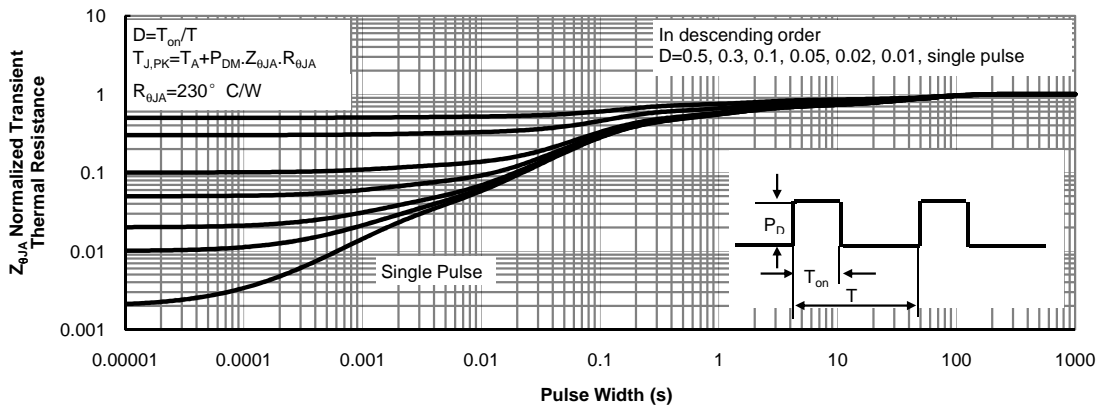
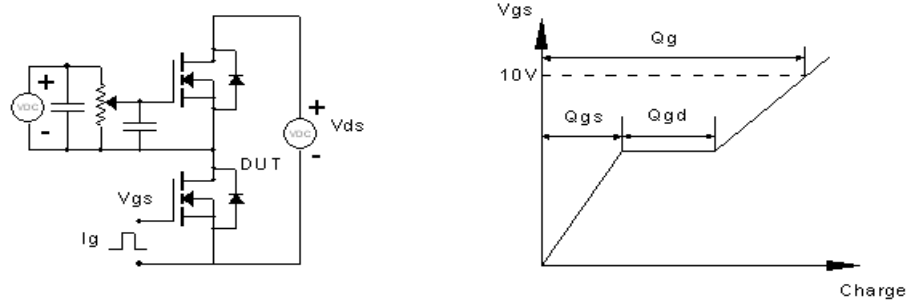
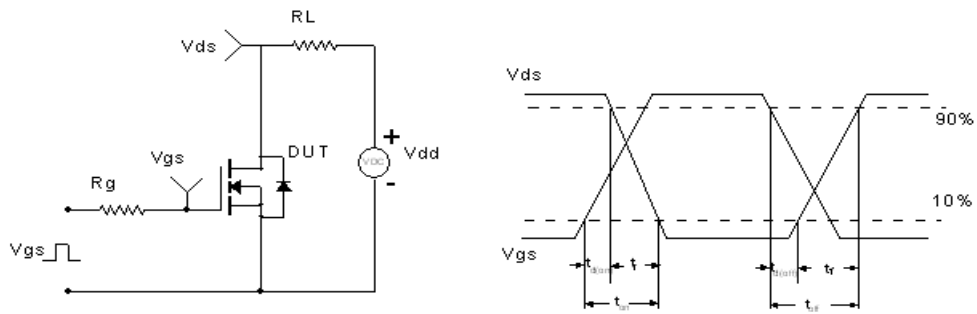

Figure 11: Normalized Maximum Transient Thermal Impedance

Gate Charge Test Circuit & Waveform



Resistive Switching Test Circuit & Waveforms



Diode Recovery Test Circuit & Waveforms

