

### General Description

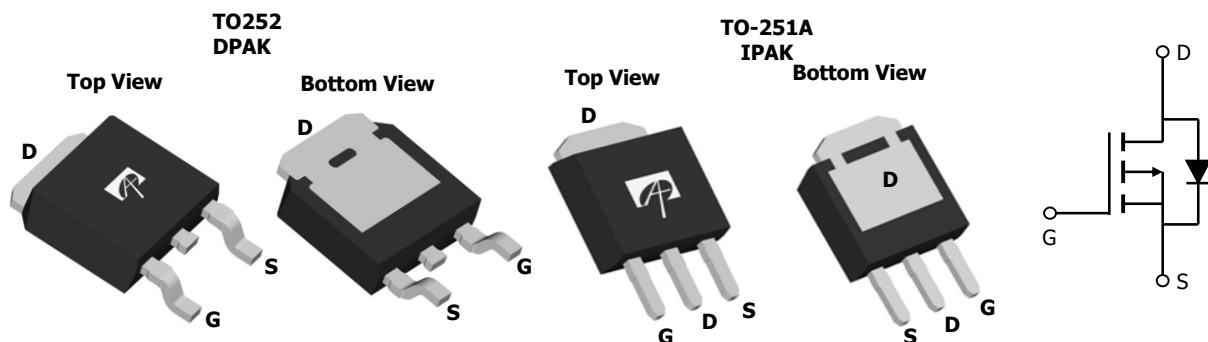
The AOD4185/AOI4185 uses advanced trench technology to provide excellent  $R_{DS(ON)}$  and low gate charge. With the excellent thermal resistance of the DPAK/IPAK package, this device is well suited for high current applications.

- RoHS Compliant
- Halogen Free\*

### Features

$V_{DS}$  (V) = -40V  
 $I_D$  = -40A ( $V_{GS} = -10V$ )  
 $R_{DS(ON)} < 15m\Omega$  ( $V_{GS} = -10V$ )  
 $R_{DS(ON)} < 20m\Omega$  ( $V_{GS} = -4.5V$ )

**100% UIS Tested!**  
**100% Rg Tested!**



### Absolute Maximum Ratings $T_C=25^\circ C$ unless otherwise noted

Parameter	Symbol	Maximum	Units
Drain-Source Voltage	$V_{DS}$	-40	V
Gate-Source Voltage	$V_{GS}$	$\pm 20$	V
Continuous Drain Current <sup>B,H</sup>	$I_D$	$T_C=25^\circ C$	-40
		$T_C=100^\circ C$	-31
Pulsed Drain Current <sup>C</sup>	$I_{DM}$	-115	A
Avalanche Current <sup>C</sup>	$I_{AR}$	-42	
Repetitive avalanche energy $L=0.1mH$ <sup>C</sup>	$E_{AR}$	88	mJ
Power Dissipation <sup>B</sup>	$P_D$	$T_C=25^\circ C$	62.5
		$T_C=100^\circ C$	31
Power Dissipation <sup>A</sup>	$P_{DSM}$	$T_A=25^\circ C$	2.5
		$T_A=70^\circ C$	1.6
Junction and Storage Temperature Range	$T_J, T_{STG}$	-55 to 175	$^\circ C$

### Thermal Characteristics

Parameter	Symbol	Typ	Max	Units
Maximum Junction-to-Ambient <sup>A,G</sup>	$R_{\theta JA}$	$t \leq 10s$	15	$^\circ C/W$
Maximum Junction-to-Ambient <sup>A,G</sup>		Steady-State	41	$^\circ C/W$
Maximum Junction-to-Case <sup>D,F</sup>	$R_{\theta JC}$	2	2.4	$^\circ C/W$

**Electrical Characteristics (T<sub>J</sub>=25°C unless otherwise noted)**

Symbol	Parameter	Conditions	Min	Typ	Max	Units
<b>STATIC PARAMETERS</b>						
BV <sub>DSS</sub>	Drain-Source Breakdown Voltage	I <sub>D</sub> =-250μA, V <sub>GS</sub> =0V	-40			V
I <sub>DSS</sub>	Zero Gate Voltage Drain Current	V <sub>DS</sub> =-40V, V <sub>GS</sub> =0V T <sub>J</sub> =55°C			-1 -5	μA
I <sub>GSS</sub>	Gate-Body leakage current	V <sub>DS</sub> =0V, V <sub>GS</sub> = ±20V			±100	nA
V <sub>GS(th)</sub>	Gate Threshold Voltage	V <sub>DS</sub> =V <sub>GS</sub> I <sub>D</sub> =-250μA	-1.7	-1.9	-3	V
I <sub>D(ON)</sub>	On state drain current	V <sub>GS</sub> =-10V, V <sub>DS</sub> =-5V	-115			A
R <sub>DS(ON)</sub>	Static Drain-Source On-Resistance	V <sub>GS</sub> =-10V, I <sub>D</sub> =-20A T <sub>J</sub> =125°C		12.5 19	15 23	mΩ
		V <sub>GS</sub> =-4.5V, I <sub>D</sub> =-15A		16	20	
g <sub>FS</sub>	Forward Transconductance	V <sub>DS</sub> =-5V, I <sub>D</sub> =-20A		50		S
V <sub>SD</sub>	Diode Forward Voltage	I <sub>S</sub> =-1A, V <sub>GS</sub> =0V		-0.72	-1	V
I <sub>S</sub>	Maximum Body-Diode Continuous Current				-20	A
<b>DYNAMIC PARAMETERS</b>						
C <sub>iss</sub>	Input Capacitance	V <sub>GS</sub> =0V, V <sub>DS</sub> =-20V, f=1MHz		2550		pF
C <sub>oss</sub>	Output Capacitance			280		pF
C <sub>rss</sub>	Reverse Transfer Capacitance			190		pF
R <sub>g</sub>	Gate resistance	V <sub>GS</sub> =0V, V <sub>DS</sub> =0V, f=1MHz	2.5	4	6	Ω
<b>SWITCHING PARAMETERS</b>						
Q <sub>g</sub> (-10V)	Total Gate Charge	V <sub>GS</sub> =-10V, V <sub>DS</sub> =-20V, I <sub>D</sub> =-20A		42	55	nC
Q <sub>g</sub> (-4.5V)	Total Gate Charge			18.6		
Q <sub>gs</sub>	Gate Source Charge			7		nC
Q <sub>gd</sub>	Gate Drain Charge			8.6		nC
t <sub>D(on)</sub>	Turn-On DelayTime	V <sub>GS</sub> =-10V, V <sub>DS</sub> =-20V, R <sub>L</sub> =1Ω, R <sub>GEN</sub> =3Ω		9.4		ns
t <sub>r</sub>	Turn-On Rise Time			20		ns
t <sub>D(off)</sub>	Turn-Off DelayTime			55		ns
t <sub>f</sub>	Turn-Off Fall Time			30		ns
t <sub>rr</sub>	Body Diode Reverse Recovery Time	I <sub>F</sub> =-20A, dI/dt=100A/μs		38	49	ns
Q <sub>rr</sub>	Body Diode Reverse Recovery Charge	I <sub>F</sub> =-20A, dI/dt=100A/μs		47		nC

A: The value of R<sub>θJA</sub> is measured with the device in a still air environment with T<sub>A</sub>=25° C. The power dissipation P<sub>DSM</sub> and current rating I<sub>DSM</sub> are based on T<sub>J(MAX)</sub>=150° C, using steady state junction-to-ambient thermal resistance.

B: The power dissipation P<sub>D</sub> is based on T<sub>J(MAX)</sub>=175° C, using junction-to-case thermal resistance, and is more useful in setting the upper dissipation limit for cases where additional heatsinking is used.

C: Repetitive rating, pulse width limited by junction temperature T<sub>J(MAX)</sub>=175° C.

D: The R<sub>θJA</sub> is the sum of the thermal impedance from junction to case R<sub>θJC</sub> and case to ambient.

E: The static characteristics in Figures 1 to 6 are obtained using <300 μs pulses, duty cycle 0.5% max.

F: These curves are based on the junction-to-case thermal impedance which is measured with the device mounted to a large heatsink, assuming a maximum junction temperature of T<sub>J(MAX)</sub>=175° C. The SOA curve provides a single pulse rating.

G: These tests are performed with the device mounted on 1 in<sup>2</sup> FR-4 board with 2oz. Copper, in a still air environment with T<sub>A</sub>=25° C.

H: The maximum current rating is limited by bond-wires.

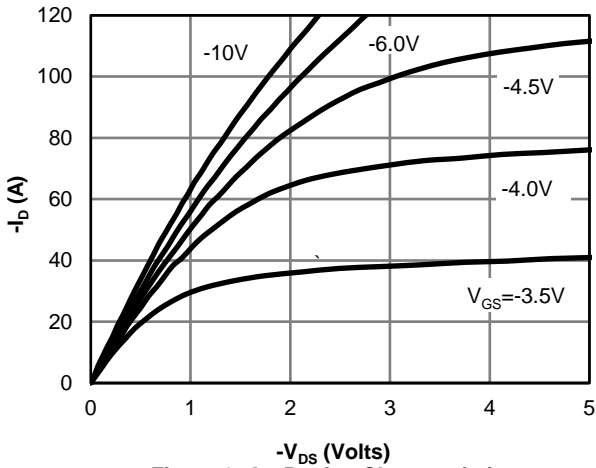
\*This device is guaranteed green after data code 8X11 (Sep 1<sup>ST</sup> 2008).

APPLICATIONS OR USES AS CRITICAL COMPONENTS IN LIFE SUPPORT DEVICES OR SYSTEMS ARE NOT AUTHORIZED. AOS DOES NOT ASSUME ANY LIABILITY ARISING OUT OF SUCH APPLICATIONS OR USES OF ITS PRODUCTS. AOS RESERVES THE RIGHT TO MAKE CHANGES TO PRODUCT SPECIFICATIONS WITHOUT NOTICE. IT IS THE RESPONSIBILITY OF THE CUSTOMER TO EVALUATE SUITABILITY OF THE PRODUCT FOR THEIR INTENDED APPLICATION. CUSTOMER SHALL COMPLY WITH APPLICABLE LEGAL REQUIREMENTS, INCLUDING ALL APPLICABLE EXPORT CONTROL RULES, REGULATIONS AND LIMITATIONS.

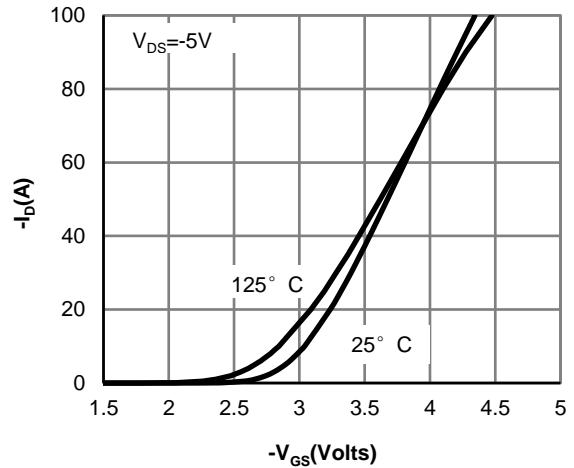
AOS' products are provided subject to AOS' terms and conditions of sale which are set forth at:

[http://www.aosmd.com/terms\\_and\\_conditions\\_of\\_sale](http://www.aosmd.com/terms_and_conditions_of_sale)

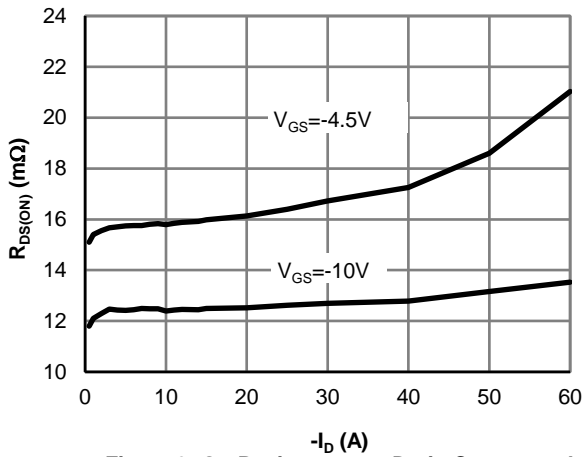
**TYPICAL ELECTRICAL AND THERMAL CHARACTERISTICS**



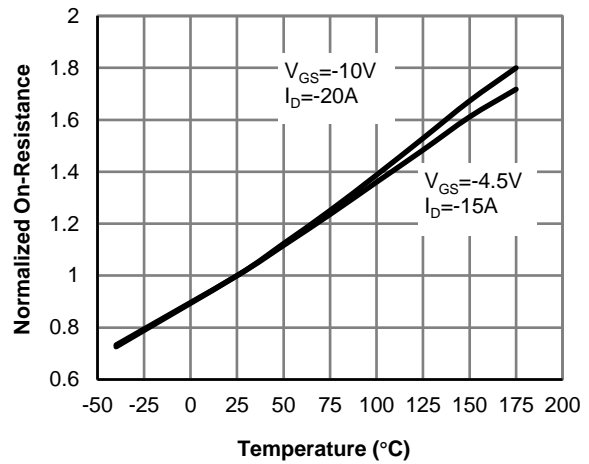
**Figure 1: On-Region Characteristics**



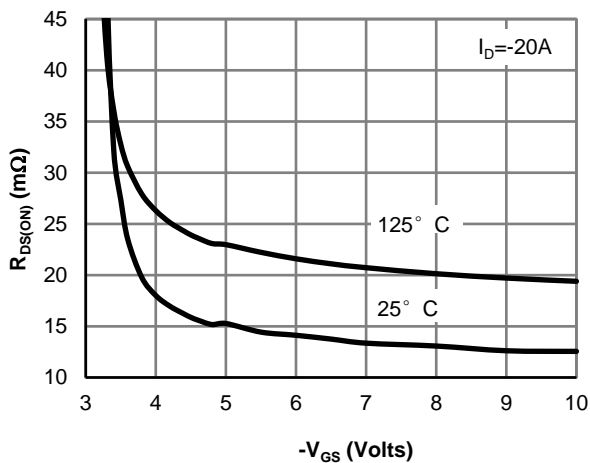
**Figure 2: Transfer Characteristics**



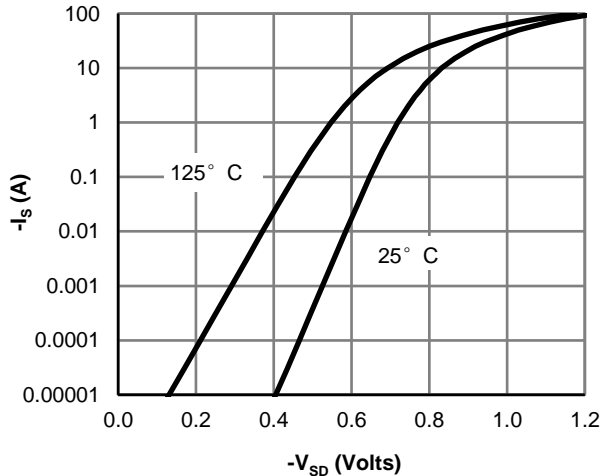
**Figure 3: On-Resistance vs. Drain Current and Gate Voltage**



**Figure 4: On-Resistance vs. Junction Temperature**

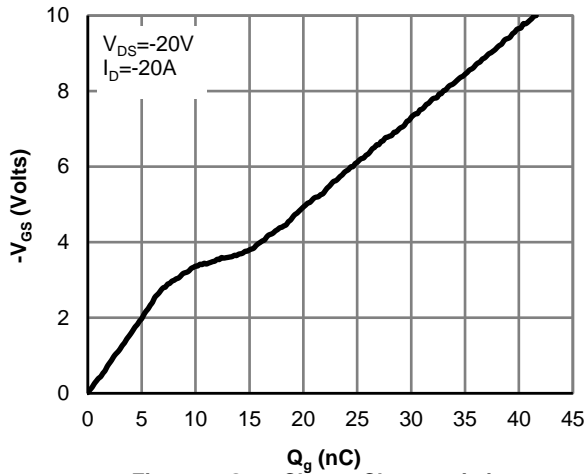


**Figure 5: On-Resistance vs. Gate-Source Voltage**

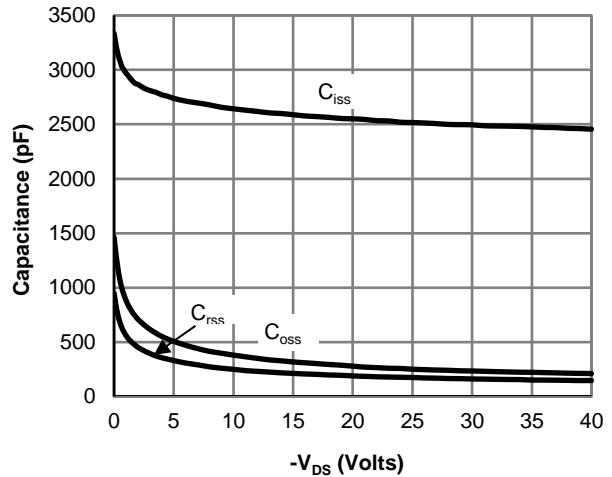


**Figure 6: Body-Diode Characteristics**

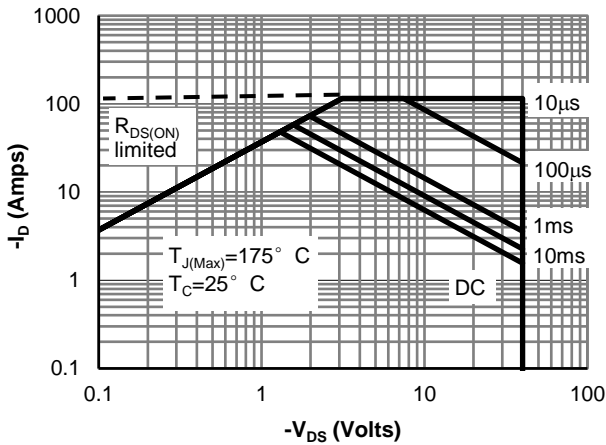
**TYPICAL ELECTRICAL AND THERMAL CHARACTERISTICS**



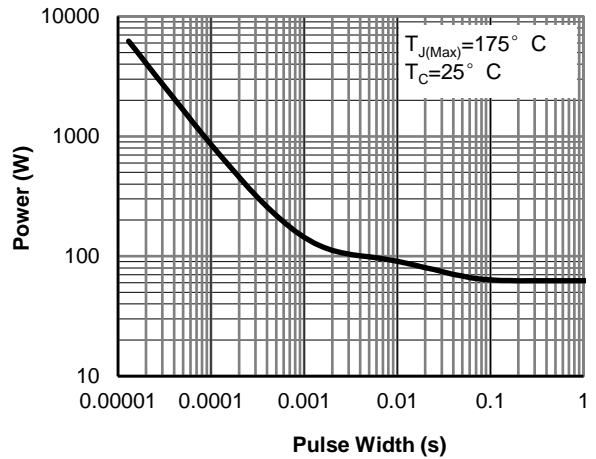
**Figure 7: Gate-Charge Characteristics**



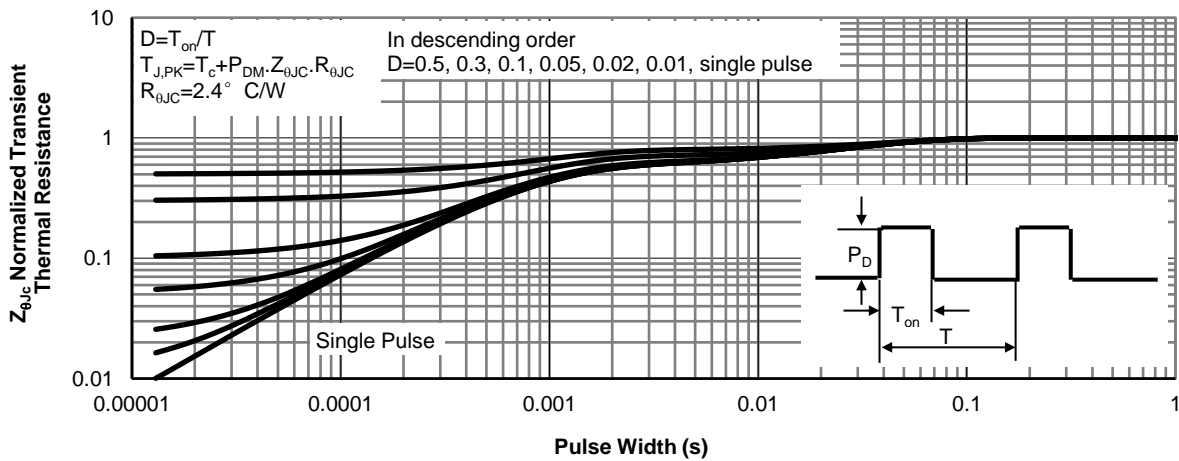
**Figure 8: Capacitance Characteristics**



**Figure 9: Maximum Forward Biased Safe Operating Area (Note F)**



**Figure 10: Single Pulse Power Rating Junction-to-Case (Note F)**



**Figure 11: Normalized Maximum Transient Thermal Impedance (Note F)**

**TYPICAL ELECTRICAL AND THERMAL CHARACTERISTICS**

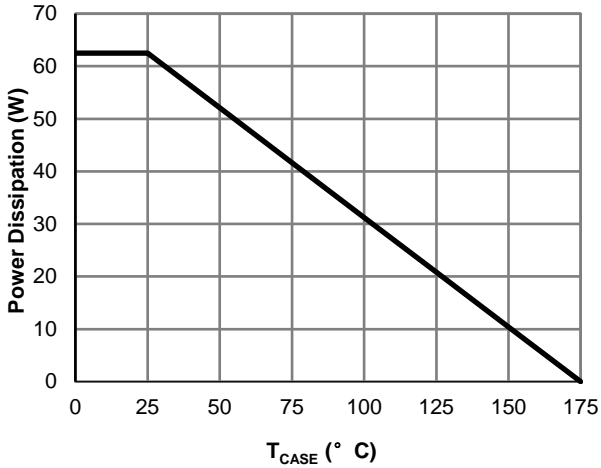


Figure 12: Power De-rating (Note B)

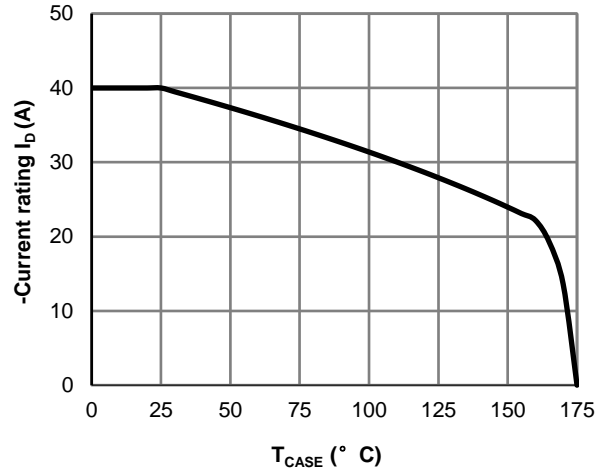


Figure 13: Current De-rating (Note B)

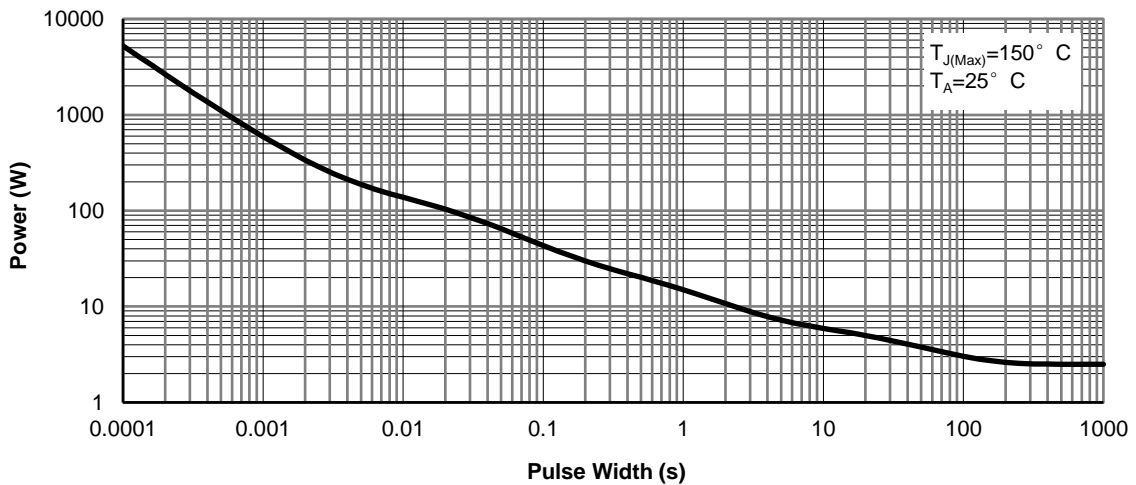


Figure 14: Single Pulse Power Rating Junction-to-Ambient (Note G)

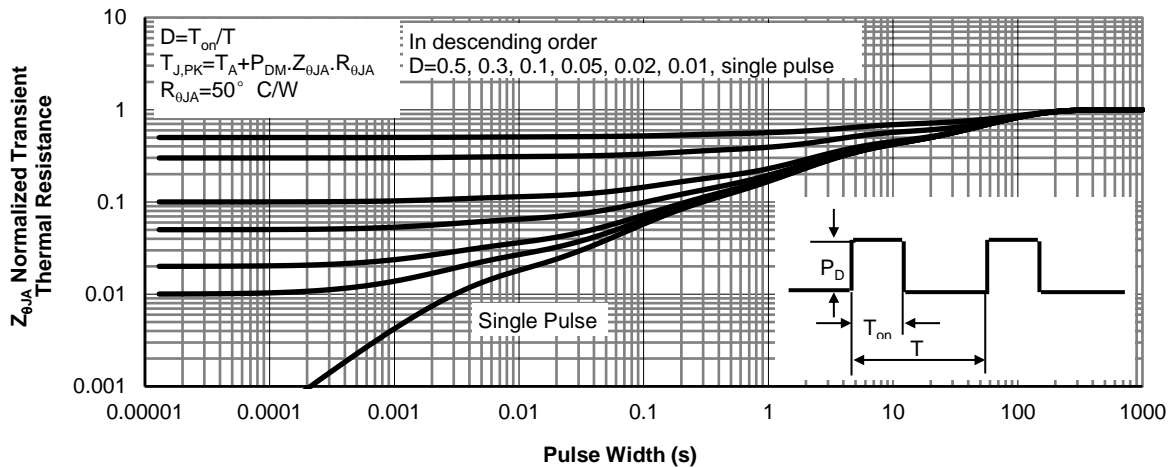
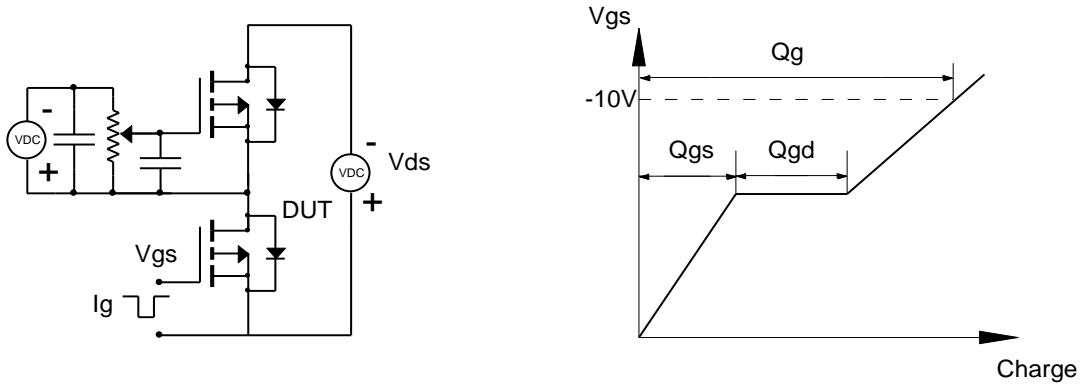
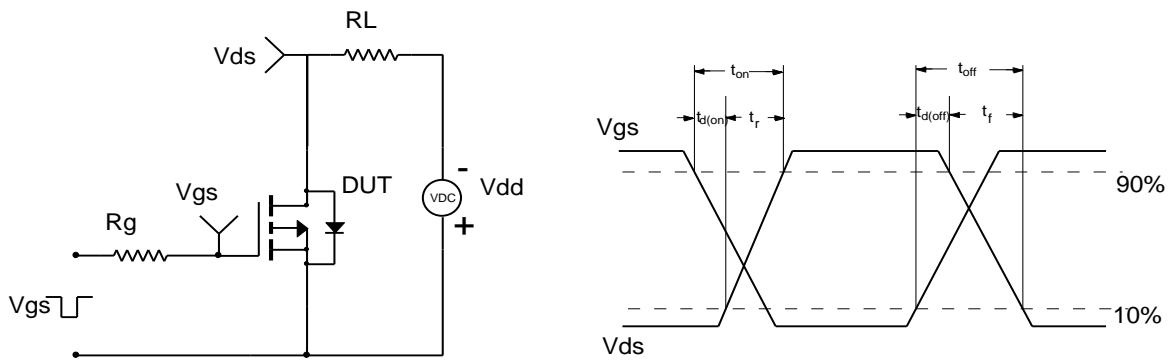


Figure 15: Normalized Maximum Transient Thermal Impedance (Note G)

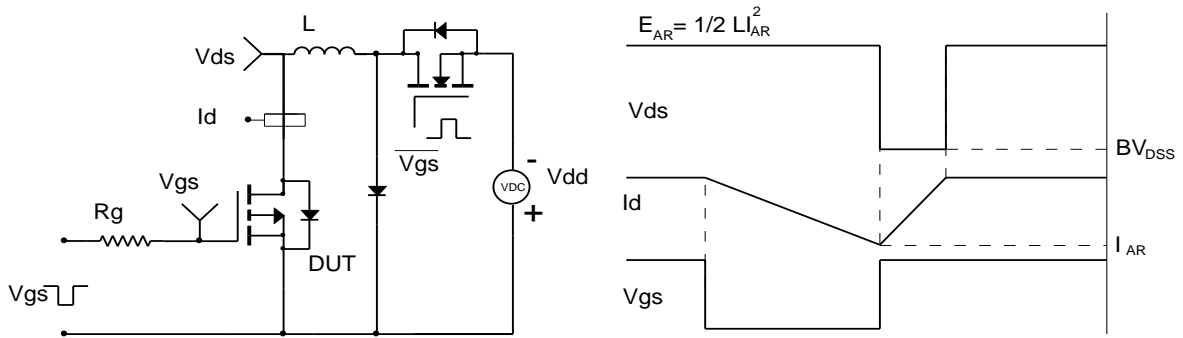
Gate Charge Test Circuit & Waveform



Resistive Switching Test Circuit & Waveforms



Unclamped Inductive Switching (UIS) Test Circuit & Waveforms



Diode Recovery Test Circuit & Waveforms

