

General Description

- Bottom Source Technology
- Very Low $R_{DS(ON)}$
- Low Gate Charge
- High Current Capability
- RoHS and Halogen-Free Compliant

Applications

- DC/DC Converters in Computing, Servers, and POL
- Non-Isolated DC/DC Converters in Telecom and Industrial

Product Summary

	Q1	Q2
V_{DS}	30V	30V
I_D (at $V_{GS}=10V$)	55A	85A
$R_{DS(ON)}$ (at $V_{GS}=10V$)	< 5m Ω	< 2m Ω
$R_{DS(ON)}$ (at $V_{GS}=4.5V$)	< 8m Ω	< 3m Ω

100% UIS Tested
 100% Rg Tested

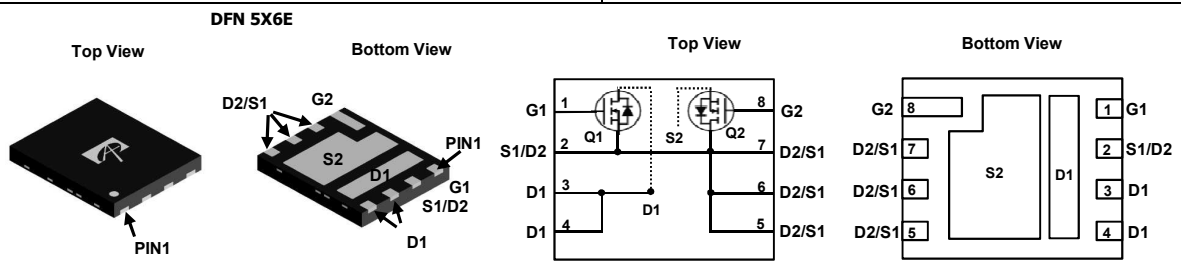

Orderable Part Number	Package Type	Form	Minimum Order Quantity
AOE6936	DFN 5x6E	Tape & Reel	3000

Absolute Maximum Ratings $T_A=25^\circ C$ unless otherwise noted

Parameter	Symbol	Max Q1	Max Q2	Units
Drain-Source Voltage	V_{DS}	30	30	V
Gate-Source Voltage	V_{GS}	± 20	± 20	V
Continuous Drain Current ^G	I_D	55	85	A
$T_C=100^\circ C$		35	67	
Pulsed Drain Current ^C	I_{DM}	120	208	A
Continuous Drain Current	I_{DSM}	21	32	A
$T_A=70^\circ C$		16	25	
Avalanche Current ^C	I_{AS}	60	80	A
Avalanche energy	E_{AS}	18	32	mJ
V_{DS} Spike	V_{SPIKE}	36	36	V
Power Dissipation ^B	P_D	24	39	W
		$T_C=100^\circ C$	9.6	
Power Dissipation ^A	P_{DSM}	3.5	3.5	W
		$T_A=70^\circ C$	2.2	
Junction and Storage Temperature Range	T_J, T_{STG}	-55 to 150		$^\circ C$

Thermal Characteristics

Parameter	Symbol	Typ Q1	Typ Q2	Max Q1	Max Q2	Units
Maximum Junction-to-Ambient ^A	$R_{\theta JA}$	25	25	35	35	$^\circ C/W$
Maximum Junction-to-Ambient ^{A,D}		Steady-State	50	50	65	
Maximum Junction-to-Case (Note)	$R_{\theta JC}$	4	2.4	5.2	3.2	$^\circ C/W$

Note: Bottom S2, D1.

Q1 Electrical Characteristics (T_J=25°C unless otherwise noted)

Symbol	Parameter	Conditions	Min	Typ	Max	Units
STATIC PARAMETERS						
BV _{DSS}	Drain-Source Breakdown Voltage	I _D =250μA, V _{GS} =0V	30			V
I _{DSS}	Zero Gate Voltage Drain Current	V _{DS} =30V, V _{GS} =0V T _J =55°C			1 5	μA
I _{GSS}	Gate-Body leakage current	V _{DS} =0V, V _{GS} =±20V			±100	nA
V _{GS(th)}	Gate Threshold Voltage	V _{DS} =V _{GS} , I _D =250μA	1.3	1.7	2.2	V
R _{DS(on)}	Static Drain-Source On-Resistance	V _{GS} =10V, I _D =20A T _J =125°C		3.5 5	5 7	mΩ
		V _{GS} =4.5V, I _D =20A		5.2	8	
g _{FS}	Forward Transconductance	V _{DS} =5V, I _D =20A		57		S
V _{SD}	Diode Forward Voltage	I _S =1A, V _{GS} =0V		0.7	1	V
I _S	Maximum Body-Diode Continuous Current				30	A
DYNAMIC PARAMETERS						
C _{iss}	Input Capacitance	V _{GS} =0V, V _{DS} =15V, f=1MHz		1150		pF
C _{oss}	Output Capacitance			380		pF
C _{rss}	Reverse Transfer Capacitance			55		pF
R _g	Gate resistance	f=1MHz	0.6	1.2	2.0	Ω
SWITCHING PARAMETERS						
Q _{g(10V)}	Total Gate Charge	V _{GS} =10V, V _{DS} =15V, I _D =20A		16	25	nC
Q _{g(4.5V)}	Total Gate Charge			7.5	15	nC
Q _{gs}	Gate Source Charge			2.5		nC
Q _{gd}	Gate Drain Charge			3.0		nC
Q _{gs}	Gate Source Charge	V _{GS} =4.5V, V _{DS} =15V, I _D =20A		2.5		nC
Q _{gd}	Gate Drain Charge			3.0		nC
t _{D(on)}	Turn-On DelayTime	V _{GS} =10V, V _{DS} =15V, R _L =0.75Ω, R _{GEN} =3Ω		6.5		ns
t _r	Turn-On Rise Time			4.5		ns
t _{D(off)}	Turn-Off DelayTime			19		ns
t _f	Turn-Off Fall Time			3		ns
t _{rr}	Body Diode Reverse Recovery Time	I _F =20A, dI/dt=500A/μs		11.5		ns
Q _{rr}	Body Diode Reverse Recovery Charge	I _F =20A, dI/dt=500A/μs		20		nC

A. The value of R_{θJA} is measured with the device mounted on 1 in² FR-4 board with 2oz. Copper, in a still air environment with T_A =25° C. The Power dissipation P_{DSM} is based on R_{θJA} ≤ 10s and the maximum allowed junction temperature of 150° C. The value in any given application depends on the user's specific board design.

B. The power dissipation P_D is based on T_{J(MAX)}=150° C, using junction-to-case thermal resistance, and is more useful in setting the upper dissipation limit for cases where additional heatsinking is used.

C. Single pulse width limited by junction temperature T_{J(MAX)}=150° C.

D. The R_{θJA} is the sum of the thermal impedance from junction to case R_{θJC} and case to ambient.

E. The static characteristics in Figures 1 to 6 are obtained using <300μs pulses, duty cycle 0.5% max.

F. These curves are based on the junction-to-case thermal impedance which is measured with the device mounted to a large heatsink, assuming a maximum junction temperature of T_{J(MAX)}=150° C. The SOA curve provides a single pulse rating.

G. The maximum current rating is package limited.

H. These tests are performed with the device mounted on 1 in² FR-4 board with 2oz. Copper, in a still air environment with T_A=25° C.

APPLICATIONS OR USE AS CRITICAL COMPONENTS IN LIFE SUPPORT DEVICES OR SYSTEMS ARE NOT AUTHORIZED. AOS DOES NOT ASSUME ANY LIABILITY ARISING OUT OF SUCH APPLICATIONS OR USES OF ITS PRODUCTS. AOS RESERVES THE RIGHT TO IMPROVE PRODUCT DESIGN,FUNCTIONS AND RELIABILITY WITHOUT NOTICE.

TYPICAL ELECTRICAL AND THERMAL CHARACTERISTICS

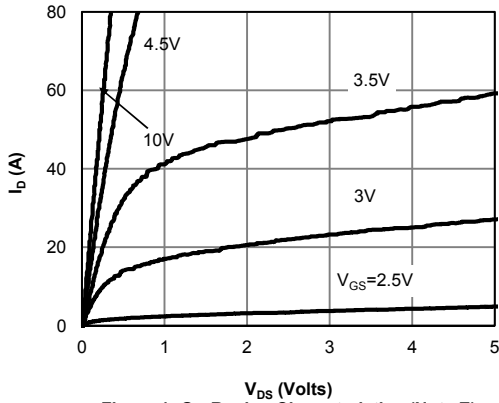

Figure 1: On-Region Characteristics (Note E)

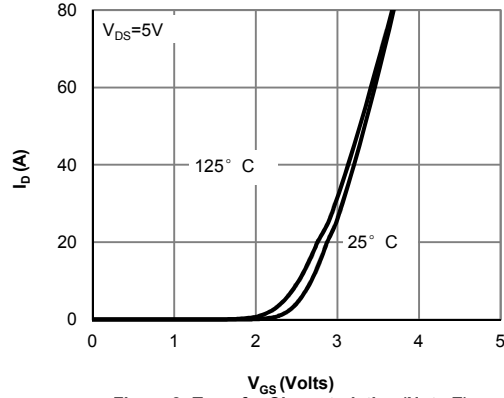

Figure 2: Transfer Characteristics (Note E)

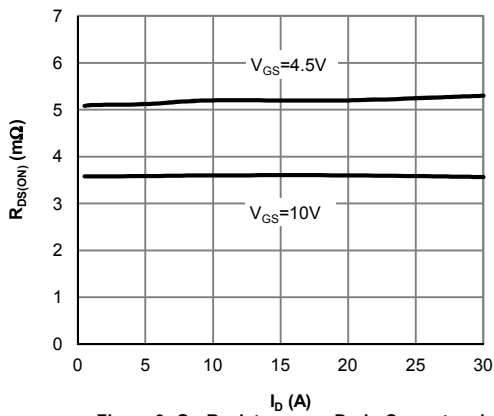

Figure 3: On-Resistance vs. Drain Current and Gate Voltage (Note E)

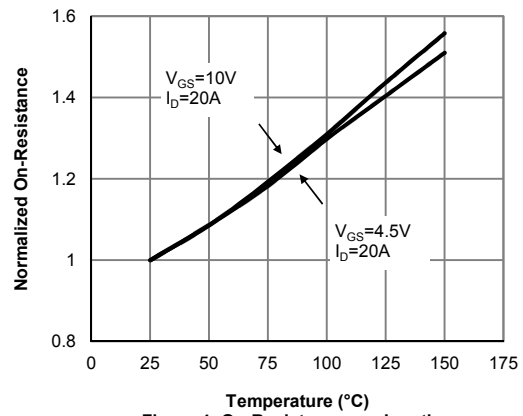

Figure 4: On-Resistance vs. Junction Temperature (Note E)

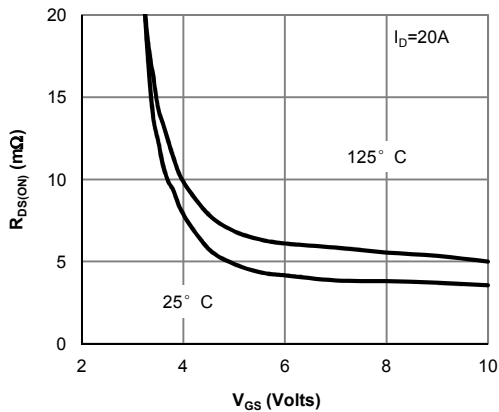

Figure 5: On-Resistance vs. Gate-Source Voltage (Note E)

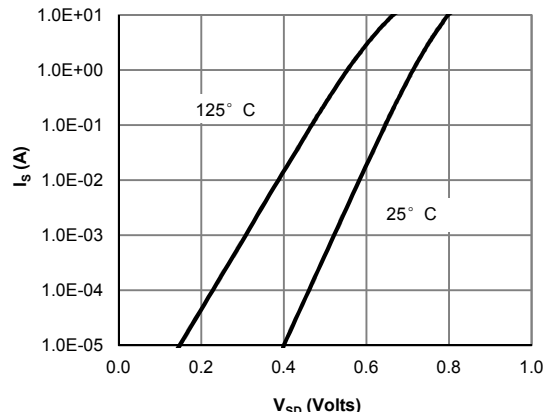

Figure 6: Body-Diode Characteristics (Note E)

TYPICAL ELECTRICAL AND THERMAL CHARACTERISTICS

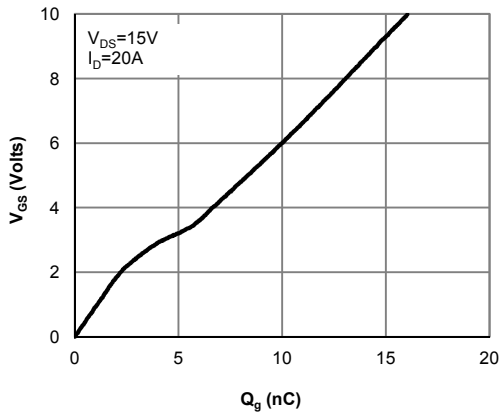

Figure 7: Gate-Charge Characteristics

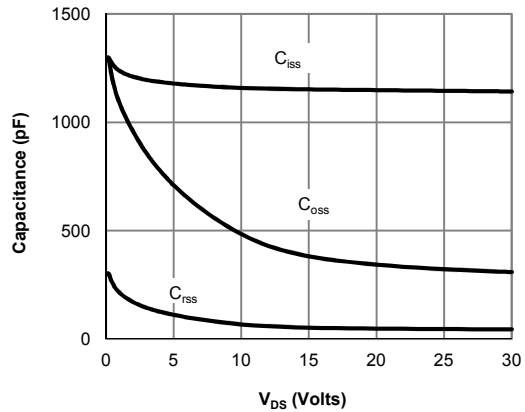

Figure 8: Capacitance Characteristics

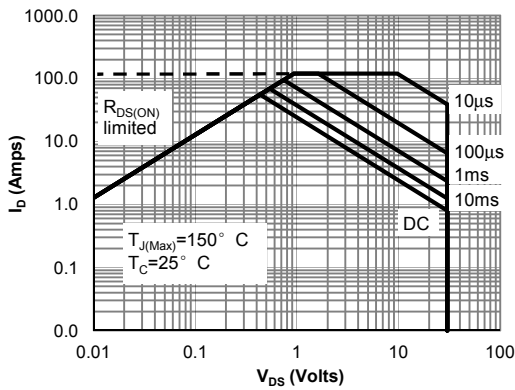

Figure 9: Maximum Forward Biased Safe Operating Area (Note F)

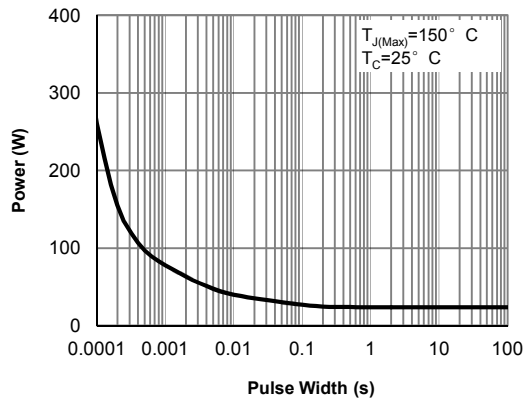

Figure 10: Single Pulse Power Rating Junction-to-Case (Note F)

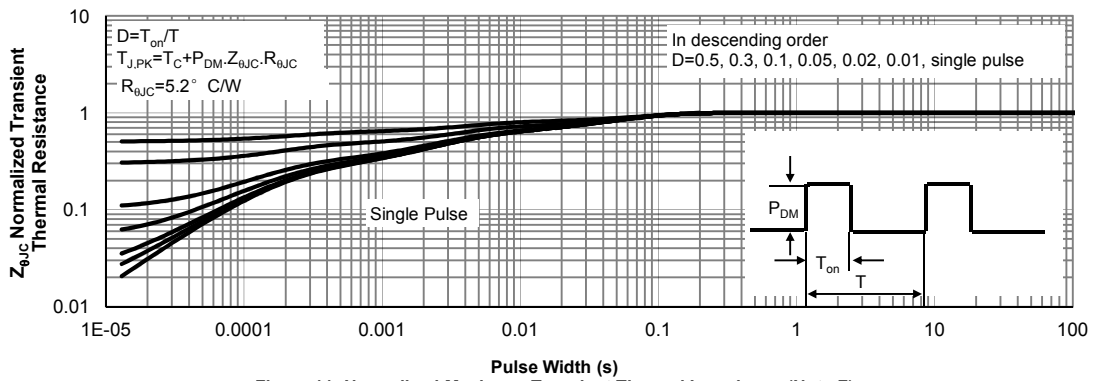
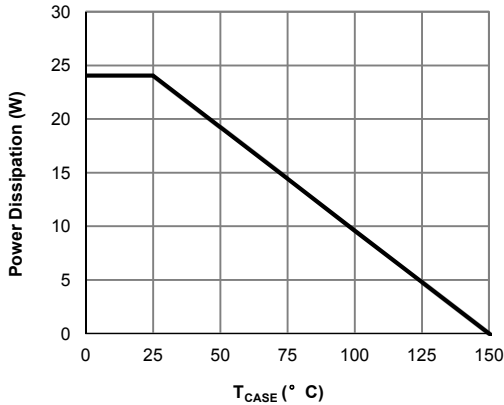
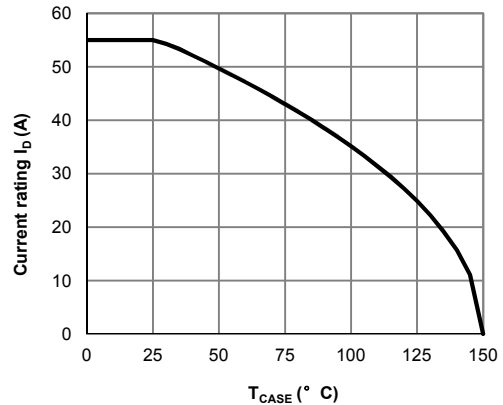
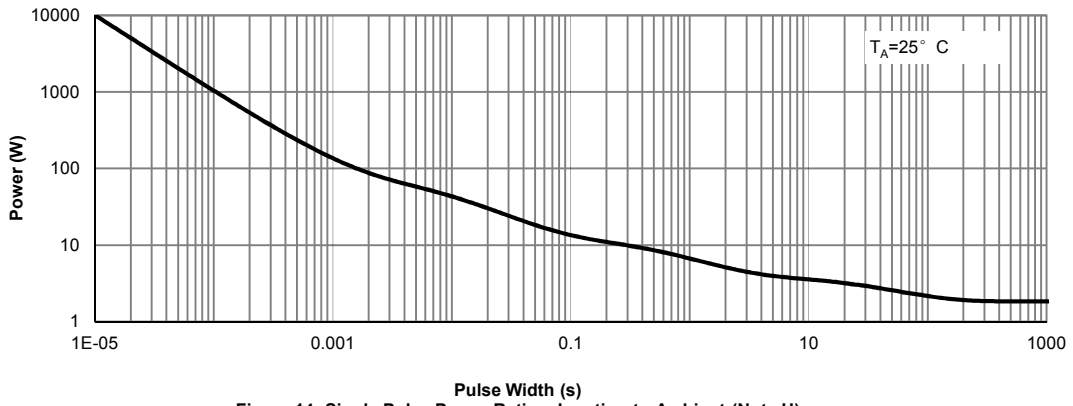
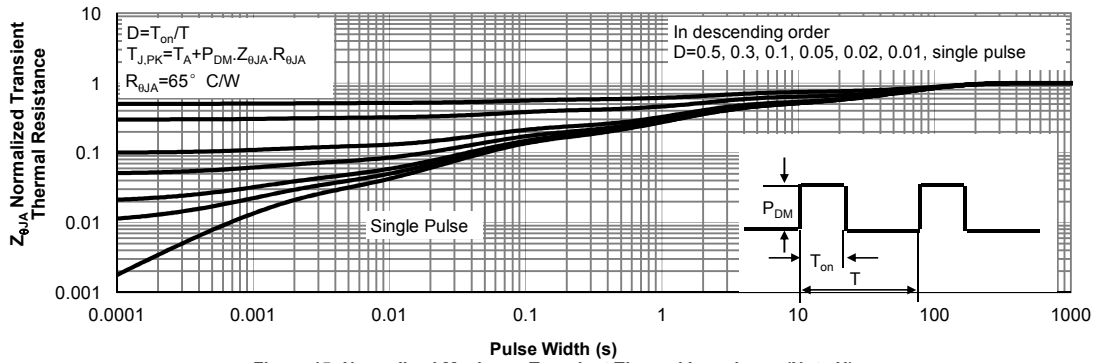

Figure 11: Normalized Maximum Transient Thermal Impedance (Note F)

TYPICAL ELECTRICAL AND THERMAL CHARACTERISTICS

Figure 12: Power De-rating (Note F)

Figure 13: Current De-rating (Note F)

Figure 14: Single Pulse Power Rating Junction-to-Ambient (Note H)

Figure 15: Normalized Maximum Transient Thermal Impedance (Note H)

Q2 Electrical Characteristics (T_J=25°C unless otherwise noted)

Symbol	Parameter	Conditions	Min	Typ	Max	Units
STATIC PARAMETERS						
BV _{DSS}	Drain-Source Breakdown Voltage	I _D =250μA, V _{GS} =0V	30			V
I _{DSS}	Zero Gate Voltage Drain Current	V _{DS} =30V, V _{GS} =0V T _J =55°C			1 5	μA
I _{GSS}	Gate-Body leakage current	V _{DS} =0V, V _{GS} =±20V			±100	nA
V _{GS(th)}	Gate Threshold Voltage	V _{DS} =V _{GS} , I _D =250μA	1.2	1.6	2.1	V
R _{DS(on)}	Static Drain-Source On-Resistance	V _{GS} =10V, I _D =20A T _J =125°C		1.5	2	mΩ
		V _{GS} =4.5V, I _D =20A		2.3	3	
g _{FS}	Forward Transconductance	V _{DS} =5V, I _D =20A		110		S
V _{SD}	Diode Forward Voltage	I _S =1A, V _{GS} =0V		0.7	1	V
I _S	Maximum Body-Diode Continuous Current				50	A
DYNAMIC PARAMETERS						
C _{iss}	Input Capacitance	V _{GS} =0V, V _{DS} =15V, f=1MHz		2270		pF
C _{oss}	Output Capacitance			650		pF
C _{riss}	Reverse Transfer Capacitance			90		pF
R _g	Gate resistance	f=1MHz	0.7	1.4	2.5	Ω
SWITCHING PARAMETERS						
Q _{g(10V)}	Total Gate Charge	V _{GS} =10V, V _{DS} =15V, I _D =20A		31.5	50	nC
Q _{g(4.5V)}	Total Gate Charge			15	25	nC
Q _{gs}	Gate Source Charge			5.5		nC
Q _{gd}	Gate Drain Charge			4.5		nC
Q _{gs}	Gate Source Charge	V _{GS} =4.5V, V _{DS} =15V, I _D =20A		5.5		nC
Q _{gd}	Gate Drain Charge			4.5		nC
t _{D(on)}	Turn-On DelayTime	V _{GS} =10V, V _{DS} =15V, R _L =0.75Ω, R _{GEN} =3Ω		6.5		ns
t _r	Turn-On Rise Time			5.5		ns
t _{D(off)}	Turn-Off DelayTime			27		ns
t _f	Turn-Off Fall Time			5.5		ns
t _{rr}	Body Diode Reverse Recovery Time	I _F =20A, dI/dt=500A/μs		14.5		ns
Q _{rr}	Body Diode Reverse Recovery Charge	I _F =20A, dI/dt=500A/μs		30		nC

A. The value of R_{θJA} is measured with the device mounted on 1 in² FR-4 board with 2oz. Copper, in a still air environment with T_A =25° C. The Power dissipation P_{DSM} is based on R_{θJA} ≤ 10s and the maximum allowed junction temperature of 150° C. The value in any given application depends on the user's specific board design.

B. The power dissipation P_D is based on T_{J(MAX)}=150° C, using junction-to-case thermal resistance, and is more useful in setting the upper dissipation limit for cases where additional heatsinking is used.

C. Single pulse width limited by junction temperature T_{J(MAX)}=150° C.

D. The R_{θJA} is the sum of the thermal impedance from junction to case R_{θJC} and case to ambient.

E. The static characteristics in Figures 1 to 6 are obtained using <300μs pulses, duty cycle 0.5% max.

F. These curves are based on the junction-to-case thermal impedance which is measured with the device mounted to a large heatsink, assuming a maximum junction temperature of T_{J(MAX)}=150° C. The SOA curve provides a single pulse rating.

G. The maximum current rating is package limited.

H. These tests are performed with the device mounted on 1 in² FR-4 board with 2oz. Copper, in a still air environment with T_A=25° C.

APPLICATIONS OR USE AS CRITICAL COMPONENTS IN LIFE SUPPORT DEVICES OR SYSTEMS ARE NOT AUTHORIZED. AOS DOES NOT ASSUME ANY LIABILITY ARISING OUT OF SUCH APPLICATIONS OR USES OF ITS PRODUCTS. AOS RESERVES THE RIGHT TO IMPROVE PRODUCT DESIGN,FUNCTIONS AND RELIABILITY WITHOUT NOTICE.

TYPICAL ELECTRICAL AND THERMAL CHARACTERISTICS

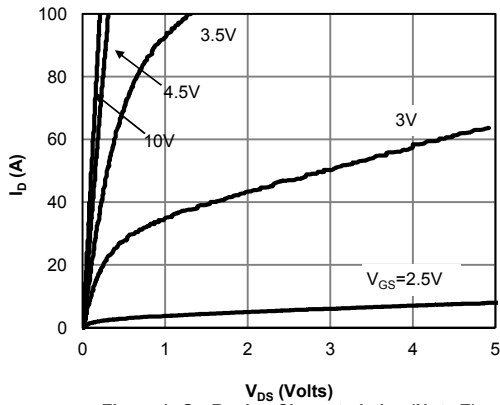

Figure 1: On-Region Characteristics (Note E)

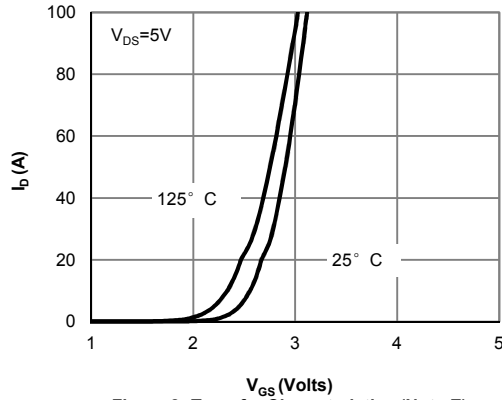

Figure 2: Transfer Characteristics (Note E)

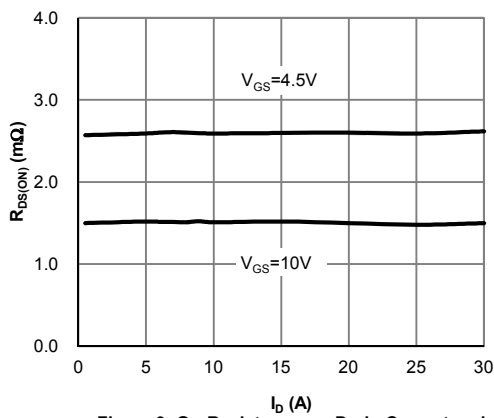

Figure 3: On-Resistance vs. Drain Current and Gate Voltage (Note E)

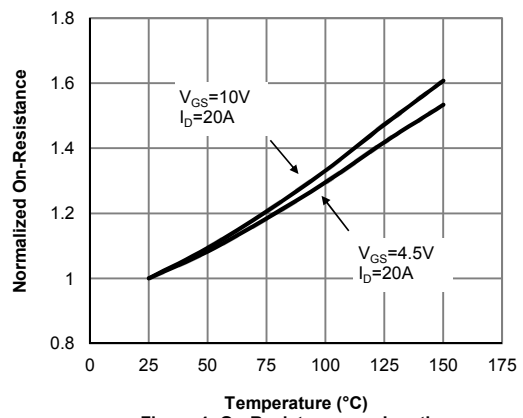

Figure 4: On-Resistance vs. Junction Temperature (Note E)

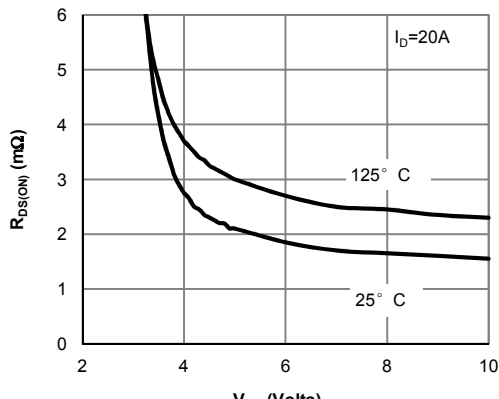

Figure 5: On-Resistance vs. Gate-Source Voltage (Note E)

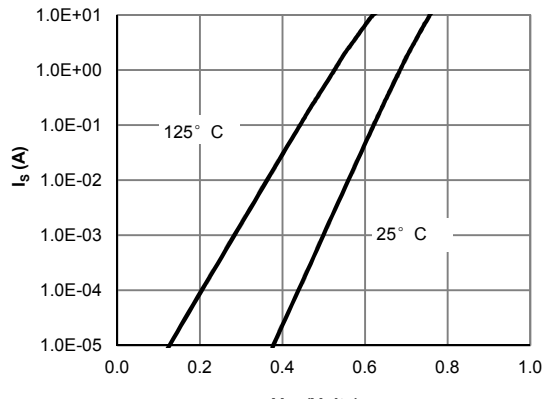

Figure 6: Body-Diode Characteristics (Note E)

TYPICAL ELECTRICAL AND THERMAL CHARACTERISTICS

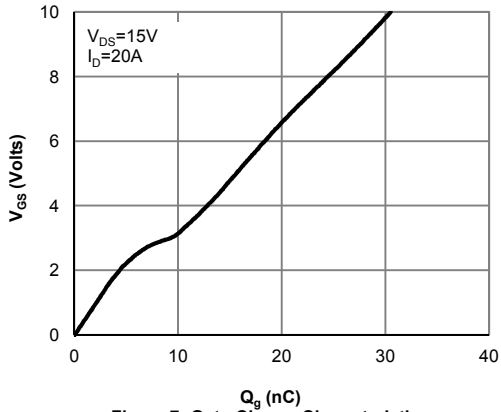

Figure 7: Gate-Charge Characteristics

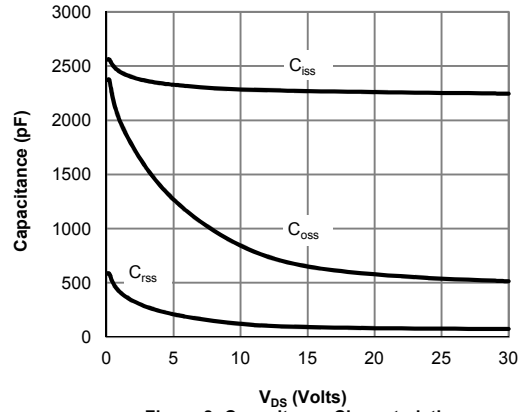

Figure 8: Capacitance Characteristics

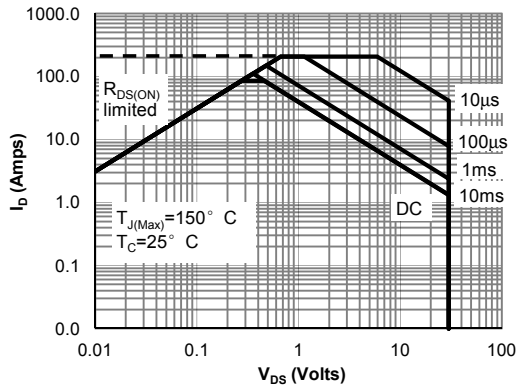

Figure 9: Maximum Forward Biased Safe Operating Area (Note F)

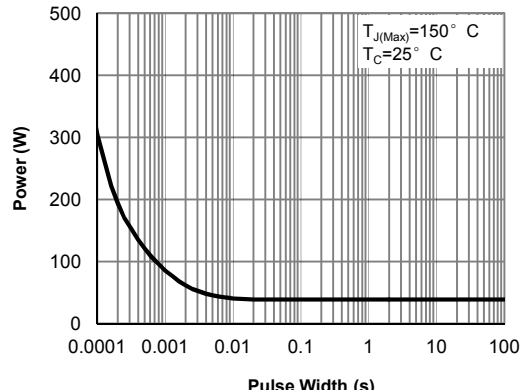

Figure 10: Single Pulse Power Rating Junction-to-Case (Note F)

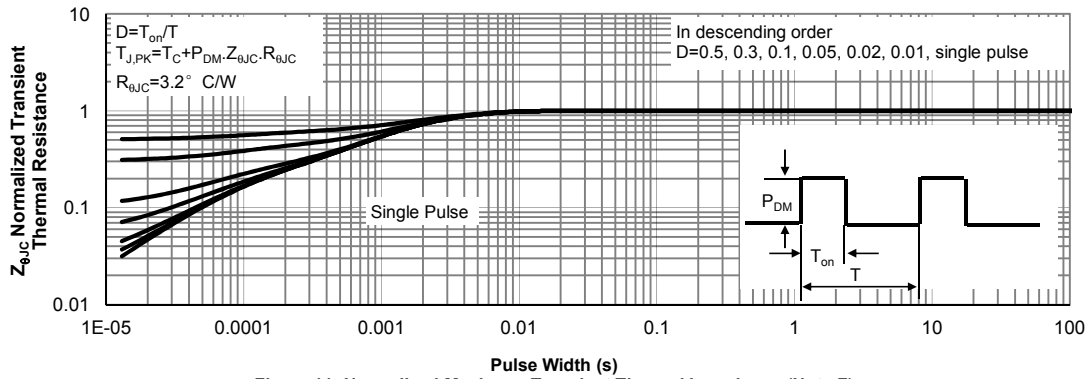

Figure 11: Normalized Maximum Transient Thermal Impedance (Note F)

TYPICAL ELECTRICAL AND THERMAL CHARACTERISTICS

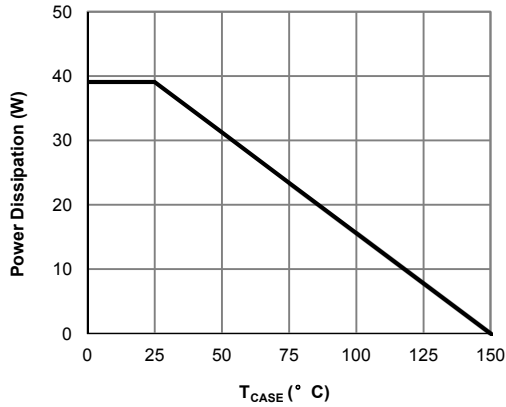

Figure 12: Power De-rating (Note F)

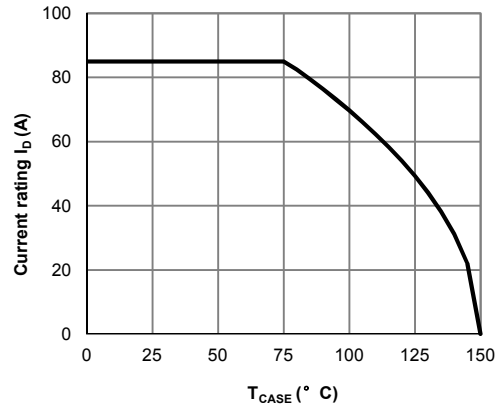

Figure 13: Current De-rating (Note F)

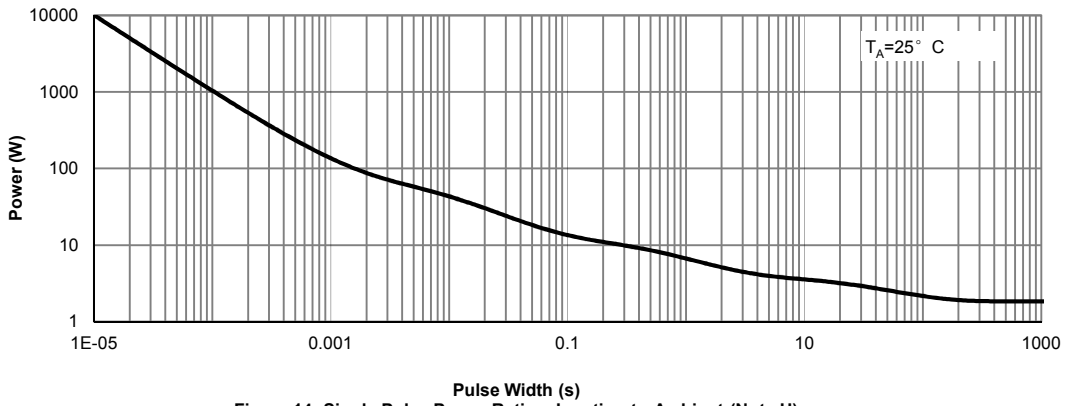

Figure 14: Single Pulse Power Rating Junction-to-Ambient (Note H)

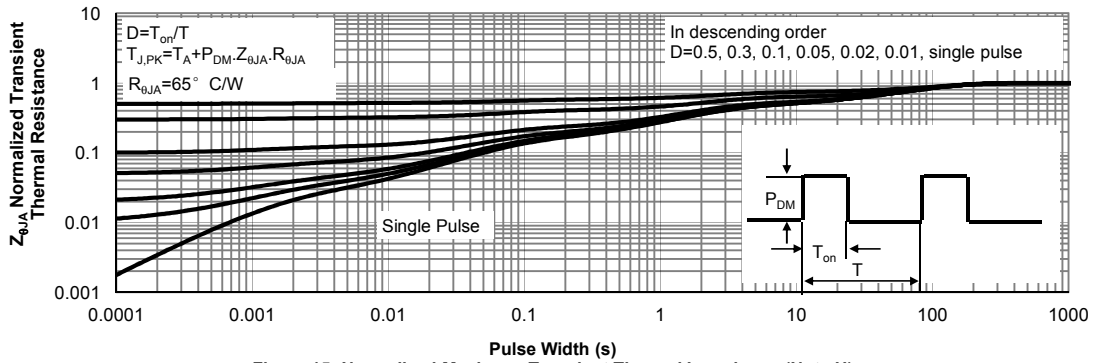

Figure 15: Normalized Maximum Transient Thermal Impedance (Note H)

Figure A: Gate Charge Test Circuit & Waveforms

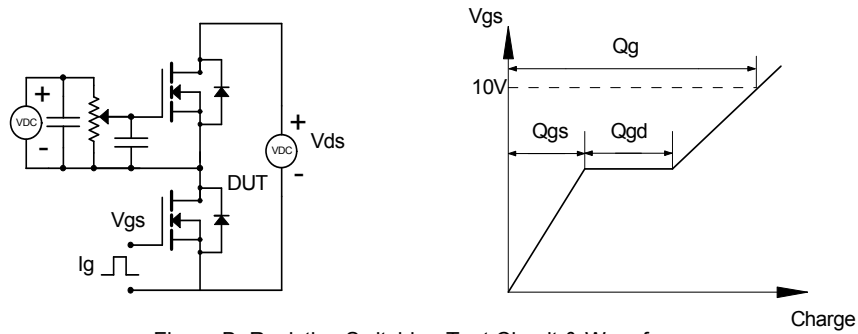

Figure B: Resistive Switching Test Circuit & Waveforms

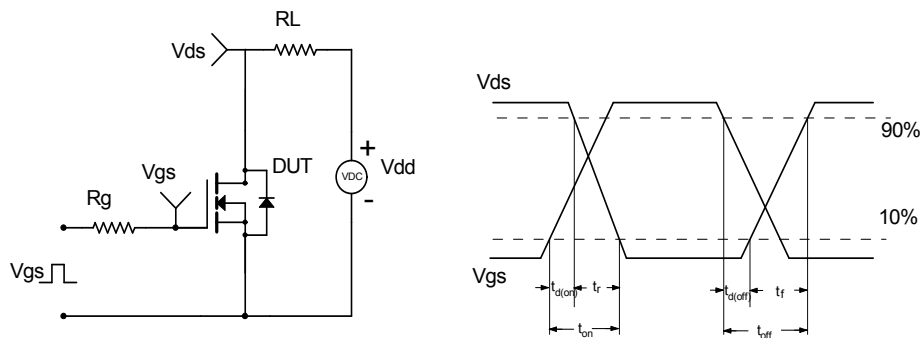

Figure C: Unclamped Inductive Switching (UIS) Test Circuit & Waveforms

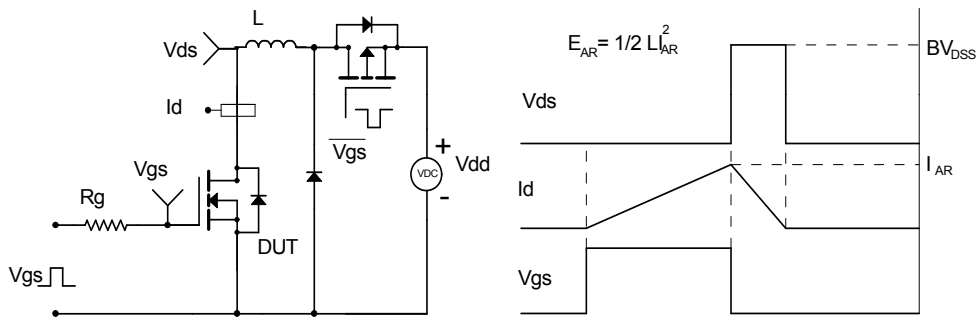

Figure D: Diode Recovery Test Circuit & Waveforms

