

Features

- Proprietary α SiC MOSFET technology
- Low loss, fast switching speeds with low R_G
- Optimized drive voltage ($V_{GS} = 15V$) for broad driver compatibility
- Robust body diode and low Q_{rr}

Applications

- Renewable
- EV Charger
- Solar Inverters
- Industrial
- UPS
- SMPS
- Motor Drives



Product Summary

$V_{DS} @ T_{J, max}$	650V
I_{DM}	85A
$R_{DS(ON), typ}$	65m Ω
Q_{rr}	104nC
$E_{OSS} @ 400V$	11 μ J
100% UIS Tested	

Pin Configuration

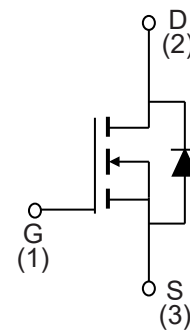
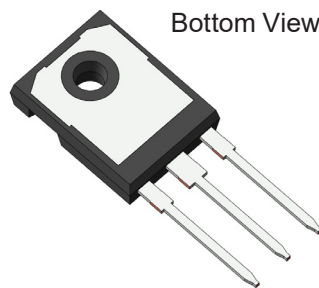
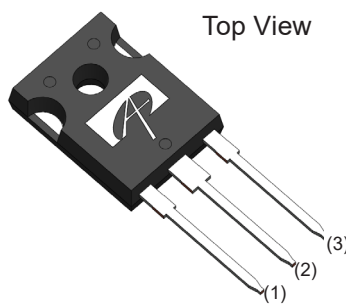

Ordering Part Number	Package Type	Form	Shipping Quantity
AOK065V65X2	TO-247-3L	Tube	30/Tube

Absolute Maximum Ratings

$T_A = 25^\circ C$, unless otherwise noted

Symbol	Parameter	AOK065V120X2	Units
V_{DS}	Drain-Source Voltage	650	V
$V_{GS, MAX}$	Gate-Source Voltage	Maximum	-8/+18
$V_{GS, OP, TRANS}$		Max Transient ^(A)	-8/+20
$V_{GS, OP}$		Recommended Operating ^(B)	-5/+15
I_D	Continuous Drain Current	$T_C = 25^\circ C$	40.3
		$T_C = 100^\circ C$	29.6
I_{DM}	Pulsed Drain Current ^(C)	85	A
E_{AS}	Single Pulsed Avalanche Energy ^(D)	250	mJ
P_D	Power Dissipation ^(C)	187.5	W
T_J, T_{STG}	Junction and Storage Temperature Range	-55 to 175	$^\circ C$
T_L	Maximum lead temperature for soldering purpose, 1/8" from case for 5 seconds	300	$^\circ C$

Thermal Characteristics

Symbol	Parameter	AOK065V120X2	Units
R _{θJA}	Maximum Junction-to-Ambient ^(E,F)	40	°C/W
R _{θJC}	Maximum Junction-to-Case ^(G)	0.8	°C/W

Electrical Characteristics

T_A = 25°C, unless otherwise noted

Symbol	Parameter	Conditions	Min	Typ	Max	Units	
STATIC							
V _{(BR)DSS}	Drain-Source Breakdown Voltage	I _D =250μA, V _{GS} =0V, T _J =25°C	650			V	
		I _D =250μA, V _{GS} =0V, T _J =150°C		650		V	
I _{DSS}	Zero Gate Voltage Drain Current	V _{DS} =650V, V _{GS} =0V			50	μA	
I _{GSS}	Gate-Source Leakage Current	V _{DS} =0V, V _{GS} =+15/-5V			±100	nA	
V _{GS(th)}	Gate Threshold Voltage	V _{DS} =V _{GS} , I _D =10mA	1.8	2.8	3.5	V	
R _{DS(ON)}	Static Drain-Source On-Resistance	V _{GS} =15V, I _D =10A	T _J = 25°C	65	85	mΩ	
			T _J = 150°C	90		mΩ	
g _{fs}	Forward Transconductance	V _{DS} =20V, I _D =20V		12		S	
V _{SD}	Diode Forward Voltage	I _S =10A, V _{GS} =-5V		4.1	5	V	
DYNAMIC							
C _{iss}	Input Capacitance	V _{GS} =0V, V _{DS} =400V, f=1MHz		1733		pF	
C _{oss}	Output Capacitance			98		pF	
C _{rss}	Reverse Transfer Capacitance			5.8		pF	
E _{oss}	Coss Stored Energy			11		μJ	
R _G	Gate Resistance	f=1MHz	0.9	1.7	2.5	Ω	
SWITCHING							
Q _g	Total Gate Charge	V _{GS} =-5/+15V, V _{DS} =400V, I _D =20A		58.8		nC	
Q _{gs}	Gate Source Charge			24.6		nC	
Q _{gd}	Gate Drain Charge			19.7		nC	
t _{d(on)}	Turn-On Delay Time	V _{GS} =0V/+15V, V _{DS} =400V, I _D =20A, R _G =2.5Ω		10.4		ns	
t _r	Turn-On Rise Time			25.5		ns	
t _{d(off)}	Turn-Off Delay Time			12.4		ns	
t _f	Turn-Off Fall Time			3.9		ns	
E _{on}	Turn-On Energy		La = 120μH		131.5		μJ
E _{off}	Turn-Off Energy		FWD: AOK065V65X2		8.9		μJ
E _{tot}	Total Switching Energy			140.4		μJ	
t _{rr}	Body Diode Reverse Recovery Time	I _F =13.2A, dI/dt=1200A/μs, V _{DS} =400V=33ns		33		ns	
I _{rm}	Peak Reverse Recovery Current	I _F =13.2A, dI/dt=750A/μs, V _{DS} =400V=6.4A		6.4		A	
Q _{rr}	Body Diode Reverse Recovery Charge	I _F =13.2A, dI/dt=750A/μs, V _{DS} =400V=104nC		104		nC	

Notes:

- A. < 1% duty cycle, f > 1Hz
 B. Device can be operated at V_{GS}=0/15V. Actual operating V_{GS} will depend on application specifics such as parasitic inductance and dV/dt but should not exceed maximum ratings.
 C. The power dissipation P_D is based on T_{J(MAX)}=175°C, using junction-to-case thermal resistance, and is more useful in setting the upper dissipation limit for cases where additional heatsinking is used.
 D. L=5mH, I_{AS}=4.3A, R_G=25Ω, Starting T_J=25°C.
 E. The value of R_{θJA} is measured with the device in a still air environment with T_A=25°C.

- F. The R_{θJA} is the sum of the thermal impedance from junction to case R_{θJC} and case to ambient.
 G. The value of R_{θJC} is measured with the device mounted to a large heatsink, assuming a maximum junction temperature of T_{J(MAX)}=175°C.
 H. The static characteristics in Figures 1 to 8 are obtained using <300ms pulses, duty cycle 0.5% max.
 I. These curves are based on R_{θJC} which is measured with the device mounted to a large heatsink, assuming a maximum junction temperature of T_{J(MAX)}=175°C. The SOA curve provides a single pulse rating.

Typical Electrical and Thermal Characteristics

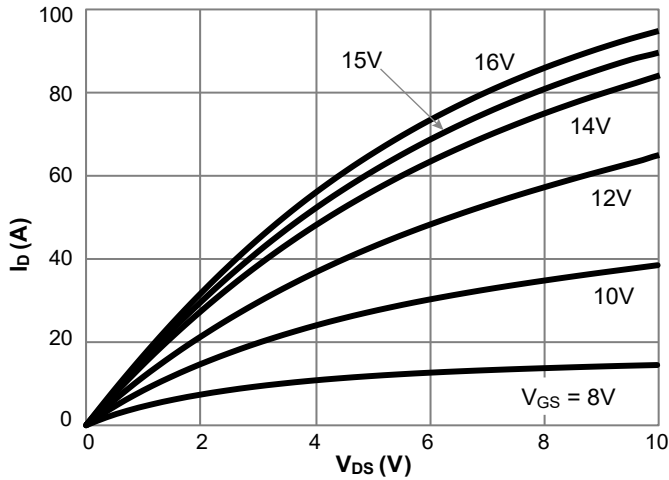

Figure 1. On-Region Characteristics $T_J = 25^\circ\text{C}$

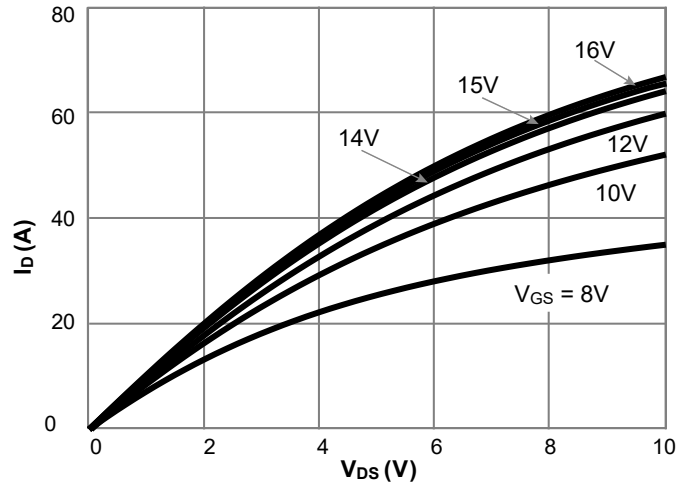

Figure 2. On-Region Characteristics $T_J = 175^\circ\text{C}$

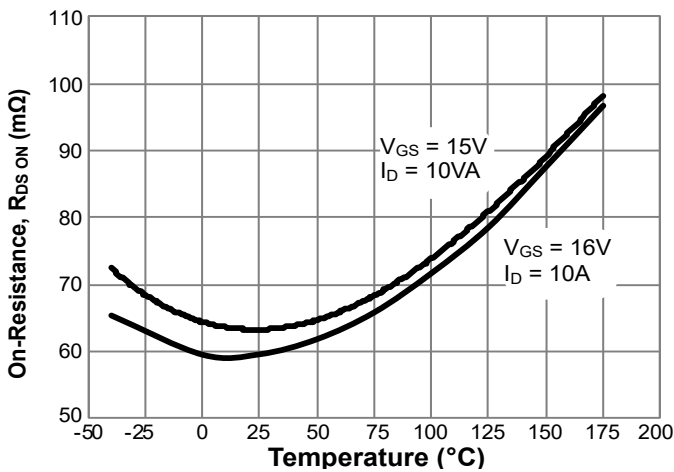

Figure 3. On-Resistance vs. Junction Temperature

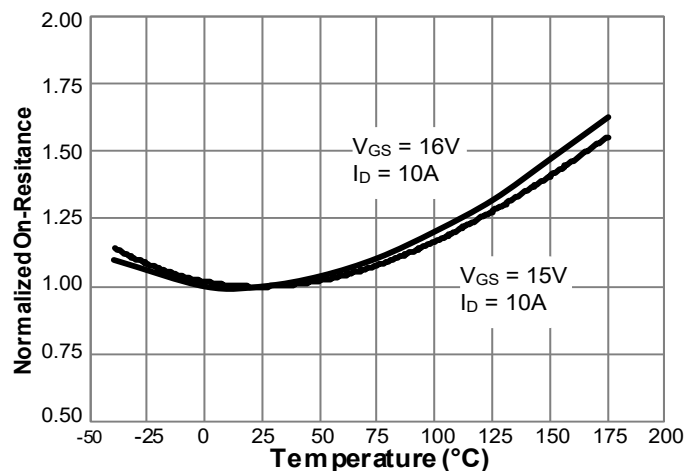

Figure 4. Normalized On-Resistance vs. Junction Temperature

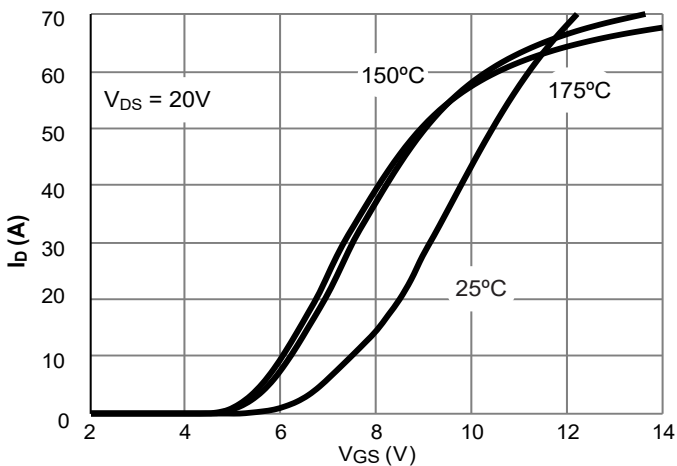

Figure 5. Transfer Characteristics

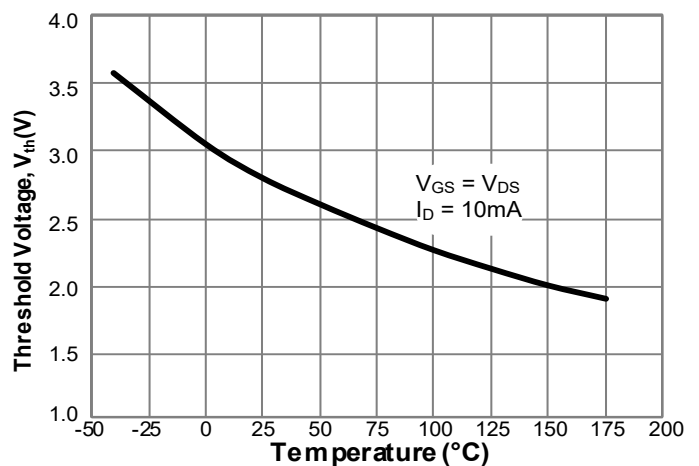

Figure 6. Threshold Voltage vs. Junction Temperature

Typical Electrical and Thermal Characteristics

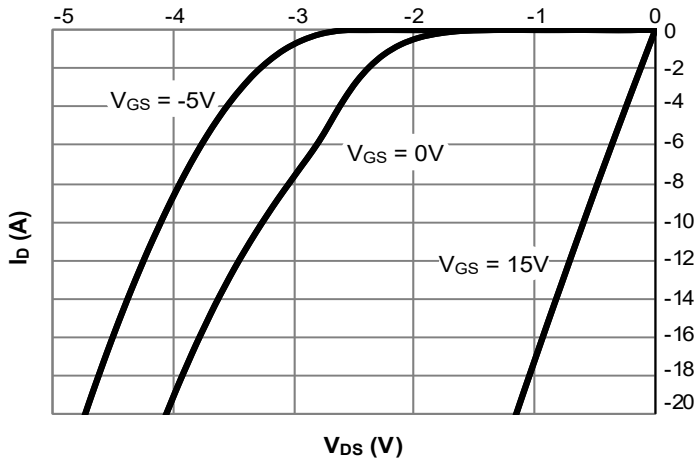

Figure 7. Body-Diode Characteristics at 25°C

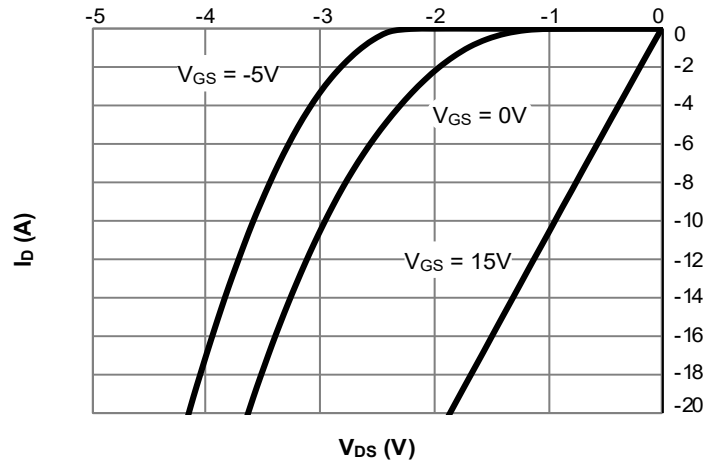

Figure 8. Body-Diode Characteristics at 175°C

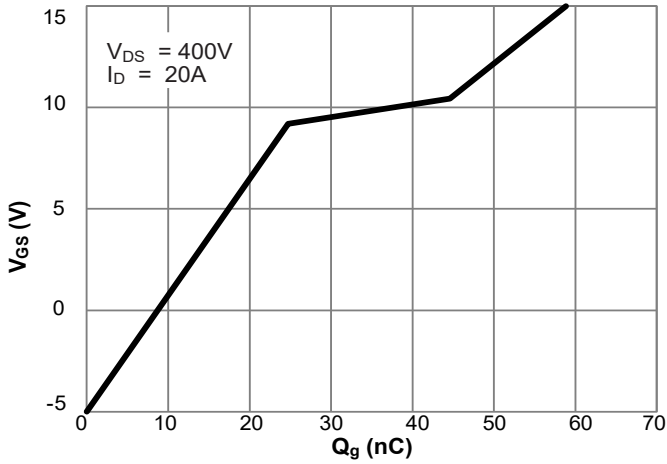

Figure 9. Gate-Charge Characteristics

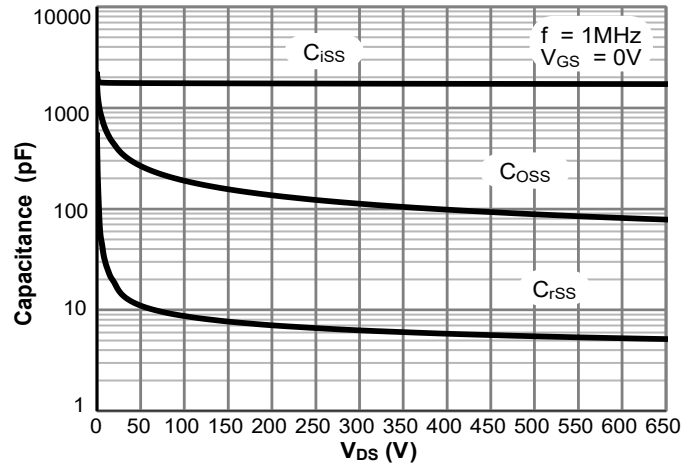

Figure 10. Capacitance Characteristics

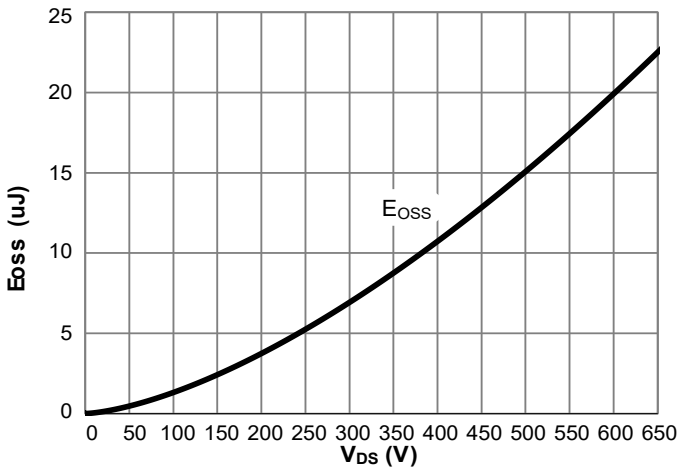

Figure 11. Coss Stored Energy

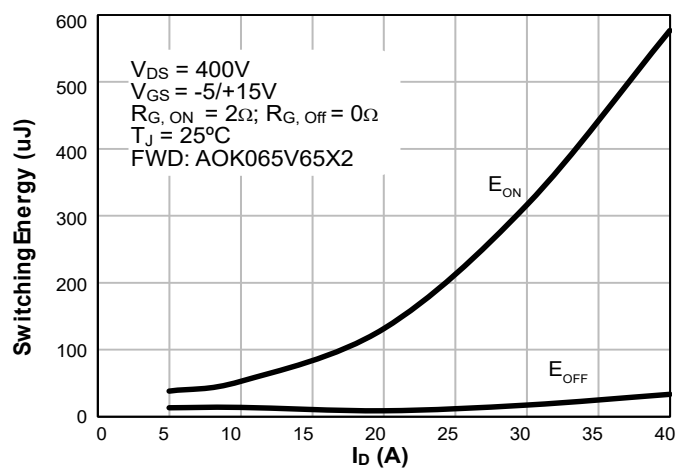

Figure 12. Switching Energy vs. Drain Current

Typical Electrical and Thermal Characteristics

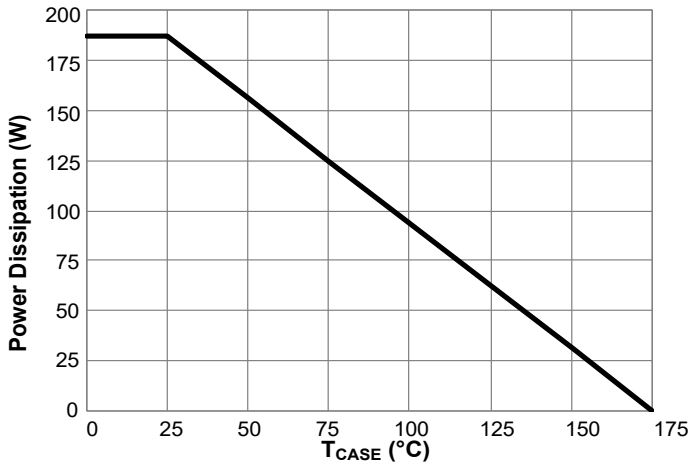

Figure 13. Switching Energy vs. Drain Current

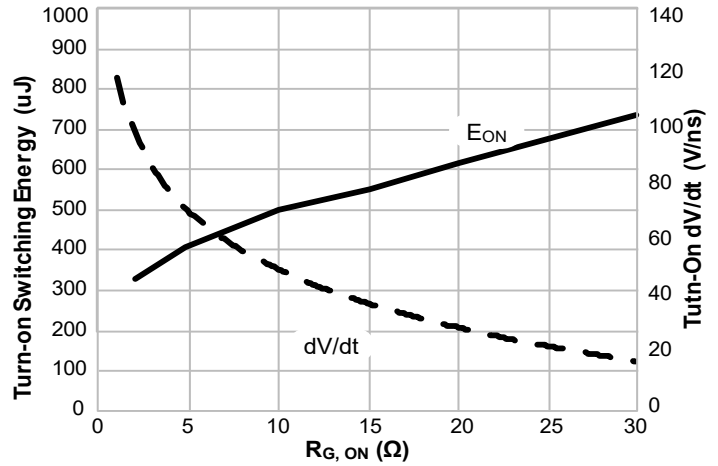

Figure 14. Power De-rating (Note I)

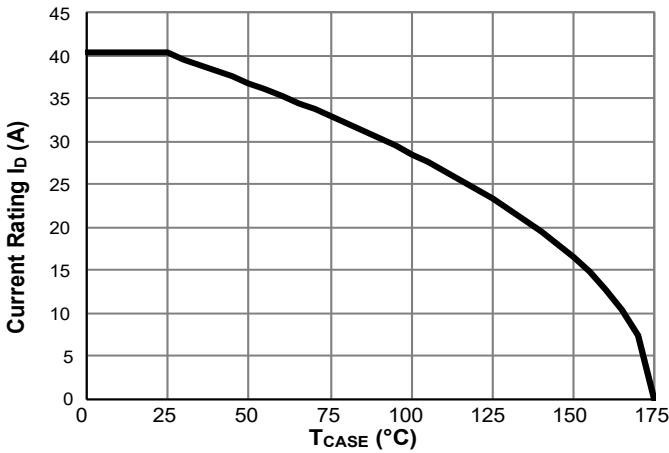

Figure 15. Current De-rating (Note I)

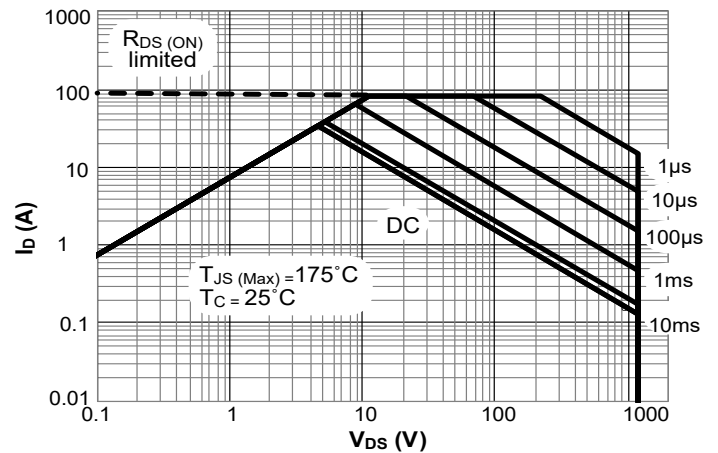

Figure 16. Maximum Forward Biased Safe Operating Area for AOK065V65X2 (Note I)

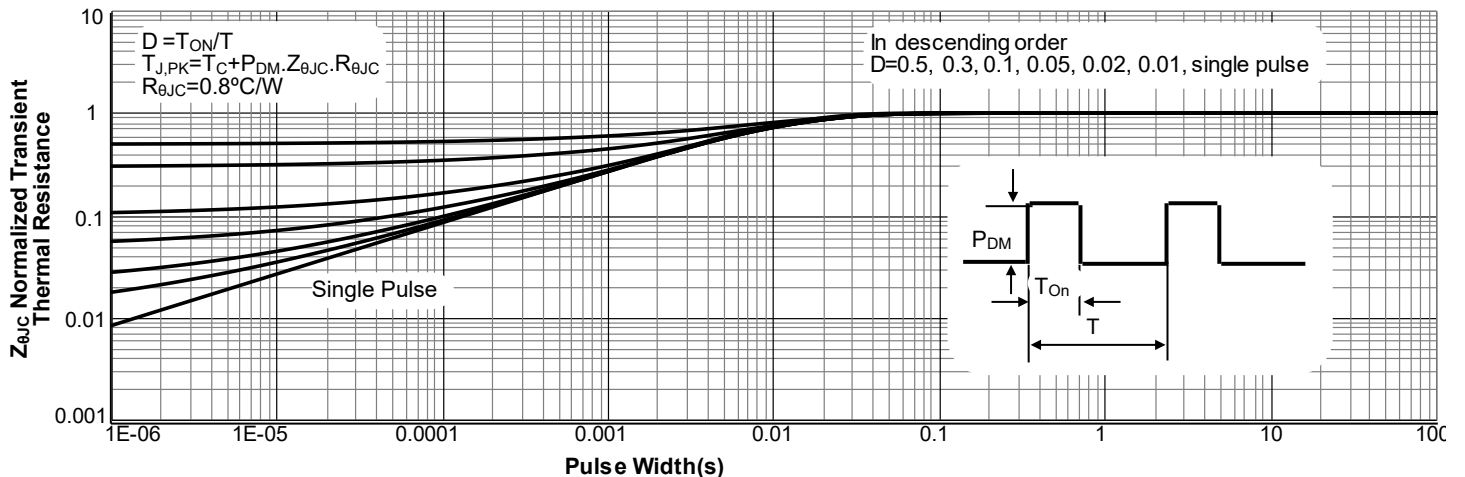

Figure 17. Normalized Maximum Transient Thermal Impedance for AOK065V65X2 (Note I)

Test Circuits and Waveforms

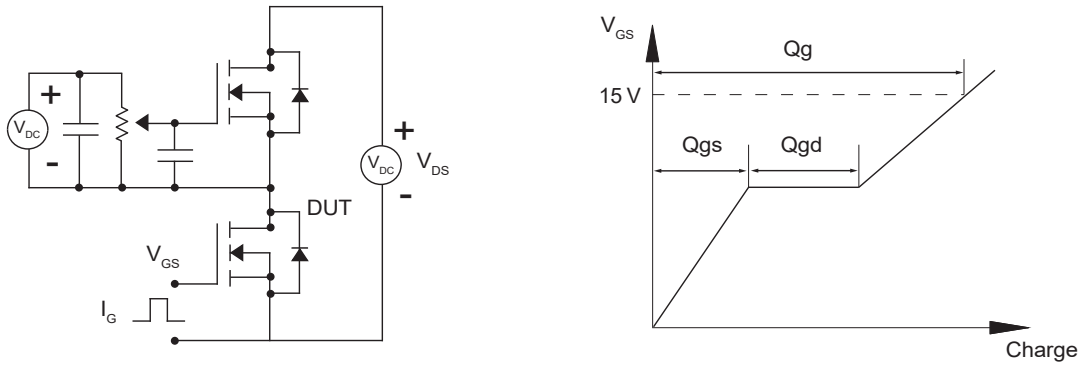

Figure 18. Gate Charge Test Circuits and Waveforms

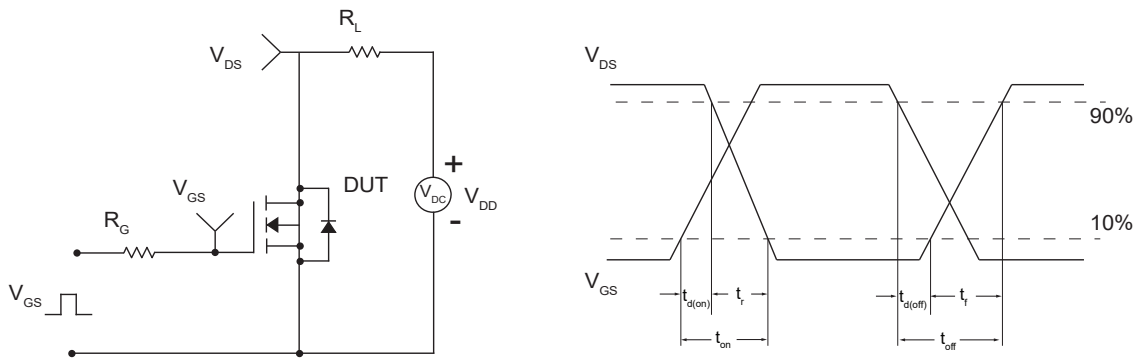

Figure 19. Resistive Switching Test Circuit and Waveforms

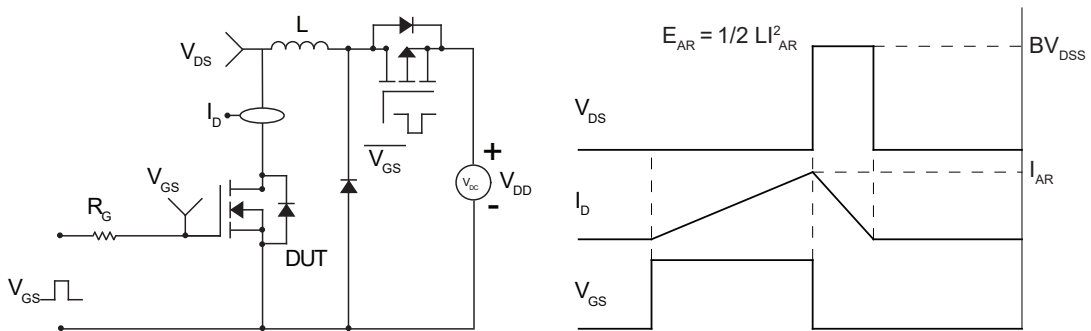

Figure 20. Unclamped Inductive Switching (UIS) Test Circuit and Waveforms

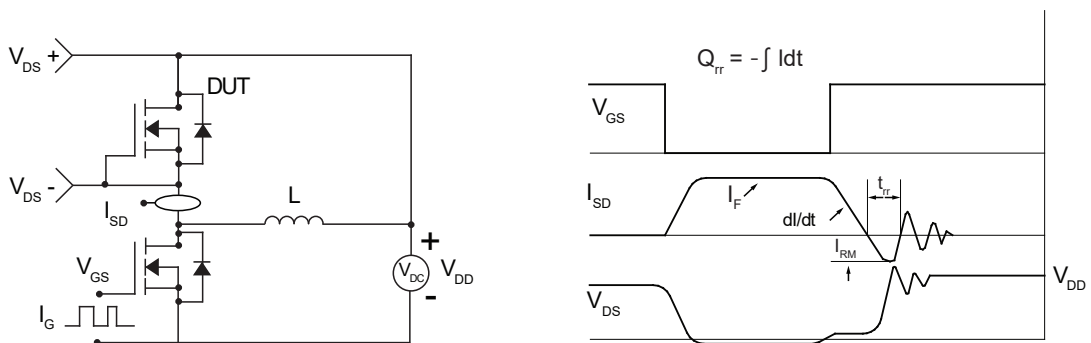
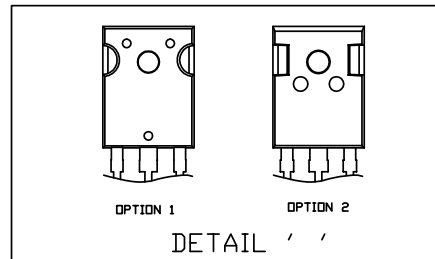
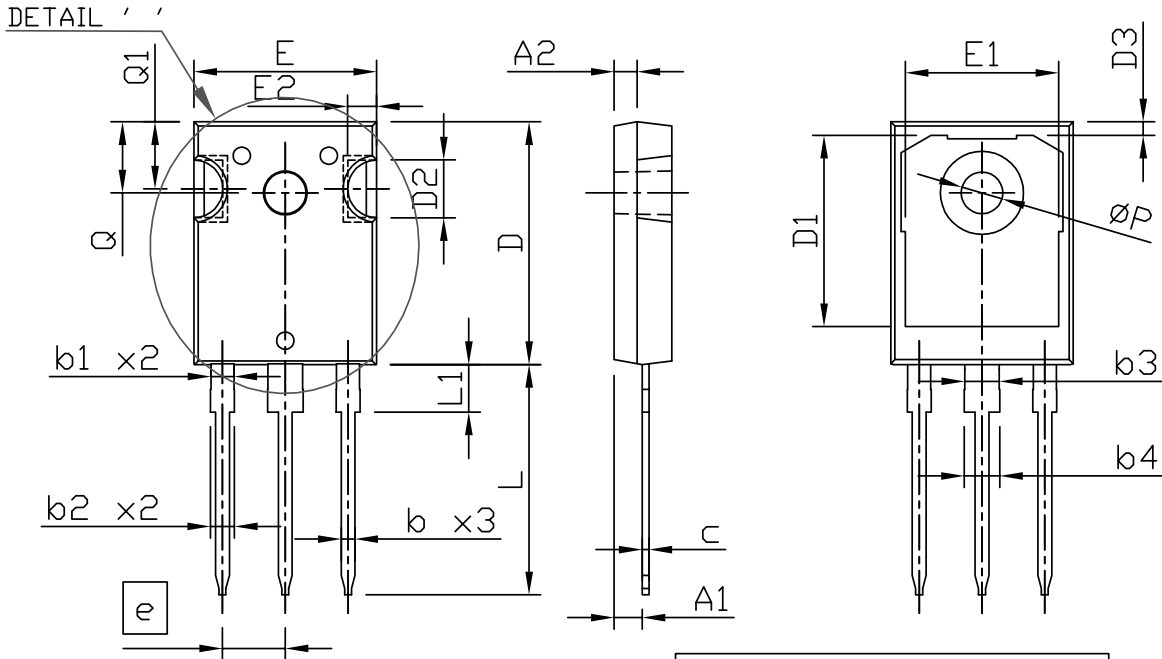
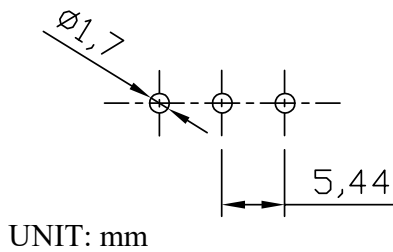

Figure 21. Diode Recovery Test Circuits and Waveforms

Package Dimensions, TO247-3L



RECOMMENDED LAND PATTERN



SYMBOLS	DIMENSIONS IN MILLIMETERS			DIMENSIONS IN INCHES		
	MIN	NOM	MAX	MIN	NOM	MAX
A	4.90	5.00	5.10	0.193	0.197	0.201
A1	2.31	2.42	2.52	0.091	0.095	0.099
A2	1.90	2.00	2.10	0.075	0.079	0.083
b	1.16	1.22	1.27	0.046	0.048	0.050
b1	1.96	2.02	2.07	0.078	0.080	0.081
b2	2.00	2.10	2.20	0.079	0.083	0.087
b3	2.96	3.02	3.07	0.117	0.119	0.121
b4	3.00	3.10	3.20	0.118	0.122	0.126
c	0.59	0.62	0.66	0.023	0.024	0.026
D	20.90	21.00	21.10	0.823	0.827	0.831
D1	16.25	16.55	16.85	0.640	0.652	0.663
D2	5.00 TYP			0.197 TYP		
D3	1.05	1.20	1.35	0.041	0.047	0.053
e	5.44 BSC			0.214 BSC		
E	15.70	15.80	15.90	0.618	0.622	0.626
E1	13.06	13.26	13.50	0.514	0.522	0.530
E2	2.50 TYP			0.098 TYP		
L	19.72	19.92	20.12	0.776	0.784	0.792
L1	---	---	4.30	---	---	0.169
Q	6.15 BSC			0.242 BSC		
Q1	5.60	5.80	6.00	0.220	0.228	0.236
ØP	3.55	3.60	3.70	0.140	0.142	0.146

NOTE

1. PACKAGE BODY SIZES EXCLUDE MOLD FLASH AND GATE BURRS.
MOLD FLASH AT THE NON-LEAD SIDES SHOULD BE LESS THAN 6 MILS EACH.
2. CONTROLLING DIMENSION IS MILLIMETER.
CONVERTED INCH DIMENSIONS ARE NOT NECESSARILY EXACT.

Part Marking

TO-247-3L

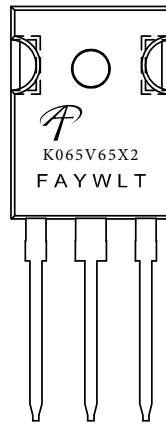

LEGAL DISCLAIMER

Applications or uses as critical components in life support devices or systems are not authorized. Alpha and Omega Semiconductor does not assume any liability arising out of such applications or uses of its products. AOS reserves the right to make changes to product specifications without notice. It is the responsibility of the customer to evaluate suitability of the product for their intended application. Customer shall comply with applicable legal requirements, including all applicable export control rules, regulations and limitations.

AOS's products are provided subject to AOS's terms and conditions of sale which are set forth at:
http://www.aosmd.com/terms_and_conditions_of_sale

LIFE SUPPORT POLICY

ALPHA AND OMEGA SEMICONDUCTOR PRODUCTS ARE NOT AUTHORIZED FOR USE AS CRITICAL COMPONENTS IN LIFE SUPPORT DEVICES OR SYSTEMS.

As used herein:

1. Life support devices or systems are devices or systems which, (a) are intended for surgical implant into the body or (b) support or sustain life, and (c) whose failure to perform when properly used in accordance with instructions for use provided in the labeling, can be reasonably expected to result in a significant injury of the user.
2. A critical component in any component of a life support, device, or system whose failure to perform can be reasonably expected to cause the failure of the life support device or system, or to affect its safety or effectiveness.