

General Description

- Latest Trench Power MOSFET technology
- Very Low $R_{DS(ON)}$ at 1.8V V_{GS}
- Low Gate Charge
- ESD protection
- RoHS and Halogen-Free Compliant

Application

- Battery path load switch
- System load switch

Product Summary

V_{DS}	-12V
I_D (at $V_{GS}=-4.5V$)	-20A
$R_{DS(ON)}$ (at $V_{GS}=-4.5V$)	< 8m Ω
$R_{DS(ON)}$ (at $V_{GS}=-3.0V$)	< 10.2m Ω
$R_{DS(ON)}$ (at $V_{GS}=-2.5V$)	< 11.6m Ω
$R_{DS(ON)}$ (at $V_{GS}=-1.8V$)	< 17.5m Ω

Typical ESD protection

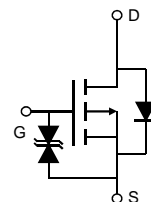
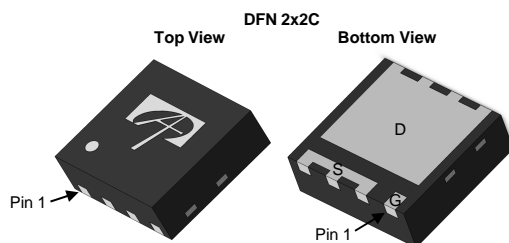
HBM Class 2

Orderable Part Number	Package Type	Form	Minimum Order Quantity
AON2411	DFN 2x2C	Tape & Reel	3000

Absolute Maximum Ratings $T_A=25^\circ\text{C}$ unless otherwise noted

Parameter	Symbol	Maximum	Units
Drain-Source Voltage	V_{DS}	-12	V
Gate-Source Voltage	V_{GS}	± 8	V
Continuous Drain Current ^G	I_D	-20	A
		$T_A=70^\circ\text{C}$	
Pulsed Drain Current ^C	I_{DM}	-80	
Power Dissipation ^B	P_D	$T_A=25^\circ\text{C}$	5.0
		$T_A=70^\circ\text{C}$	3.2
Junction and Storage Temperature Range	T_J, T_{STG}	-55 to 150	$^\circ\text{C}$

Thermal Characteristics

Parameter	Symbol	Typ	Max	Units
Maximum Junction-to-Ambient ^A $t \leq 10s$	$R_{\theta JA}$	20	25	$^\circ\text{C/W}$
Maximum Junction-to-Ambient ^{A, D} Steady-State		45	55	$^\circ\text{C/W}$

Electrical Characteristics (T_J=25°C unless otherwise noted)

Symbol	Parameter	Conditions	Min	Typ	Max	Units
STATIC PARAMETERS						
BV _{DSS}	Drain-Source Breakdown Voltage	I _D =-250μA, V _{GS} =0V	-12			V
I _{DSS}	Zero Gate Voltage Drain Current	V _{DS} =-12V, V _{GS} =0V T _J =55°C			-1 -5	μA
I _{GSS}	Gate-Body leakage current	V _{DS} =0V, V _{GS} =±8V			±10	μA
V _{GS(th)}	Gate Threshold Voltage	V _{DS} =V _{GS} , I _D =-250μA	-0.3	-0.6	-0.9	V
R _{DS(on)}	Static Drain-Source On-Resistance	V _{GS} =-4.5V, I _D =-12A T _J =125°C		6.6	8.0	mΩ
				8.6	10.4	
		V _{GS} =-3.0V, I _D =-11A		8.1	10.2	mΩ
		V _{GS} =-2.5V, I _D =-10A		9.2	11.6	mΩ
		V _{GS} =-1.8V, I _D =-8A		13.7	17.5	mΩ
g _{FS}	Forward Transconductance	V _{DS} =-5V, I _D =-12A		60		S
V _{SD}	Diode Forward Voltage	I _S =1A, V _{GS} =0V		-0.59	-1	V
I _S	Maximum Body-Diode Continuous Current				-7	A
DYNAMIC PARAMETERS						
C _{iss}	Input Capacitance	V _{GS} =0V, V _{DS} =-6V, f=1MHz		2180		pF
C _{oss}	Output Capacitance			675		pF
C _{riss}	Reverse Transfer Capacitance			425		pF
R _g	Gate resistance	f=1MHz		13.5		Ω
SWITCHING PARAMETERS						
Q _g	Total Gate Charge	V _{GS} =-4.5V, V _{DS} =-6V, I _D =-12A		20	30	nC
Q _{gs}	Gate Source Charge			4		nC
Q _{gd}	Gate Drain Charge			5.5		nC
t _{D(on)}	Turn-On DelayTime	V _{GS} =-4.5V, V _{DS} =-6V, R _L =0.5Ω, R _{GEN} =3Ω		15		ns
t _r	Turn-On Rise Time			45		ns
t _{D(off)}	Turn-Off DelayTime			135		ns
t _f	Turn-Off Fall Time			185		ns
t _{rr}	Body Diode Reverse Recovery Time	I _F =-12A, di/dt=100A/μs		28		ns
Q _{rr}	Body Diode Reverse Recovery Charge	I _F =-12A, di/dt=100A/μs		13		nC

A. The value of R_{θJA} is measured with the device mounted on 1in² FR-4 board with 2oz. Copper, in a still air environment with T_A =25° C. The value in any given application depends on the user's specific board design.

B. The power dissipation P_D is based on T_{J(MAX)}=150° C, using ≤ 10s junction-to-ambient thermal resistance.

C. Repetitive rating, pulse width limited by junction temperature T_{J(MAX)}=150° C. Ratings are based on low frequency and duty cycles to keep initial T_J=25° C.

D. The R_{θJA} is the sum of the thermal impedance from junction to lead R_{θJL} and lead to ambient.

E. The static characteristics in Figures 1 to 6 are obtained using <300μs pulses, duty cycle 0.5% max.

F. These curves are based on the junction-to-ambient thermal impedance which is measured with the device mounted on 1in² FR-4 board with 2oz. Copper, assuming a maximum junction temperature of T_{J(MAX)}=150° C. The SOA curve provides a single pulse rating.

THIS PRODUCT HAS BEEN DESIGNED AND QUALIFIED FOR THE CONSUMER MARKET. APPLICATIONS OR USES AS CRITICAL COMPONENTS IN LIFE SUPPORT DEVICES OR SYSTEMS ARE NOT AUTHORIZED. AOS DOES NOT ASSUME ANY LIABILITY ARISING OUT OF SUCH APPLICATIONS OR USES OF ITS PRODUCTS. AOS RESERVES THE RIGHT TO IMPROVE PRODUCT DESIGN, FUNCTIONS AND RELIABILITY WITHOUT NOTICE.

TYPICAL ELECTRICAL AND THERMAL CHARACTERISTICS

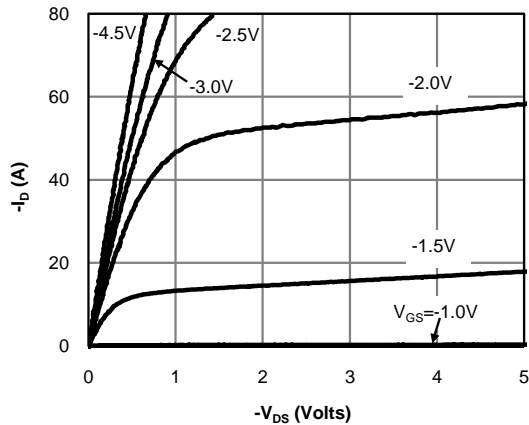

Figure 1: On-Region Characteristics (Note E)

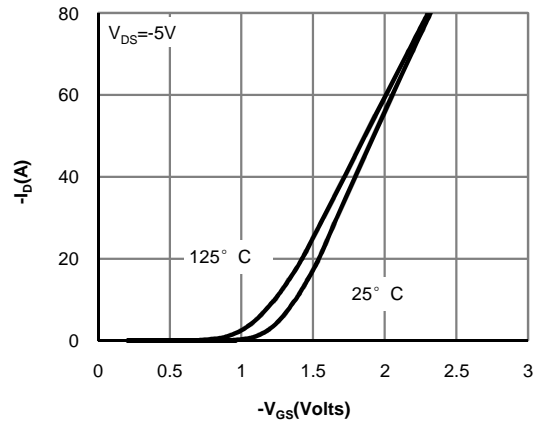

Figure 2: Transfer Characteristics (Note E)

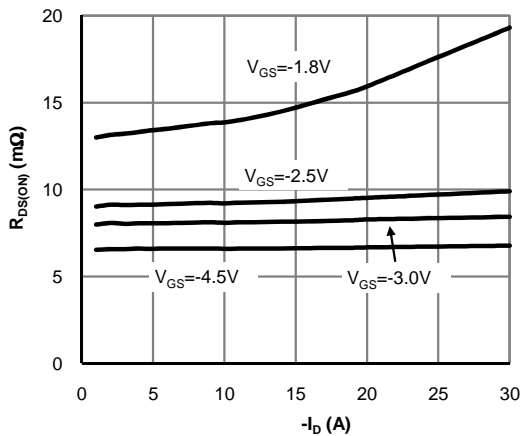

Figure 3: On-Resistance vs. Drain Current and Gate Voltage (Note E)

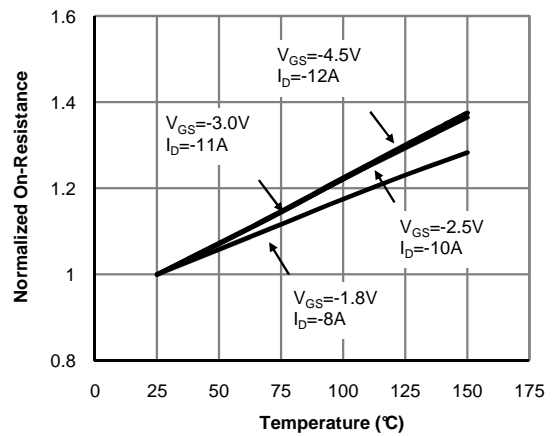

Figure 4: On-Resistance vs. Junction Temperature (Note E)

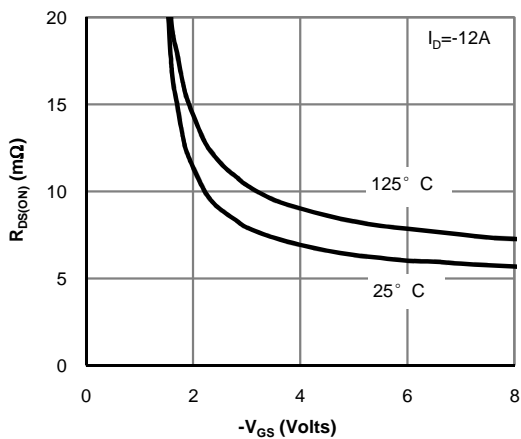

Figure 5: On-Resistance vs. Gate-Source Voltage (Note E)

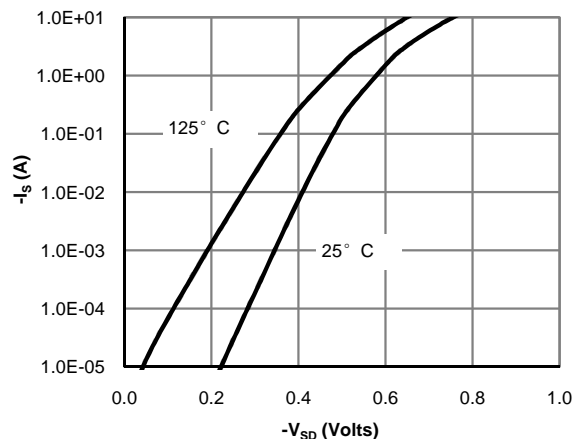

Figure 6: Body-Diode Characteristics (Note E)

TYPICAL ELECTRICAL AND THERMAL CHARACTERISTICS

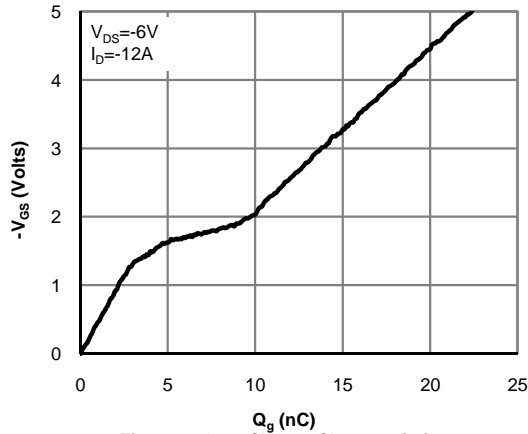

Figure 7: Gate-Charge Characteristics

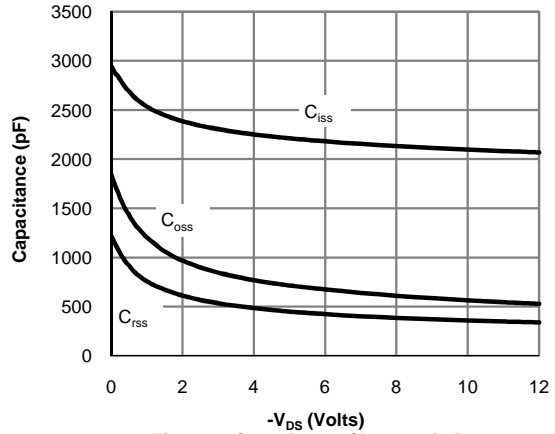

Figure 8: Capacitance Characteristics

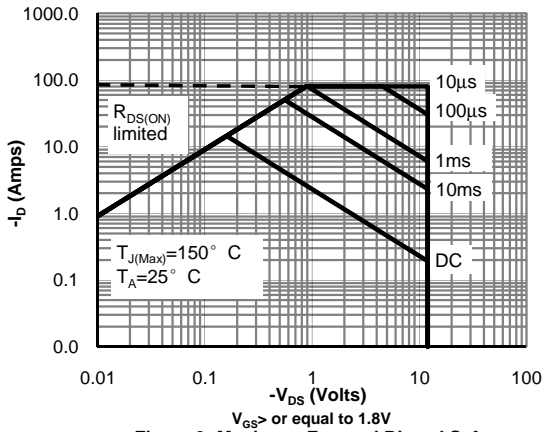

Figure 9: Maximum Forward Biased Safe Operating Area (Note F)

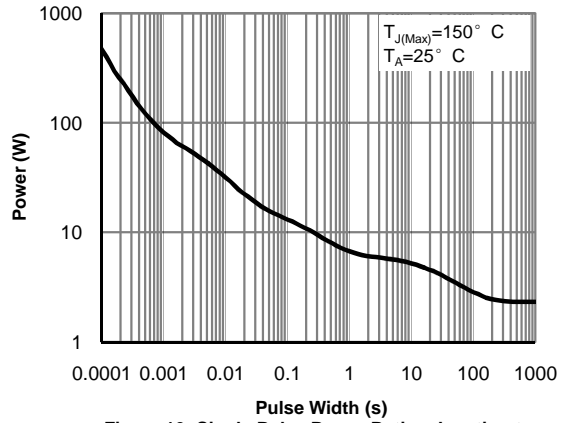

Figure 10: Single Pulse Power Rating Junction-to-Ambient (Note F)

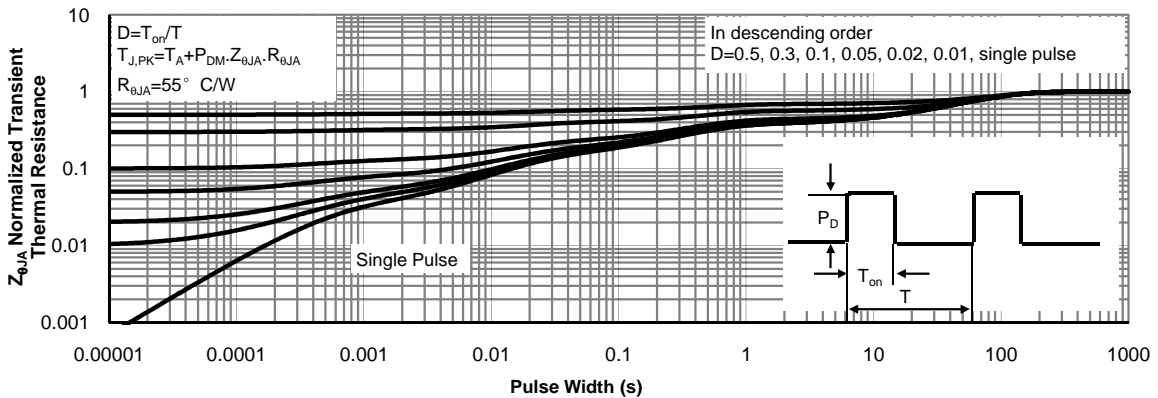
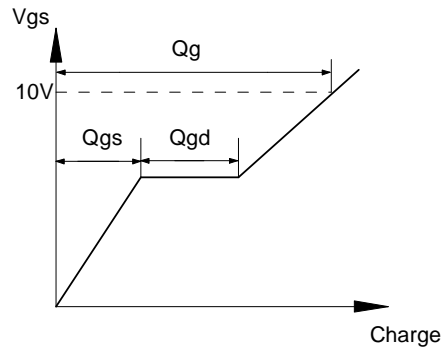
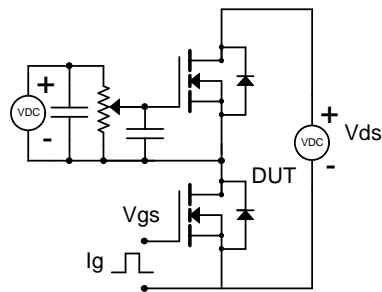
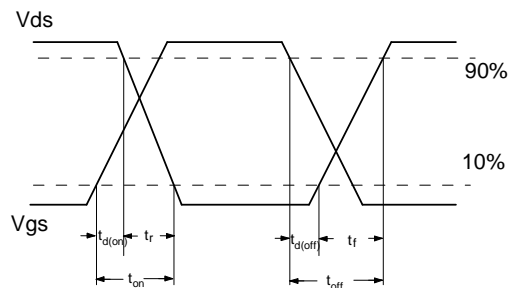
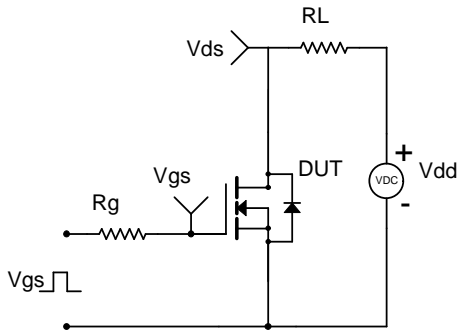

Figure 11: Normalized Maximum Transient Thermal Impedance (Note F)

Gate Charge Test Circuit & Waveform



Resistive Switching Test Circuit & Waveforms



Unclamped Inductive Switching (UIS) Test Circuit & Waveforms

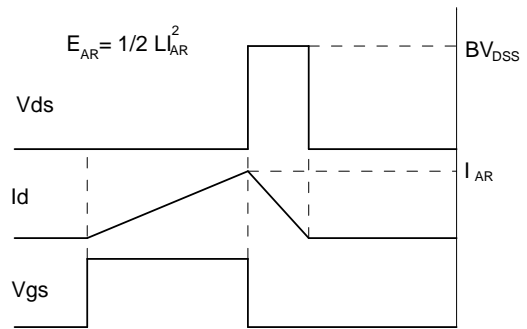
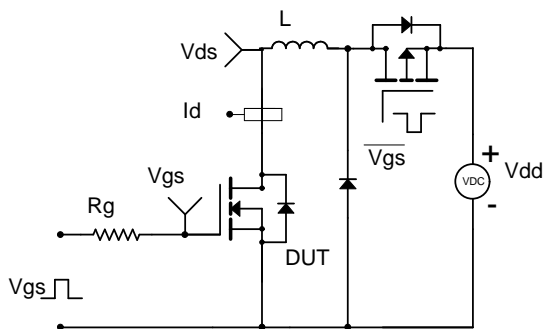

Diode Recovery Test Circuit & Waveforms

