



**General Description**

- Latest advanced trench technology
- Low  $R_{DS(ON)}$
- High Current Capability
- RoHS and Halogen-Free Compliant

**Applications**

- Notebook AC-in load switch
- Battery protection charge/discharge

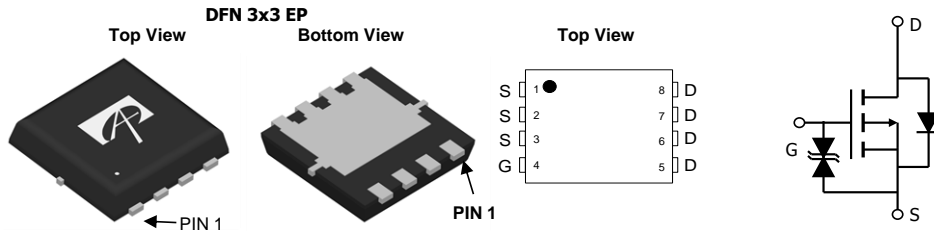
**Product Summary**

$V_{DS}$	-30V
$I_D$ (at $V_{GS}=-10V$ )	-12A
$R_{DS(ON)}$ (at $V_{GS}=-10V$ )	< 40m $\Omega$
$R_{DS(ON)}$ (at $V_{GS}=-4.5V$ )	< 61m $\Omega$

**Typical ESD protection**

100% UIS Tested  
100% Rg Tested

**HBM Class 1C**



Orderable Part Number	Package Type	Form	Minimum Order Quantity
AONR21311C	DFN 3x3 EP	Tape & Reel	5000

**Absolute Maximum Ratings**  $T_A=25^\circ\text{C}$  unless otherwise noted

Parameter	Symbol	Maximum	Units
Drain-Source Voltage	$V_{DS}$	-30	V
Gate-Source Voltage	$V_{GS}$	$\pm 20$	V
Continuous Drain Current <sup>G</sup>	$I_D$	$T_C=25^\circ\text{C}$	-12
		$T_C=100^\circ\text{C}$	-8.3
Pulsed Drain Current <sup>C</sup>	$I_{DM}$	-48	A
Continuous Drain Current <sup>G</sup>	$I_{DSM}$	$T_A=25^\circ\text{C}$	-7
		$T_A=70^\circ\text{C}$	-5.5
Avalanche Current <sup>C</sup>	$I_{AS}$	13	A
Avalanche energy	$E_{AS}$	8	mJ
Power Dissipation <sup>B</sup>	$P_D$	$T_C=25^\circ\text{C}$	11
		$T_C=100^\circ\text{C}$	4.5
Power Dissipation <sup>A</sup>	$P_{DSM}$	$T_A=25^\circ\text{C}$	3.1
		$T_A=70^\circ\text{C}$	2
Junction and Storage Temperature Range	$T_J, T_{STG}$	-55 to 150	$^\circ\text{C}$

**Thermal Characteristics**

Parameter	Symbol	Typ	Max	Units
Maximum Junction-to-Ambient <sup>A</sup>	$R_{\theta JA}$	25	40	$^\circ\text{C/W}$
Maximum Junction-to-Ambient <sup>A, D</sup>		Steady-State	62	75
Maximum Junction-to-Case	$R_{\theta JC}$	8.8	11	$^\circ\text{C/W}$

**Electrical Characteristics (T<sub>J</sub>=25°C unless otherwise noted)**

Symbol	Parameter	Conditions	Min	Typ	Max	Units
<b>STATIC PARAMETERS</b>						
BV <sub>DSS</sub>	Drain-Source Breakdown Voltage	I <sub>D</sub> =-250μA, V <sub>GS</sub> =0V	-30			V
I <sub>DSS</sub>	Zero Gate Voltage Drain Current	V <sub>DS</sub> =-30V, V <sub>GS</sub> =0V T <sub>J</sub> =55°C			-1 -5	μA
I <sub>GSS</sub>	Gate-Body leakage current	V <sub>DS</sub> =0V, V <sub>GS</sub> =±20V			±10	μA
V <sub>GS(th)</sub>	Gate Threshold Voltage	V <sub>DS</sub> =V <sub>GS</sub> , I <sub>D</sub> =-250μA	-1.2	-1.7	-2.2	V
R <sub>DS(ON)</sub>	Static Drain-Source On-Resistance	V <sub>GS</sub> =-10V, I <sub>D</sub> =-7A T <sub>J</sub> =125°C		33 50	40 60	mΩ
		V <sub>GS</sub> =-4.5V, I <sub>D</sub> =-5.7A		48	61	mΩ
g <sub>FS</sub>	Forward Transconductance	V <sub>DS</sub> =-5V, I <sub>D</sub> =-7A		20		S
V <sub>SD</sub>	Diode Forward Voltage	I <sub>S</sub> =-1A, V <sub>GS</sub> =0V		-0.8	-1	V
I <sub>S</sub>	Maximum Body-Diode Continuous Current <sup>6</sup>				-12	A
<b>DYNAMIC PARAMETERS</b>						
C <sub>iss</sub>	Input Capacitance	V <sub>GS</sub> =0V, V <sub>DS</sub> =-15V, f=1MHz		720		pF
C <sub>oss</sub>	Output Capacitance			80		pF
C <sub>riss</sub>	Reverse Transfer Capacitance			70		pF
R <sub>g</sub>	Gate resistance	f=1MHz		15	25	Ω
<b>SWITCHING PARAMETERS</b>						
Q <sub>g(10V)</sub>	Total Gate Charge	V <sub>GS</sub> =-10V, V <sub>DS</sub> =-15V, I <sub>D</sub> =-7A		12.5	23	nC
Q <sub>g(4.5V)</sub>	Total Gate Charge			6	12	nC
Q <sub>gs</sub>	Gate Source Charge			1.6		nC
Q <sub>gd</sub>	Gate Drain Charge			3		nC
t <sub>D(on)</sub>	Turn-On DelayTime	V <sub>GS</sub> =-10V, V <sub>DS</sub> =-15V, R <sub>L</sub> =2.14Ω, R <sub>GEN</sub> =3Ω		8.5		ns
t <sub>r</sub>	Turn-On Rise Time			5		ns
t <sub>D(off)</sub>	Turn-Off DelayTime			39		ns
t <sub>f</sub>	Turn-Off Fall Time			14.5		ns
t <sub>rr</sub>	Body Diode Reverse Recovery Time	I <sub>F</sub> =-7A, di/dt=500A/μs		10		ns
Q <sub>rr</sub>	Body Diode Reverse Recovery Charge	I <sub>F</sub> =-7A, di/dt=500A/μs		13		nC

A. The value of R<sub>θJA</sub> is measured with the device mounted on 1in<sup>2</sup> FR-4 board with 2oz. Copper, in a still air environment with T<sub>A</sub>=25° C. The Power dissipation P<sub>DSSM</sub> is based on R<sub>θJA</sub> ≤ 10s and the maximum allowed junction temperature of 150° C. The value in any given application depends on the user's specific board design.

B. The power dissipation P<sub>D</sub> is based on T<sub>J(MAX)</sub>=150° C, using junction-to-case thermal resistance, and is more useful in setting the upper dissipation limit for cases where additional heatsinking is used.

C. Single pulse width limited by junction temperature T<sub>J(MAX)</sub>=150° C.

D. The R<sub>θJA</sub> is the sum of the thermal impedance from junction to case R<sub>θJC</sub> and case to ambient.

E. The static characteristics in Figures 1 to 6 are obtained using <300μs pulses, duty cycle 0.5% max.

F. These curves are based on the junction-to-case thermal impedance which is measured with the device mounted to a large heatsink, assuming a maximum junction temperature of T<sub>J(MAX)</sub>=150° C. The SOA curve provides a single pulse rating.

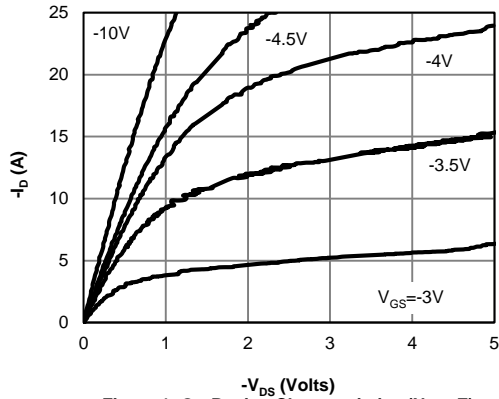
G. The maximum current rating is package limited.

H. These tests are performed with the device mounted on 1 in<sup>2</sup> FR-4 board with 2oz. Copper, in a still air environment with T<sub>A</sub>=25° C.

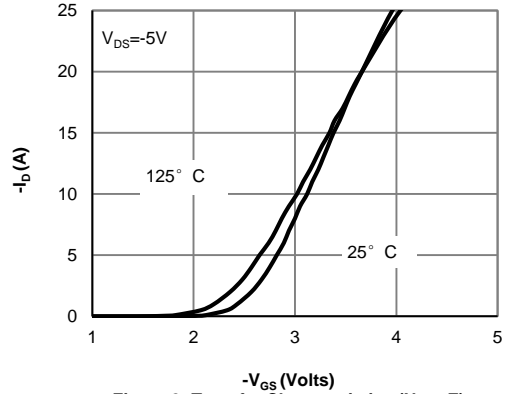
APPLICATIONS OR USES AS CRITICAL COMPONENTS IN LIFE SUPPORT DEVICES OR SYSTEMS ARE NOT AUTHORIZED. AOS DOES NOT ASSUME ANY LIABILITY ARISING OUT OF SUCH APPLICATIONS OR USES OF ITS PRODUCTS. AOS RESERVES THE RIGHT TO MAKE CHANGES TO PRODUCT SPECIFICATIONS WITHOUT NOTICE. IT IS THE RESPONSIBILITY OF THE CUSTOMER TO EVALUATE SUITABILITY OF THE PRODUCT FOR THEIR INTENDED APPLICATION. CUSTOMER SHALL COMPLY WITH APPLICABLE LEGAL REQUIREMENTS, INCLUDING ALL APPLICABLE EXPORT CONTROL RULES, REGULATIONS AND LIMITATIONS.

AOS' products are provided subject to AOS' terms and conditions of sale which are set forth at:  
[http://www.aosmd.com/terms\\_and\\_conditions\\_of\\_sale](http://www.aosmd.com/terms_and_conditions_of_sale)

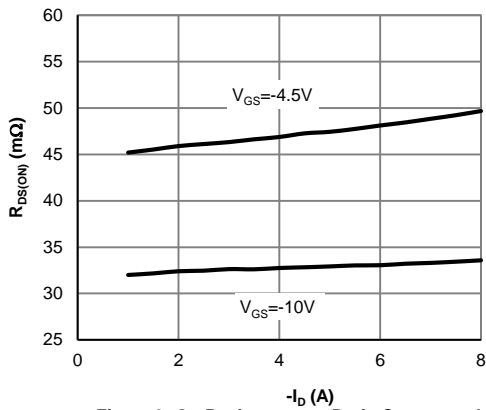
**TYPICAL ELECTRICAL AND THERMAL CHARACTERISTICS**



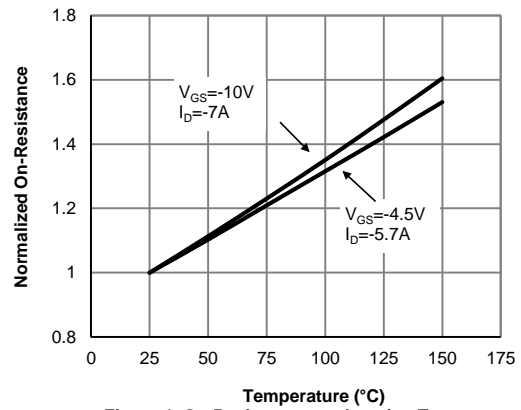
**Figure 1: On-Region Characteristics (Note E)**



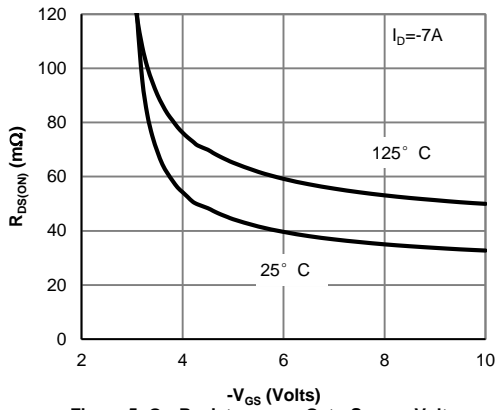
**Figure 2: Transfer Characteristics (Note E)**



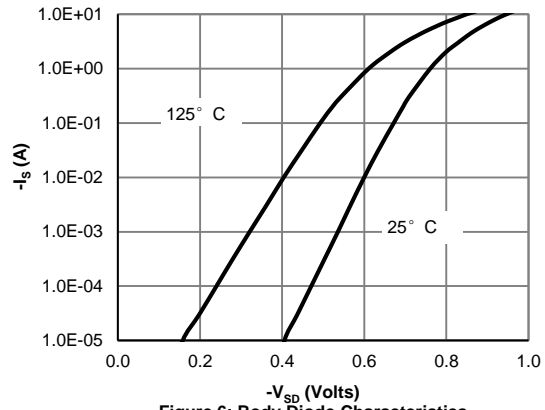
**Figure 3: On-Resistance vs. Drain Current and Gate Voltage (Note E)**



**Figure 4: On-Resistance vs. Junction Temperature (Note E)**

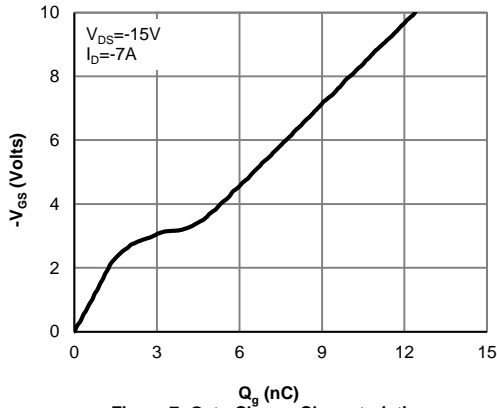


**Figure 5: On-Resistance vs. Gate-Source Voltage (Note E)**

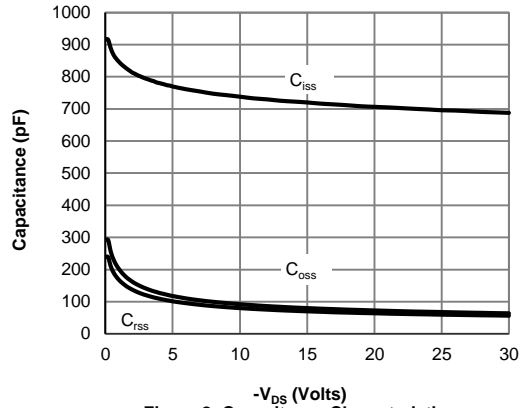


**Figure 6: Body-Diode Characteristics (Note E)**

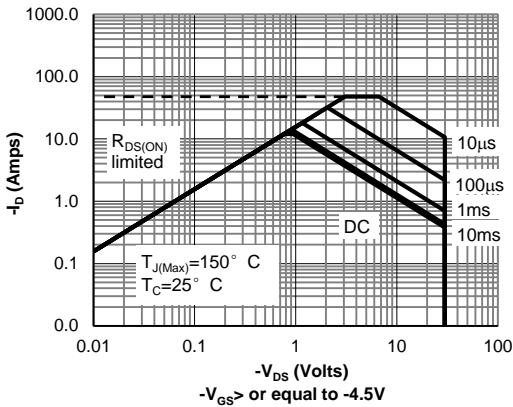
**TYPICAL ELECTRICAL AND THERMAL CHARACTERISTICS**



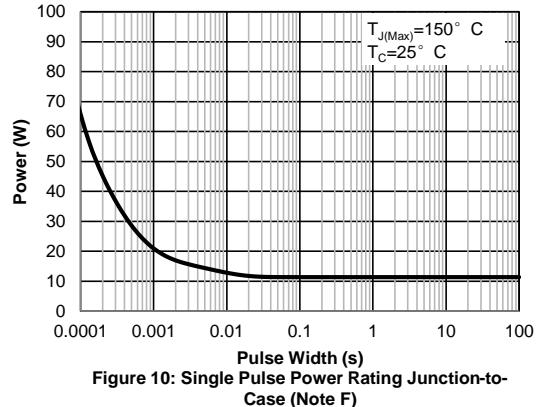
**Figure 7: Gate-Charge Characteristics**



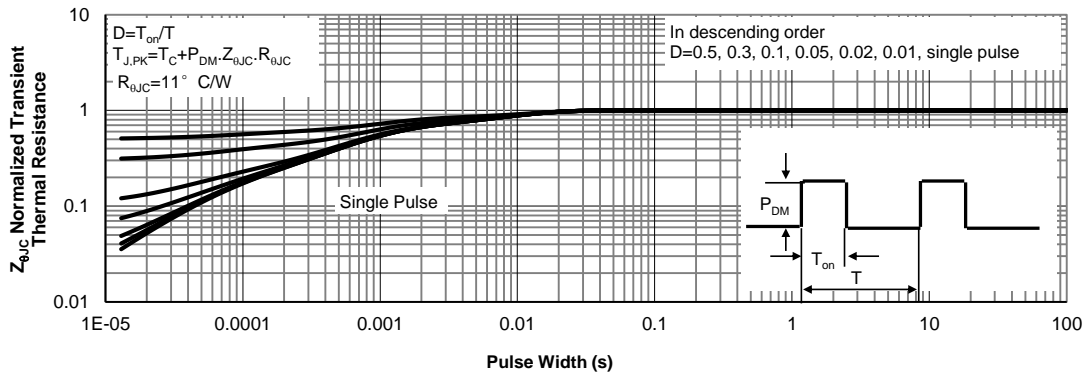
**Figure 8: Capacitance Characteristics**



**Figure 9: Maximum Forward Biased Safe Operating Area (Note F)**



**Figure 10: Single Pulse Power Rating Junction-to-Case (Note F)**



**Figure 11: Normalized Maximum Transient Thermal Impedance (Note F)**

**TYPICAL ELECTRICAL AND THERMAL CHARACTERISTICS**

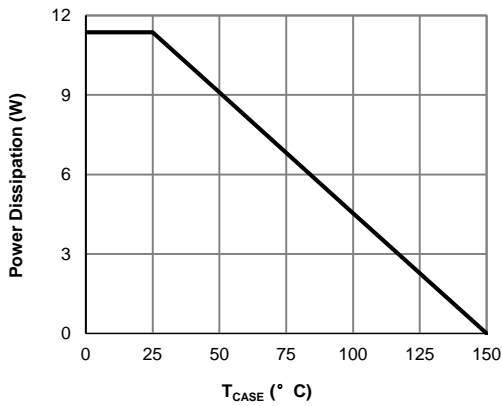


Figure 12: Power De-rating (Note F)

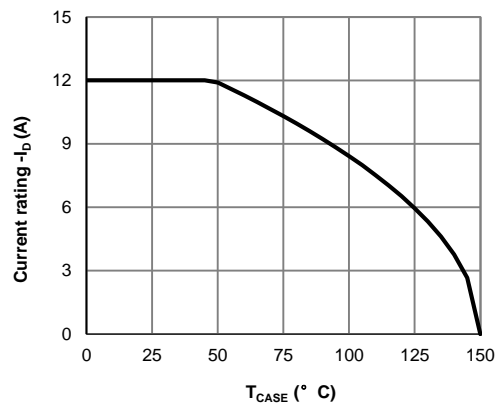


Figure 13: Current De-rating (Note F)

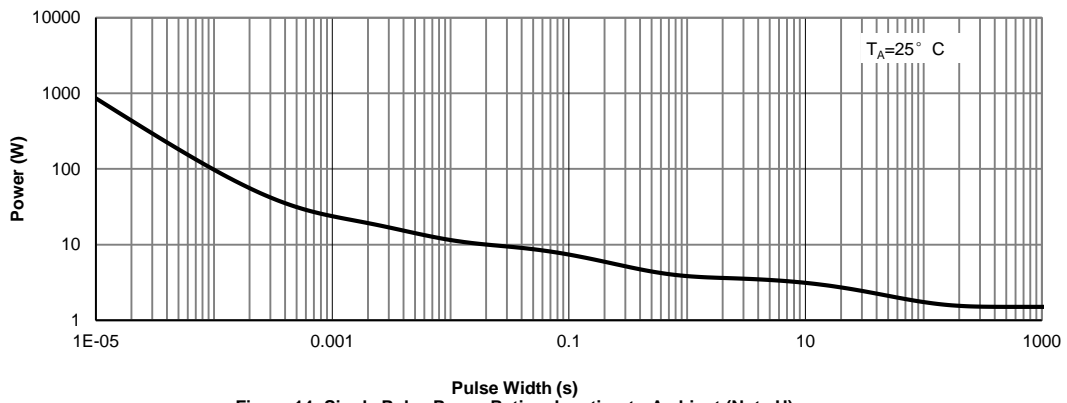


Figure 14: Single Pulse Power Rating Junction-to-Ambient (Note H)

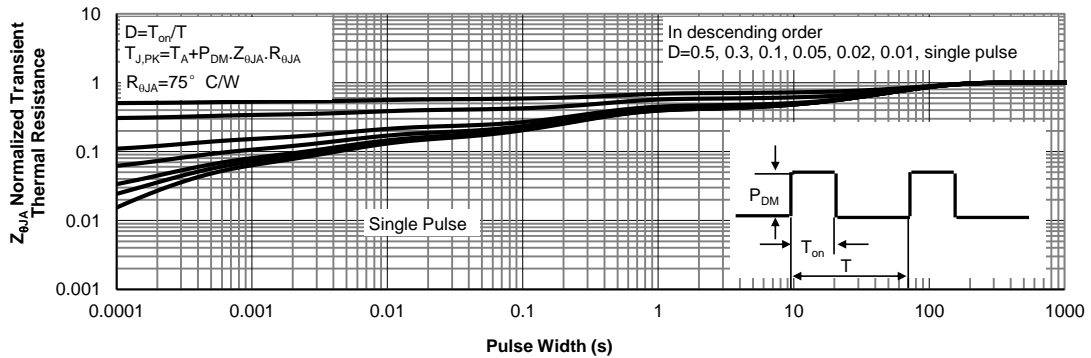
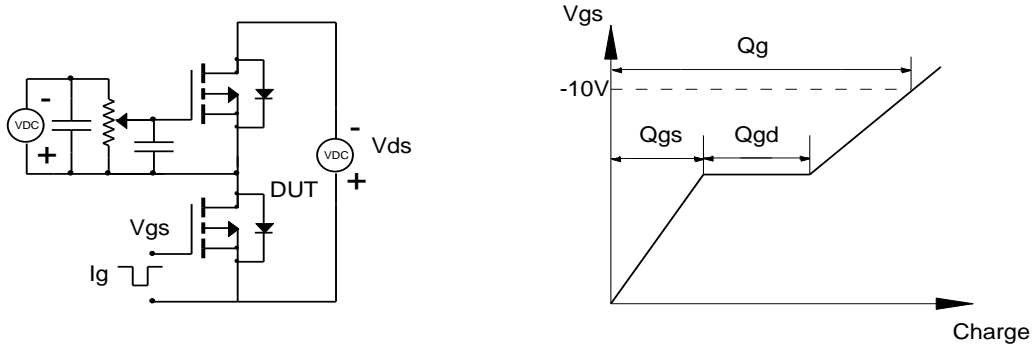
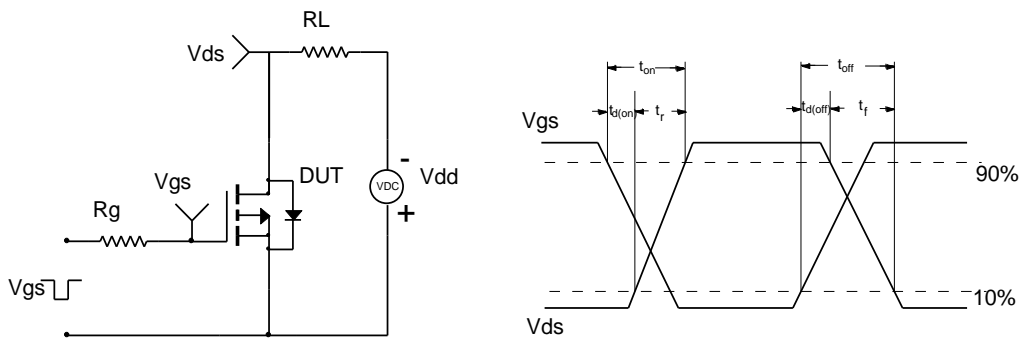


Figure 15: Normalized Maximum Transient Thermal Impedance (Note H)

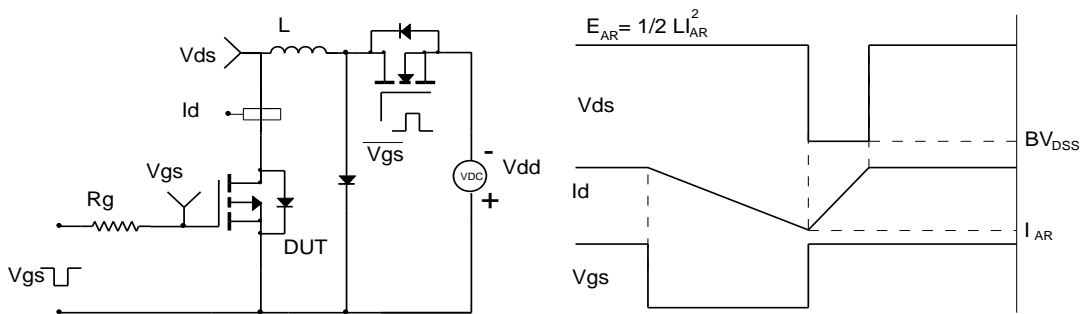
**Gate Charge Test Circuit & Waveform**



**Resistive Switching Test Circuit & Waveforms**



**Unclamped Inductive Switching (UIS) Test Circuit & Waveforms**



**Diode Recovery Test Circuit & Waveforms**

