

## General Description

The AOZ1010 is a high efficiency, simple to use, 2A buck regulator. The AOZ1010 works from a 4.5V to 16V input voltage range, and provides up to 2A of continuous output current with an output voltage adjustable down to 0.8V.

The AOZ1010 comes in an SO-8 package and is rated over a -40°C to +85°C ambient temperature range.

## Features

- 4.5V to 16V operating input voltage range
- 130 mΩ internal PFET switch for high efficiency: up to 95%
- Internal Schottky Diode
- Internal soft start
- Output voltage adjustable to 0.8V
- 2A continuous output current
- Fixed 500kHz PWM operation
- Cycle-by-cycle current limit
- Short-circuit protection
- Thermal shutdown
- Small size SO-8 package

## Applications

- Point of load dc/dc conversion
- PCIe graphics cards
- Set top boxes
- DVD drives and HDD
- LCD panels
- Cable modems
- Telecom/Networking/Datacom equipment

## Typical Application

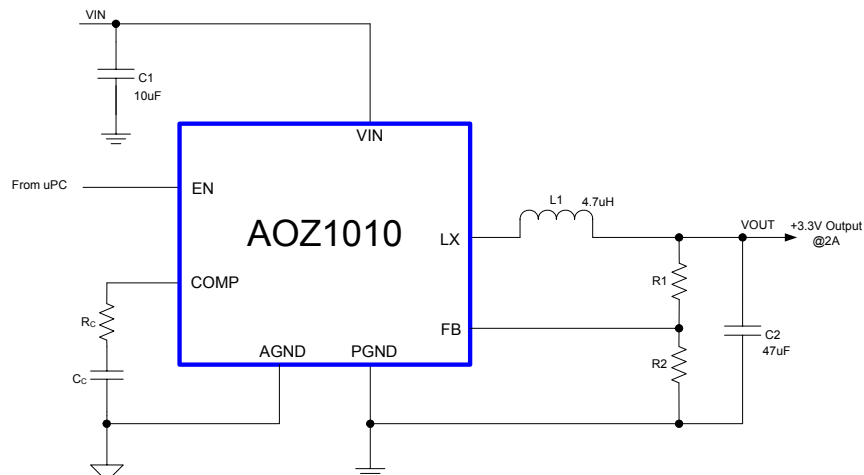

Figure 1. 3.3V/2A Buck Down Regulator



### Ordering Information

Part Number	Ambient Temperature Range	Package	Environmental
AOZ1010AI	-40°C to +85°C	SO-8	RoHS

### Pin Configuration

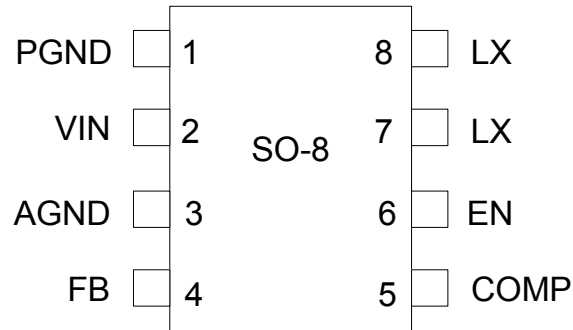

### Pin Description

Pin Number	Pin Name	Pin Function
1	PGND	Power ground. Electrically needs to be connected to AGND.
2	VIN	Supply voltage input. When VIN rises above the UVLO threshold the device starts up.
3	AGND	Reference connection for controller section. Also used as thermal connection for controller section. Electrically needs to be connected to PGND.
4	FB	The FB pin is used to determine the output voltage via a resistor divider between the output and GND.
5	COMP	External loop compensation pin.
6	EN	The enable pin is active high. Connect EN pin to VIN if not used. Do not leave the EN pin floating.
7,8	LX	PWM output connection to inductor. Thermal connection for output stage.

### Absolute Maximum Ratings<sup>(1)</sup>

Parameter	Units
Supply Voltage ( $V_{IN}$ )	18V
LX to AGND	-0.7V to $V_{IN}+0.3V$
EN to AGND	-0.3V to $V_{IN}+0.3V$
FB to AGND	-0.3V to 6V
COMP to AGND	-0.3V to 6V
PGND to AGND	-0.3V to +0.3V
Junction Temperature ( $T_J$ )	+150°C
Storage Temperature ( $T_S$ )	-65°C to +150°C
ESD Rating(3)	2kV

### Recommend Operating Ratings<sup>(2)</sup>

Parameter	Units
Supply Voltage ( $V_{IN}$ )	4.5V to 16V
Output Voltage Range	0.8V to $V_{IN}$
Ambient Temperature ( $T_A$ )	-40°C to +85°C
Package Thermal Resistance SO-8 ( $\theta_{JA}$ )	87° C/W



**Electrical Characteristics**
 $T_A = 25^\circ\text{C}$ ,  $V_{IN} = V_{EN} = 12\text{V}$ ,  $V_{OUT} = 3.3\text{V}$  unless otherwise specified<sup>(4)</sup>.

Parameter	Symbol	Conditions	MIN	TYP	MAX	UNITS
Supply Voltage	$V_{IN}$		<b>4.5</b>		<b>16</b>	V
Input Under-Voltage Lockout Threshold	$V_{UVLO}$	$V_{IN}$ rising		<b>4.00</b>		V
		$V_{IN}$ falling		<b>3.70</b>		V
Supply Current (Quiescent)	$I_{IN}$	$I_{OUT} = 0$ , $V_{FB} = 1.2\text{V}$ , $V_{EN} > 2\text{V}$		<b>2</b>	<b>3</b>	mA
Shutdown Supply Current	$I_{OFF}$	$V_{EN} = 0\text{V}$		<b>3</b>	<b>20</b>	$\mu\text{A}$
Feedback Voltage	$V_{FB}$		0.782	0.8	0.818	V
Load Regulation				0.5		%
Line Regulation				1		%
Feedback Voltage Input Current	$I_{FB}$				200	nA
EN Input Threshold	$V_{EN}$	Off threshold			<b>0.6</b>	V
		On threshold	<b>2.0</b>			V
EN Input Hysteresis	$V_{HYS}$			<b>100</b>		mV
<b>Modulator</b>						
Frequency	$f_O$		350	500	600	kHz
Maximum Duty Cycle	$D_{MAX}$		100			%
Minimum Duty Cycle	$D_{MIN}$				6	%
Error Amplifier Voltage Gain				500		V/V
Error Amplifier Transconductance				200		$\mu\text{A/V}$
<b>Protection</b>						
Current Limit	$I_{LIM}$		2.5		3.6	A
Over-Temperature Shutdown Limit		$T_J$ rising		145		$^\circ\text{C}$
		$T_J$ falling		100		$^\circ\text{C}$
Soft Start Interval	$t_{SS}$			4		ms
<b>Output Stage</b>						
High-Side Switch On-Resistance		$V_{IN} = 12\text{V}$		<b>97</b>	<b>130</b>	$\text{m}\Omega$
		$V_{IN} = 5\text{V}$		<b>166</b>	<b>200</b>	$\text{m}\Omega$

**Notes:**

- Exceeding the Absolute Maximum ratings may damage the device.
- The device is not guaranteed to operate beyond the Maximum Operating ratings.
- Devices are inherently ESD sensitive, handling precautions are required. Human body model rating: 1.5K $\Omega$  in series with 100pF.
- Specification in BOLD indicate an ambient temperature range of  $-40^\circ\text{C}$  to  $+85^\circ\text{C}$ . These specifications are guaranteed by design.

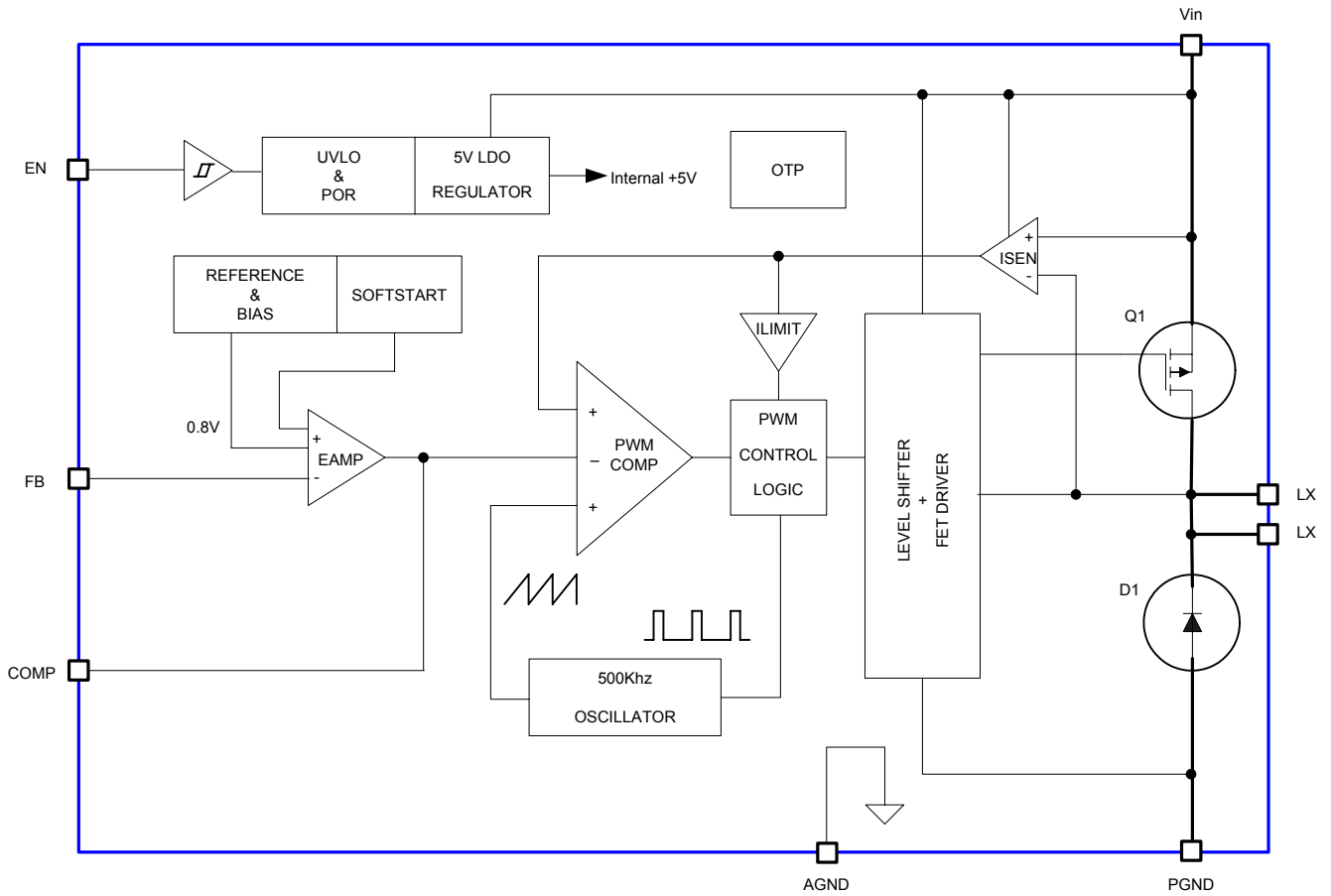
**Functional Block Diagram**



**Typical Performance Characteristics**

Circuit of figure 1.  $T_A = 25^\circ\text{C}$ ,  $V_{IN} = V_{EN} = 12\text{V}$ ,  $V_{OUT} = 3.3\text{V}$  unless otherwise specified.

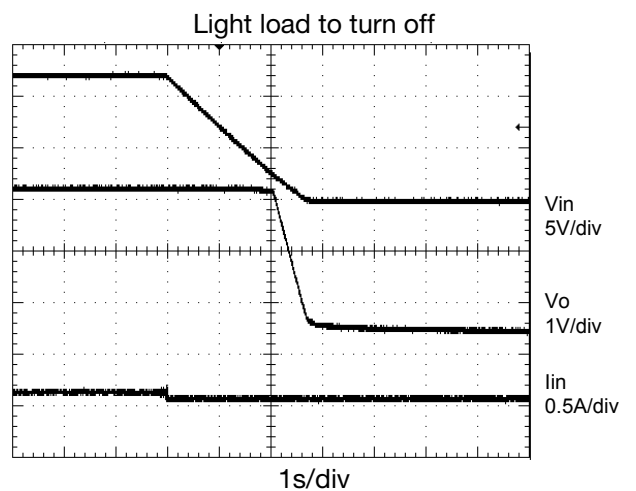
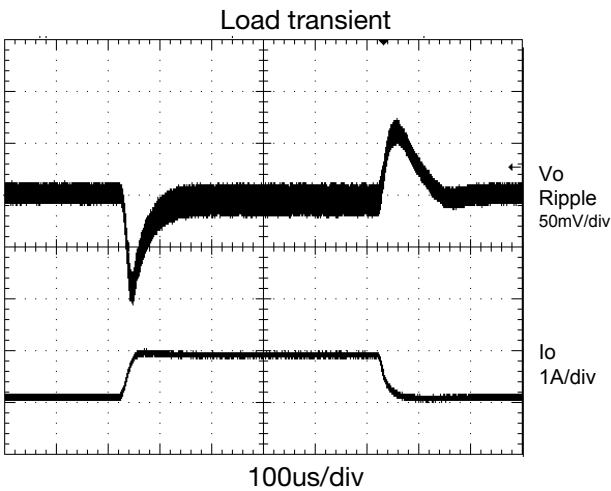
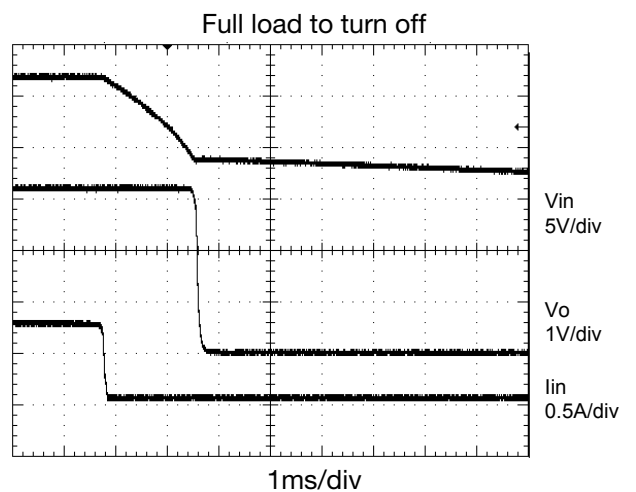
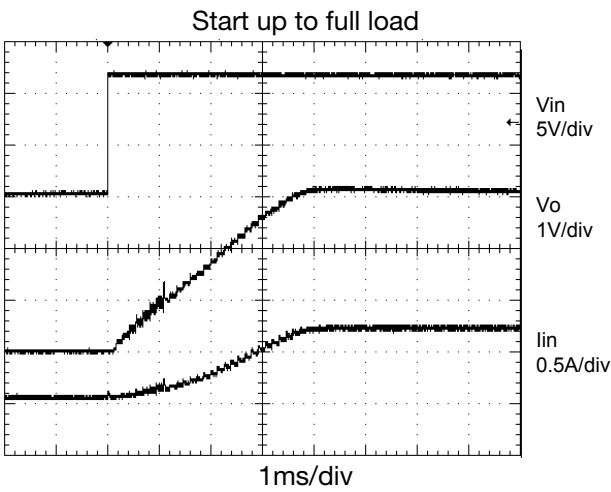
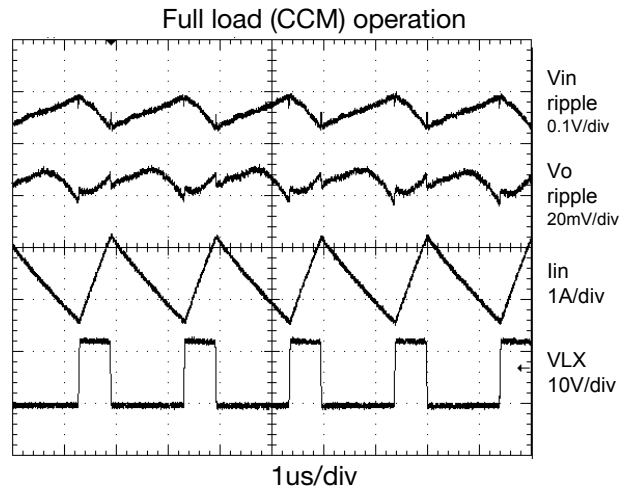
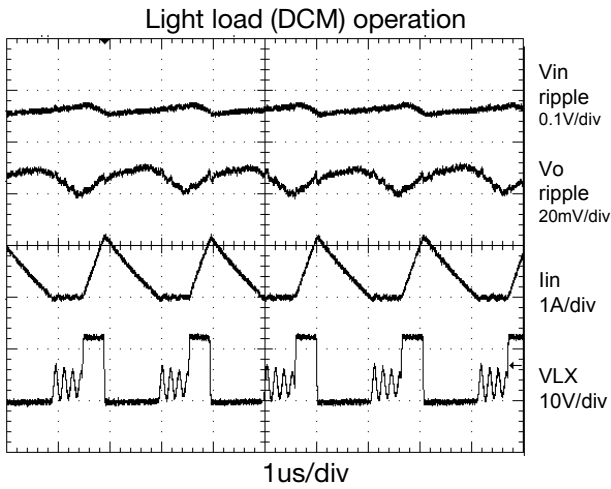

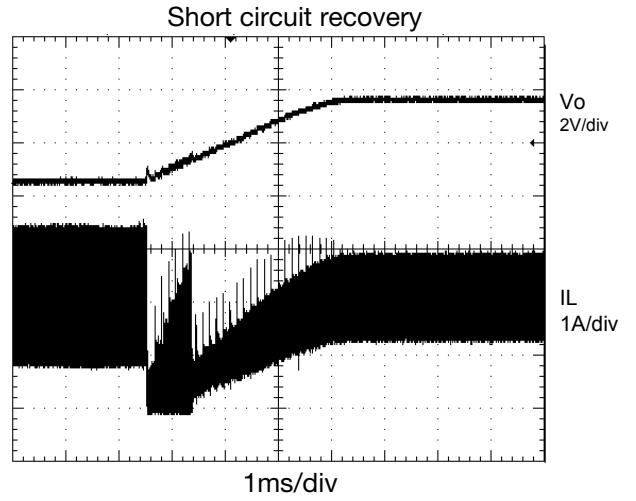
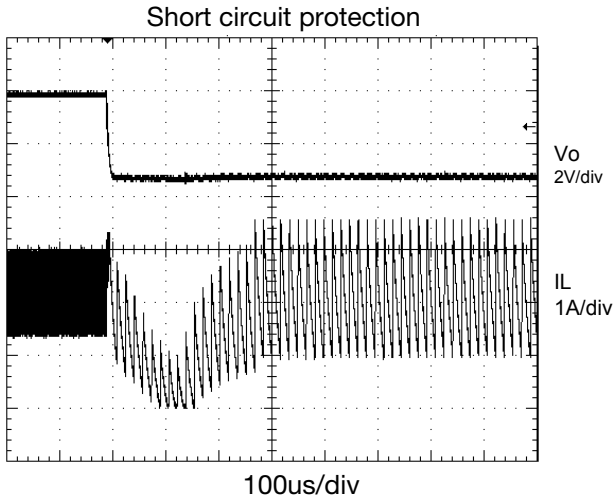

Efficiency (Vin=12V) vs. load current

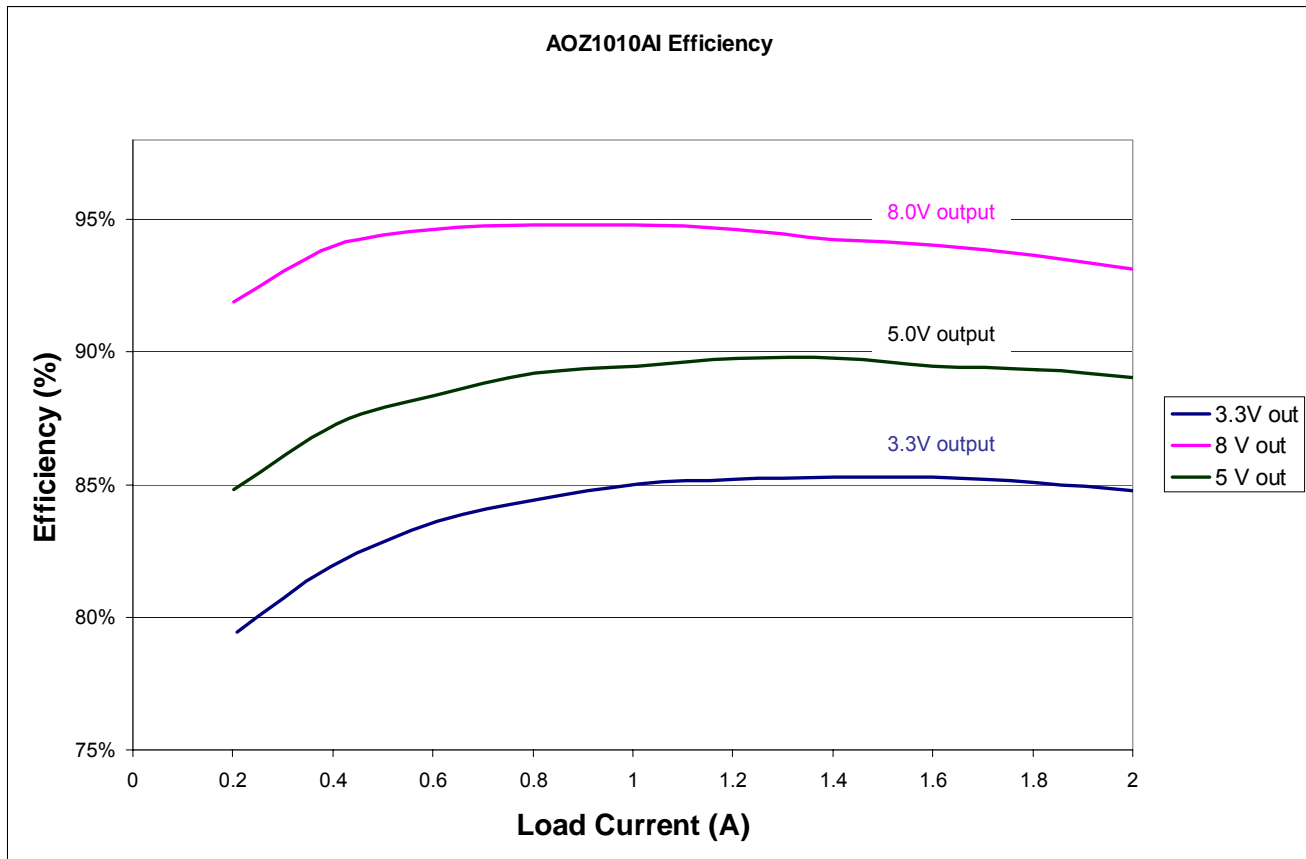

**Thermal de-rating curves for SO-8 package part under typical input and output condition**

Circuit of figure 1. 25°C ambient temperature and natural convection (air speed<50LFM) unless otherwise specified.

AOZ1010AI De-rating curves at 5V input

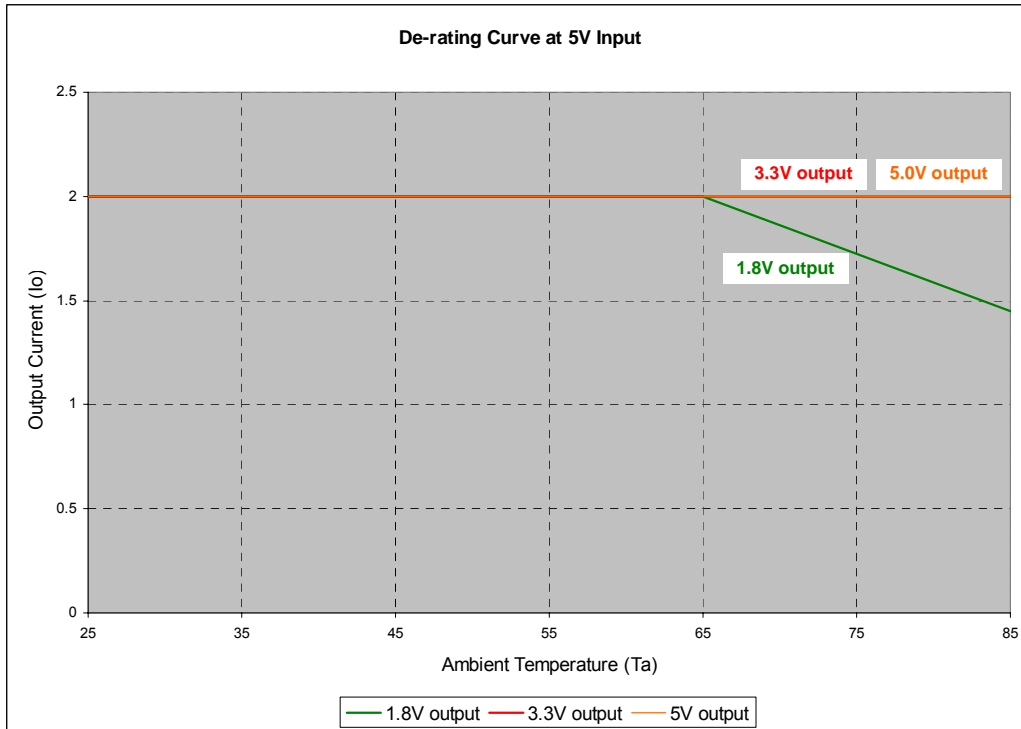

AOZ1010 De-rating curves at 12V input

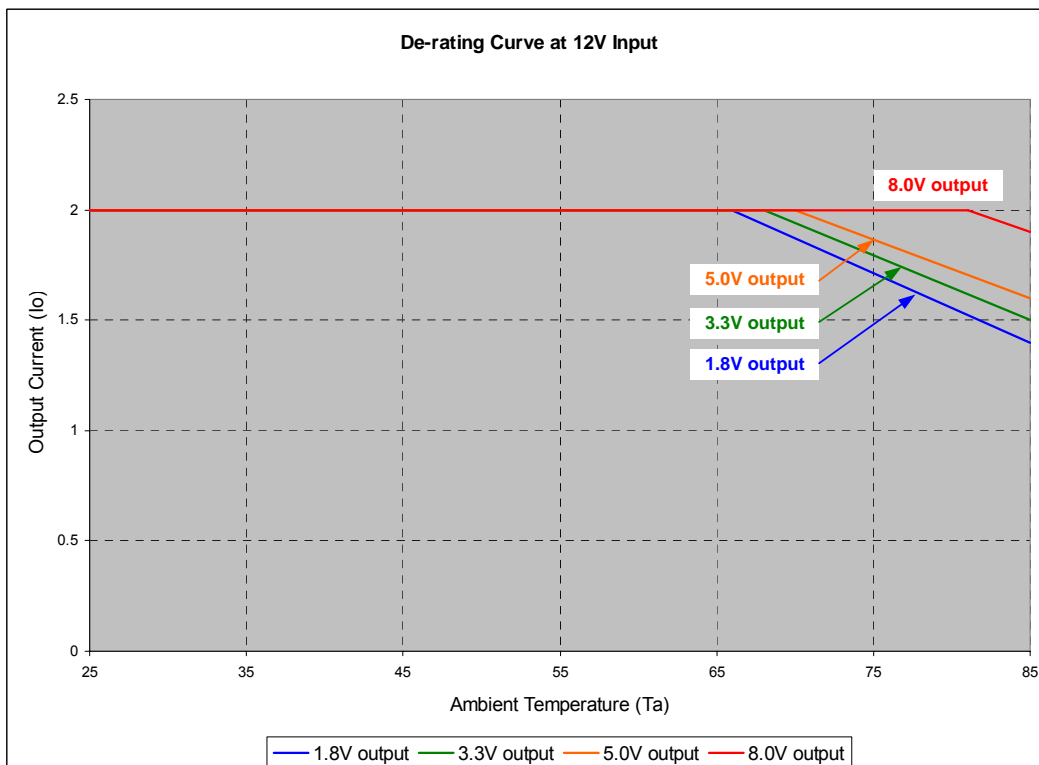



### Detailed Description

The AOZ1010 is a current-mode step down regulator with integrated high side PMOS switch and a low side freewheeling Schottky diode. It operates from a 4.5V to 16V input voltage range and supplies up to 2A of load current. The duty cycle can be adjusted from 6% to 100% allowing a wide range of output voltage. Features include enable control, Power-On Reset, input under voltage lockout, fixed internal soft-start and thermal shut down.

The AOZ1010 is available in SO-8 package.

### Enable and Soft Start

The AOZ1010 has internal soft start feature to limit in-rush current and ensure the output voltage ramps up smoothly to regulation voltage. A soft start process begins when the input voltage rises to 4.0V and voltage on EN pin is HIGH. In soft start process, the output voltage is ramped to regulation voltage in typically 4ms. The 4ms soft start time is set internally.

The EN pin of the AOZ1010 is active high. Connect the EN pin to VIN if enable function is not used. Pull it to ground will disable the AOZ1010. Do not leave it open. The voltage on EN pin must be above 2.0 V to enable the AOZ1010. When voltage on EN pin falls below 0.6V, the AOZ1010 is disabled. If an application circuit requires the AOZ1010 to be disabled, an open drain or open collector circuit should be used to interface to EN pin.

### Steady-State Operation

Under steady-state conditions, the converter operates in fixed frequency and Continuous-Conduction Mode (CCM).

The AOZ1010 integrates an internal P-MOSFET as the high-side switch. Inductor current is sensed by amplifying the voltage drop across the drain to source of the high side power MOSFET. Output voltage is divided down by the external voltage divider at the FB pin. The difference of the FB pin voltage and reference is amplified by the internal transconductance error amplifier. The error voltage, which shows on the COMP pin, is compared against the current signal, which is sum of inductor current signal and ramp compensation signal, at PWM comparator input. If the current signal is less than the error voltage, the internal high-side switch is on. The inductor current flows from the input through the inductor to the output. When the current signal exceeds the error voltage, the high-side switch is off. The inductor current is freewheeling through the internal Schottky diode to output.

The AOZ1010 uses a P-Channel MOSFET as the high side switch. It saves the bootstrap capacitor normally seen in a circuit which is using an NMOS switch. It allows 100% turn-on of the upper switch to achieve linear regulation mode of operation. The minimum voltage drop from  $V_{IN}$  to  $V_O$  is the load current times DC resistance of MOSFET plus DC resistance of buck inductor. It can be calculated by equation below:

$$V_{O\_MAX} = V_{IN} - I_O \times (R_{DS(ON)} + R_{inductor})$$

Where  $V_{O\_MAX}$  is the maximum output voltage;  
 $V_{IN}$  is the input voltage from 4.5V to 16V;  
 $I_O$  is the output current from 0A to 2A;  
 $R_{DS(ON)}$  is the on resistance of internal MOSFET, the value is between 97m  $\Omega$  and 200m  $\Omega$  depending on input voltage and junction temperature;  
 $R_{inductor}$  is the inductor DC resistance;

### Switching Frequency

The AOZ1010 switching frequency is fixed and set by an internal oscillator. The actual switching frequency could range from 350kHz to 600kHz due to device variation.

### Output Voltage Programming

Output voltage can be set by feeding back the output to the FB pin with a resistor divider network. In the application circuit shown in Figure 1. The resistor divider network includes  $R_1$  and  $R_2$ . Usually, a design is started by picking a fixed  $R_2$  value and calculating the required  $R_1$  with equation below.

$$V_O = 0.8 \times \left(1 + \frac{R_1}{R_2}\right)$$

Some standard value of  $R_1$ ,  $R_2$  for most commonly used output voltage values are listed in Table 1.

**Table 1.**

Vo (V)	R1 (k $\Omega$ )	R2 (k $\Omega$ )
0.8	1.0	open
1.2	4.99	10
1.5	10	11.5
1.8	12.7	10.2
2.5	21.5	10
3.3	31.6	10
5.0	52.3	10

Combination of  $R_1$  and  $R_2$  should be large enough to avoid drawing excessive current from the output, which will cause power loss.



Since the switch duty cycle can be as high as 100%, the maximum output voltage can be set as high as the input voltage minus the voltage drop on upper PMOS and inductor.

### Protection Features

The AOZ1010 has multiple protection features to prevent system circuit damage under abnormal conditions.

### Over Current Protection (OCP)

The sensed inductor current signal is also used for over current protection. Since the AOZ1010 employs peak current mode control, the COMP pin voltage is proportional to the peak inductor current. The COMP pin voltage is limited to be between 0.4V and 2.5V internally. The peak inductor current is automatically limited cycle by cycle.

The cycle by cycle current limit threshold is set between 2.5A and 3.6A. When the load current reaches the current limit threshold, the cycle by cycle current limit circuit turns off the high side switch immediately to terminate the current duty cycle. The inductor current stop rising. The cycle by cycle current limit protection directly limits inductor peak current. The average inductor current is also limited due to the limitation on peak inductor current. When cycle by cycle current limit circuit is triggered, the output voltage drops as the duty cycle decreasing.

The AOZ1010 has internal short circuit protection to protect itself from catastrophic failure under output short circuit conditions. The FB pin voltage is proportional to the output voltage. Whenever FB pin voltage is below 0.2V, the short circuit protection circuit is triggered. As a result, the converter is shut down and hiccups at a frequency equals to 1/8 of normal switching frequency. The converter will start up via a soft start once the short circuit condition disappears. In short circuit protection mode, the inductor average current is greatly reduced because of the low hiccup frequency.

### Power-On Reset (POR)

A power-on reset circuit monitors the input voltage. When the input voltage exceeds 4V, the converter starts operation. When input voltage falls below 3.7V, the converter will stop switching.

### Thermal Protection

An internal temperature sensor monitors the junction temperature. It shuts down the internal control circuit and high side PMOS if the junction temperature exceeds 145°C. The regulator will restart automatically under the control of soft-start circuit when the junction temperature decreases to 100°C.

### Application Information

The basic AOZ1010 application circuit is shown in Figure 1. Component selection is explained below.

#### Input capacitor

The input capacitor must be connected to the  $V_{IN}$  pin and PGND pin of the AOZ1010 to maintain steady input voltage and filter out the pulsing input current. The voltage rating of input capacitor must be greater than maximum input voltage plus ripple voltage.

The input ripple voltage can be approximated by equation below:

$$\Delta V_{IN} = \frac{I_O}{f \times C_{IN}} \times \left(1 - \frac{V_O}{V_{IN}}\right) \times \frac{V_O}{V_{IN}}$$

Since the input current is discontinuous in a buck converter, the current stress on the input capacitor is another concern when selecting the capacitor. For a buck circuit, the RMS value of input capacitor current can be calculated by:

$$I_{CIN\_RMS} = I_O \times \sqrt{\frac{V_O}{V_{IN}} \left(1 - \frac{V_O}{V_{IN}}\right)}$$

if let  $m$  equal the conversion ratio:

$$\frac{V_O}{V_{IN}} = m$$

The relation between the input capacitor RMS current and voltage conversion ratio is calculated and shown in Fig. 2 below. It can be seen that when  $V_O$  is half of  $V_{IN}$ ,  $C_{IN}$  is under the worst current stress. The worst current stress on  $C_{IN}$  is  $0.5 \cdot I_O$ .

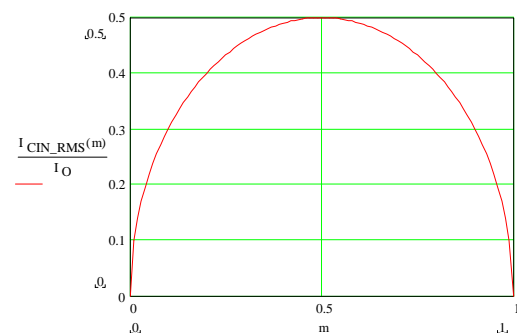

Figure 2.  $I_{CIN}$  vs. voltage conversion ratio

For reliable operation and best performance, the input capacitors must have current rating higher than  $I_{CIN\_RMS}$  at worst operating conditions. Ceramic capacitors are

preferred for input capacitors because of their low ESR and high ripple current rating. Depending on the application circuits, other low ESR tantalum capacitor may also be used. When selecting ceramic capacitors, X5R or X7R type dielectric ceramic capacitors are preferred for their better temperature and voltage characteristics. Note that the ripple current rating from capacitor manufactures are based on certain amount of life time. Further de-rating may be necessary for practical design requirement.

### Inductor

The inductor is used to supply constant current to output when it is driven by a switching voltage. For given input and output voltage, inductance and switching frequency together decide the inductor ripple current, which is,

$$\Delta I_L = \frac{V_o}{f \times L} \times \left(1 - \frac{V_o}{V_{IN}}\right)$$

The peak inductor current is:

$$I_{L_{peak}} = I_o + \frac{\Delta I_L}{2}$$

High inductance gives low inductor ripple current but requires larger size inductor to avoid saturation. Low ripple current reduces inductor core losses. It also reduces RMS current through inductor and switches, which results in less conduction loss. Usually, peak to peak ripple current on inductor is designed to be 20% to 30% of output current.

When selecting the inductor, make sure it is able to handle the peak current without saturation even at the highest operating temperature.

The inductor takes the highest current in a buck circuit. The conduction loss on inductor needs to be checked for thermal and efficiency requirements.

Surface mount inductors in different shape and styles are available from Coilcraft, Elytone and Murata. Shielded inductors are small and radiate less EMI noise. But they cost more than unshielded inductors. The choice depends on EMI requirement, price and size.

Table below lists some inductors for typical output voltage design.

**Table 2.**

Vout	L1	Manufacture
5.0 V	Unshielded, 4.7uH LQH55DN4R7M03	MURATA
	Shielded, 4.7uH LQH66SN4R7M03	MURATA
	Shield, 5.8uH ET553-5R8	ELYTONE
	Un-shielded, 6.7uH DO3316P-682MLD	Coilcraft
3.3 V	Unshielded, 4.7uH LQH55DN3R3M03	MURATA
	Shield, 4.7uH LQH66SN3R3M03	MURATA
	Shield, 3.3uH ET553-3R3	ELYTONE
	Un-shielded, 4.7uH DO3316P-472MLD	Coilcraft
	Un-shielded, 4.7uH DO1813P-472HC	Coilcraft
1.8 V	Unshielded, 2.2uH LQH55DN1R5M03	MURATA
	Shield, 2.2uH LQH66SN1R5M03	MURATA
	Shield, 2.2uH ET553-2R2	ELYTONE
	Un-shielded, 2.2uH DO3316P-222MLD	Coilcraft
	Un-shielded, 2.2uH DO1813P-222HC	Coilcraft

### Output Capacitor

The output capacitor is selected based on the DC output voltage rating, output ripple voltage specification and ripple current rating.

The selected output capacitor must have a higher rated voltage specification than the maximum desired output voltage including ripple. De-rating needs to be considered for long term reliability.

Output ripple voltage specification is another important factor for selecting the output capacitor. In a buck converter circuit, output ripple voltage is determined by inductor value, switching frequency, output capacitor value and ESR. It can be calculated by the equation below:

$$\Delta V_o = \Delta I_L \times \left(ESR_{CO} + \frac{1}{8 \times f \times C_o}\right)$$

where  $C_o$  is output capacitor value and  $ESR_{CO}$  is the Equivalent Series Resistor of output capacitor.



When low ESR ceramic capacitor is used as output capacitor, the impedance of the capacitor at the switching frequency dominates. Output ripple is mainly caused by capacitor value and inductor ripple current. The output ripple voltage calculation can be simplified to:

$$\Delta V_o = \Delta I_L \times \frac{1}{8 \times f \times C_o}$$

If the impedance of ESR at switching frequency dominates, the output ripple voltage is mainly decided by capacitor ESR and inductor ripple current. The output ripple voltage calculation can be further simplified to:

$$\Delta V_o = \Delta I_L \times ESR_{CO}$$

For lower output ripple voltage across the entire operating temperature range, X5R or X7R dielectric type of ceramic, or other low ESR tantalum are recommended to be used as output capacitors.

In a buck converter, output capacitor current is continuous. The RMS current of output capacitor is decided by the peak to peak inductor ripple current. It can be calculated by:

$$I_{CO\_RMS} = \frac{\Delta I_L}{\sqrt{12}}$$

Usually, the ripple current rating of the output capacitor is a smaller issue because of the low current stress. When the buck inductor is selected to be very small and inductor ripple current is high, output capacitor could be overstressed.

### Loop Compensation

The AOZ1010 employs peak current mode control for easy use and fast transient response. Peak current mode control eliminates the double pole effect of the output L&C filter. It greatly simplifies the compensation loop design.

With peak current mode control, the buck power stage can be simplified to be a one-pole and one-zero system in frequency domain. The pole is dominant pole and can be calculated by:

$$f_{P1} = \frac{1}{2\pi \times C_o \times R_L}$$

The zero is a ESR zero due to output capacitor and its ESR. It can be calculated by:

$$f_{Z1} = \frac{1}{2\pi \times C_o \times ESR_{CO}}$$

Where  $C_o$  is the output filter capacitor;  
 $R_L$  is load resistor value;  
 $ESR_{CO}$  is the equivalent series resistance of output capacitor;

The compensation design is actually to shape the converter close loop transfer function to get desired gain and phase. Several different types of compensation network can be used for AOZ1010. For most cases, a series capacitor and resistor network connected to the COMP pin sets the pole-zero and is adequate for a stable high-bandwidth control loop.

In the AOZ1010, FB pin and COMP pin are the inverting input and the output of internal transconductance error amplifier. A series R and C compensation network connected to COMP provides one pole and one zero. The pole is:

$$f_{P2} = \frac{G_{EA}}{2\pi \times C_c \times G_{VEA}}$$

Where  $G_{EA}$  is the error amplifier transconductance, which is  $200 \times 10^{-6} A/V$ ;  
 $G_{VEA}$  is the error amplifier voltage gain, which is 500 V/V;  
 $C_c$  is compensation capacitor;

The zero given by the external compensation network, capacitor  $C_c$  and resistor  $R_c$ , is located at:

$$f_{Z2} = \frac{1}{2\pi \times C_c \times R_c}$$

To design the compensation circuit, a target crossover frequency  $f_c$  for close loop must be selected. The system crossover frequency is where control loop has unity gain. The crossover frequency is also called the converter bandwidth. Generally a higher bandwidth means faster response to load transient. However, the bandwidth should not be too high because of system stability concern. When designing the compensation loop, converter stability under all line and load condition must be considered.

Usually, it is recommended to set the bandwidth to be less than 1/10 of switching frequency. The AOZ1010



operates at a fixed switching frequency range from 350kHz to 600kHz. It is recommended to choose a crossover frequency less than 30kHz.

$$f_c = 30kHz$$

The strategy for choosing  $R_c$  and  $C_c$  is to set the crossover frequency with  $R_c$  and set the compensator zero with  $C_c$ . Using selected crossover frequency,  $f_c$ , to calculate  $R_c$ :

$$R_c = f_c \times \frac{V_o}{V_{FB}} \times \frac{2\pi \times C_o}{G_{EA} \times G_{CS}}$$

where  $f_c$  is desired crossover frequency;

$V_{FB}$  is 0.8V;

$G_{EA}$  is the error amplifier transconductance, which is  $200 \times 10^{-6}$  A/V;

$G_{CS}$  is the current sense circuit transconductance, which is 5.64 A/V;

The compensation capacitor  $C_c$  and resistor  $R_c$  together make a zero. This zero is put somewhere close to the dominate pole  $f_{p1}$  but lower than 1/5 of selected crossover frequency.  $C_c$  can be selected by:

$$C_c = \frac{1.5}{2\pi \times R_c \times f_{p1}}$$

Equation above can also be simplified to:

$$C_c = \frac{C_o \times R_L}{R_c}$$

An easy-to-use application software which helps to design and simulate the compensation loop can be found at [www.aosmd.com](http://www.aosmd.com).

### Thermal management and layout consideration

In the AOZ1010 buck regulator circuit, high pulsing current flows through two circuit loops. The first loop starts from the input capacitors, to the VIN pin, to the LX pins, to the filter inductor, to the output capacitor and load, and then return to the input capacitor through ground. Current flows in the first loop when the high side switch is on. The second loop starts from inductor, to the output capacitors and load, to the PGND pin of the AOZ1010, to the LX pins of the AOZ1010. Current flows in the second loop when the low side diode is on.

In PCB layout, minimizing the two loops area reduces the noise of this circuit and improves efficiency. A ground plane is strongly recommended to connect input

capacitor, output capacitor, and PGND pin of the AOZ1010.

In the AOZ1010 buck regulator circuit, the two major power dissipating components are the AOZ1010 and output inductor. The total power dissipation of converter circuit can be measured by input power minus output power.

$$P_{total\_loss} = V_{IN} \cdot I_{IN} - V_o \cdot I_o$$

The power dissipation of inductor can be approximately calculated by output current and DCR of inductor.

$$P_{inductor\_loss} = I_o^2 \cdot R_{inductor} \cdot 1.1$$

The actual AOZ1010 junction temperature can be calculated with power dissipation in the AOZ1010 and thermal impedance from junction to ambient.

$$T_{junction} = (P_{total\_loss} - P_{inductor\_loss}) \cdot \Theta_{JA}$$

The maximum junction temperature of AOZ1010 is 150°C, which limits the maximum load current capability. Please see the thermal de-rating curves for the maximum load current of the AOZ1010 under different ambient temperature.

The thermal performance of the AOZ1010 is strongly affected by the PCB layout. Extra care should be taken by users during design process to ensure that the IC will operate under the recommended environmental conditions.

Several layout tips are listed below for the best electric and thermal performance. The figure 3 below illustrates a PCB layout example as reference.

1. Do not use thermal relief connection to the VIN and the PGND pin. Pour a maximized copper area to the PGND pin and the VIN pin to help thermal dissipation.
2. Input capacitor should be connected to the VIN pin and the PGND pin as close as possible.
3. A ground plane is preferred. If a ground plane is not used, separate PGND from AGND and connect them only at one point to avoid the PGND pin noise coupling to the AGND pin.
4. Make the current trace from LX pins to L to Co to the PGND as short as possible.
5. Pour copper plane on all unused board area and connect it to stable DC nodes, like VIN, GND or VOUT.

6. The two LX pins are connected to internal PFET drain. They are low resistance thermal conduction path and most noisy switching node. Connected a copper plane to LX pin to help thermal dissipation. This copper plane should not be too larger otherwise switching noise may be coupled to other part of circuit.
7. Keep sensitive signal trace far away from the LX pins.
8. The AOZ1010-EVA document provides an example of proper layout techniques.

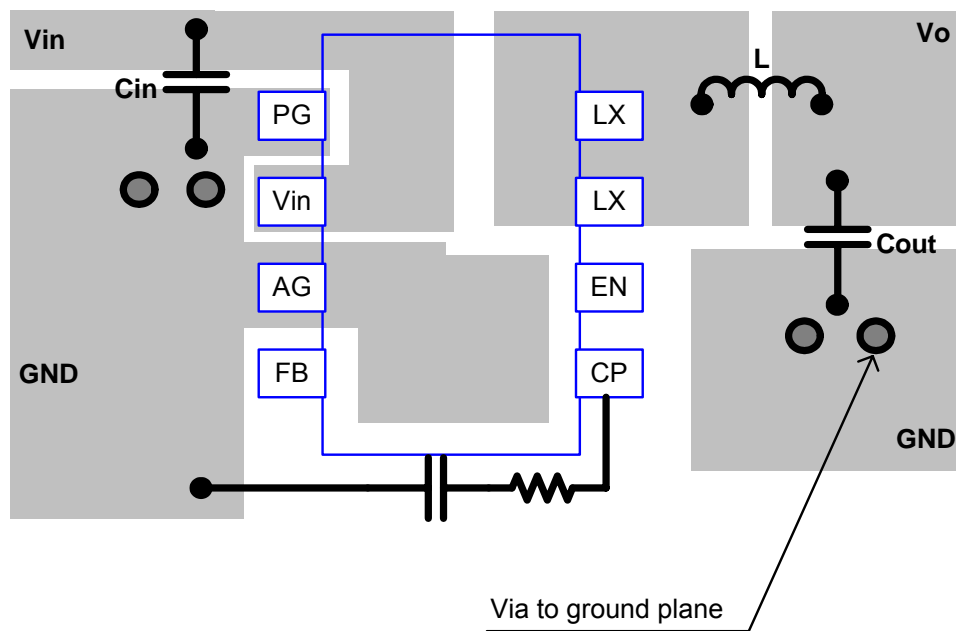
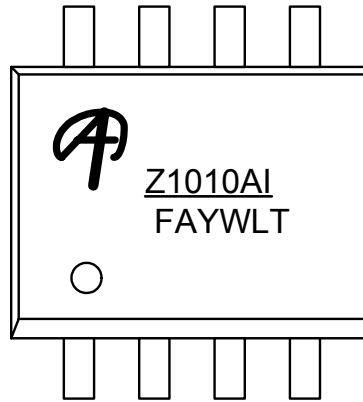

Figure 3. AOZ1010 PCB layout

### SO-8 Package Marking Description



**Note:**

Logo	AOS logo
Z1010AI	Part number code
F&A	Fab & Assembly location
Y	Year code
W	Week code
L&T	Assembly lot code

SO-8L PACKAGE OUTLINE

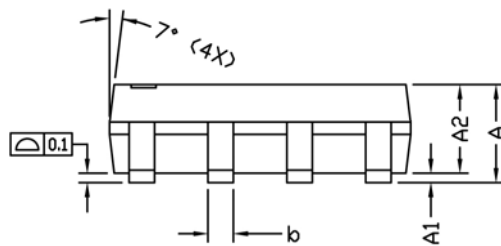
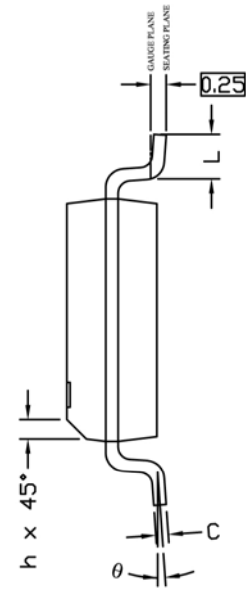
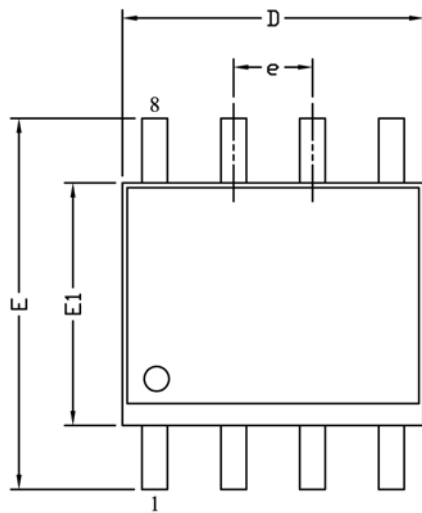

RECOMMENDED LAND PATTERN

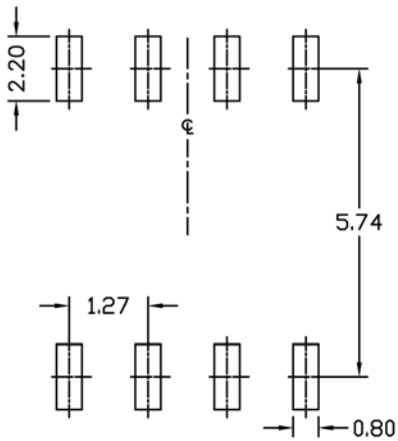

UNIT: mm

SYMBOLS	DIMENSIONS IN MILLIMETERS			DIMENSIONS IN INCHES		
	MIN	NOM	MAX	MIN	NOM	MAX
A	1.35	1.65	1.75	0.053	0.065	0.069
A1	0.10	—	0.25	0.004	—	0.010
A2	1.25	1.50	1.65	0.049	0.059	0.065
b	0.31	—	0.51	0.012	—	0.020
c	0.17	—	0.25	0.007	—	0.010
D	4.80	4.90	5.00	0.189	0.193	0.197
E1	3.80	3.90	4.00	0.150	0.154	0.157
e	1.27 BSC			0.050 BSC		
E	5.80	6.00	6.20	0.228	0.236	0.244
h	0.25	—	0.50	0.010	—	0.020
L	0.40	—	1.27	0.016	—	0.050
$\theta$	$0^\circ$	—	$8^\circ$	$0^\circ$	—	$8^\circ$





### SO-8 Tape and Reel Data

#### SO-8 Carrier Tape

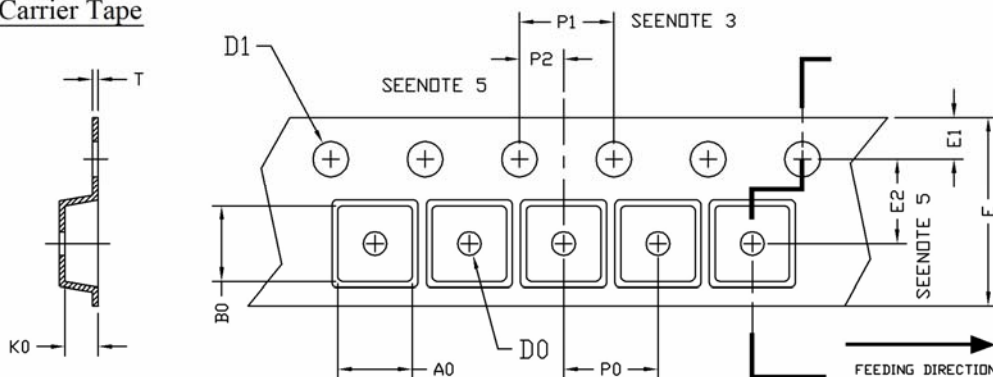

UNIT: MM

PACKAGE	A0	B0	K0	D0	D1	E	E1	E2	P0	P1	P2	T
SO-8 (12 mm)	6.40 ±0.10	5.20 ±0.10	2.10 ±0.10	1.60 ±0.10	1.50 +0.10	12.00 ±0.30	1.75 ±0.10	5.50 ±0.05	8.00 ±0.10	4.00 ±0.10	2.00 ±0.05	0.25 ±0.05

#### SO-8 Reel

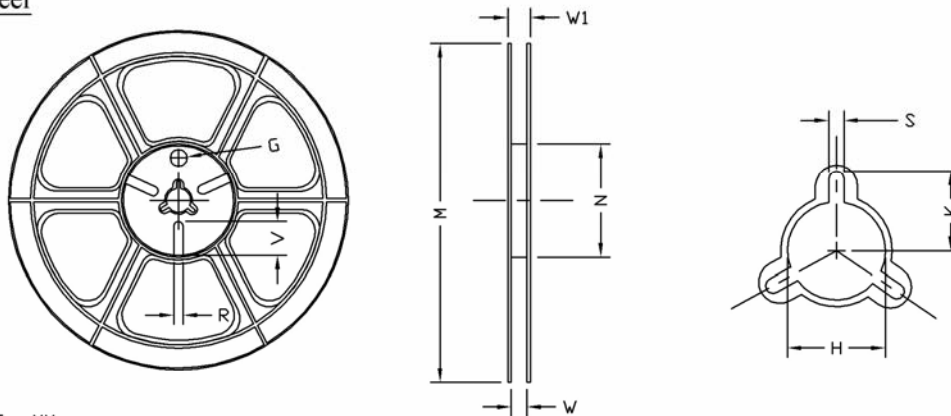

UNIT: MM

TAPE SIZE	REEL SIZE	M	N	W	W1	H	K	S	G	R	V
12 mm	∅330	∅330.00 ±0.50	∅97.00 ±0.10	13.00 ±0.30	17.40 ±1.00	∅13.00 +0.50 -0.20	10.60	2.00 ±0.50	---	---	---

#### SO-8 Tape

Leader / Trailer & Orientation

