

## General Description

The AOZ1300 is a current-limited power distribution switch intended for applications that require circuit protection. The device operates from a 2.7V to 6.0V input supply and provides up to 4A load current. AOZ1300 offers robust fault protection features including over-current/short-circuit protection and thermal overload protection. The current limit is programmable with an external resistor. An open-drain fault indicator is provided to alert a system controller of thermal overload, over-current, and short-circuit events. A 24ms fault blanking time eliminates false alarms.

The AOZ1300 employs internal soft-start circuitry to control inrush current due to highly capacitive loads associated with hot-plug events. An adjustable slew rate control pin provides additional slew rate control if needed.

The AOZ1300 is available in SO-8 package.

## Features

- 40mΩ maximum on-resistance
- 4A maximum continuous current
- 2.7V to 6.0V operating voltage
- Resistor programmable current limit
- Reverse current blocking
- Thermal overload protection
- Very fast short-circuit response time
- Fault latch with 24ms blanking time
- Open-drain fault indicator
- 1μA shutdown current

## Applications

- Docking stations
- Notebook PCs
- RAID systems
- Telecom and Server hot-plug
- USB Power Distribution
- Compact PCI adapter Cards



## Typical Application

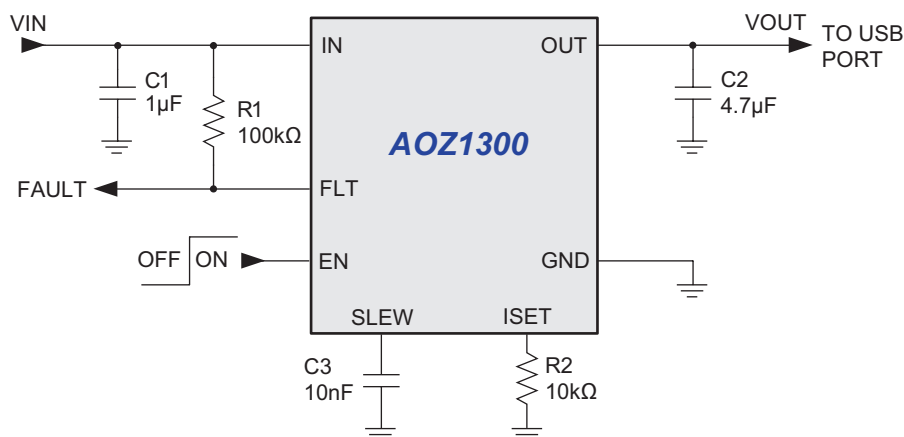

Figure 1. High Current USB Host

## Ordering Information

Part Number	Temperature Range	Package	Environmental
AOZ1300AI	-40°C to +85°C	SO-8	RoHS Compliant
AOZ1300AIL	-40°C to +85°C	SO-8	Green Product

- All AOS products are offered in packages with Pb-free plating and compliant to RoHS standards.
- Parts marked as Green Products (with “L” suffix) use reduced levels of Halogens, and are also RoHS compliant.

Please visit [www.aosmd.com/web/quality/rohs\\_compliant.jsp](http://www.aosmd.com/web/quality/rohs_compliant.jsp) for additional information.

## Pin Configuration

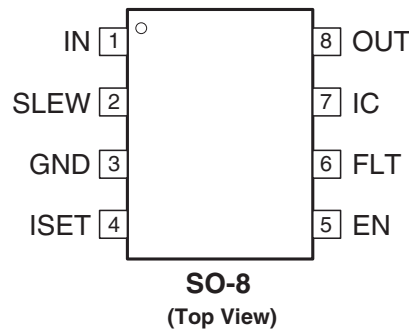

## Pin Description

Pin Number	Pin Name	Pin Function
1	IN	Switch Power Input. IN also supplies power to internal circuitry.
2	SLEW	Slew Rate Control Pin. Leaving this pin open results in a minimum output slew rate. Connect a capacitor from SLEW to GND to increase output slew rate.
3	GND	Ground.
4	ISET	Current-Limit Setting Pin. Connect a resistor from ISET to GND to set the current-limit.
5	EN	Enable Input. Pull EN high to enable the device. The part enters into low-power shutdown when EN is pulled low.
6	FLT	Fault Indicator. FLT is an open-drain output. FLT is asserted low during over-current or thermal overload events. FLT is asserted after the fault blanking period.
7	IC	Internally Connected Pin. No external connection is allowed to this pin. Leave this pin floating.
8	OUT	Switch Output Pin.

## Absolute Maximum Ratings

Exceeding the Absolute Maximum ratings may damage the device.

Parameter	Rating
IN, OUT, EN, FLT, ISET, SLEW to GND	6.5V
OUT Maximum Continuous Current	5A
Junction Temperature (T <sub>J</sub> )	+150°C
Storage Temperature (T <sub>S</sub> )	-65°C to +150°C

## Recommend Operating Ratings

The device is not guaranteed to operate beyond the Maximum Operating Ratings.

Parameter	Rating
Input Supply Voltage (V <sub>IN</sub> )	+2.7V to +6.0V
Ambient Temperature	-40°C to +85°C
SO-8 Thermal Resistance (θ <sub>JA</sub> ) <sup>(1)</sup>	87°C/W

**Note:**

1. The package θ<sub>JA</sub> is measured with the device mounted on 1-in<sup>2</sup> FR-4 printed-circuit board with 2-oz. copper in a still air environment with T<sub>A</sub> = 25°C. The value may vary depending on user's specific board design.

## Electrical Characteristics

V<sub>IN</sub> = 5V, T<sub>A</sub> = -40°C to +85°C unless otherwise stated. Typical values are at 25°C.

Symbol	Parameter	Conditions	Min.	Typ.	Max.	Units
V <sub>IN</sub>	Supply Voltage		2.7		6.0	V
I <sub>IN</sub>	Supply Current	Switch on, no load Switch off, no load		380 1	530 2	mA
V <sub>UV</sub>	Undervoltage Lockout Threshold	V <sub>IN</sub> rising	1.9	2.3	2.68	V
V <sub>UVHYS</sub>	Undervoltage Lockout Hysteresis			300		mV
V <sub>EN</sub>	Enable Input Voltage	Enable Input Low Voltage Enable Input High Voltage	2.0		0.8	V
V <sub>ENHYS</sub>	Enable Input Voltage Hysteresis			400		mV
I <sub>EN</sub>	Enable Input Current	V <sub>IN</sub> = 4.5V			1	μA
R <sub>DS(ON)</sub>	Switch On Resistance	V <sub>IN</sub> = 4.5V V <sub>IN</sub> = 2.5V		35 48	45 60	mΩ
I <sub>LIM</sub>	Short-circuit Current	R <sub>SET</sub> = 76.8kΩ, T <sub>A</sub> = +25°C to +85°C	3.2	4.0	4.8	A
I <sub>OFF</sub>	Output Leakage Current	Switch Off			1	μA
V <sub>OL</sub>	FLT Output Voltage	I <sub>OL</sub> = 5mA			0.4	V
	FLT Output Leakage Current				1	μA
t <sub>FLT</sub>	FLT Timeout Period	I <sub>LIM</sub> to FLT assertion, T <sub>A</sub> = +25°C to +85°C	18	24	30	ms
t <sub>ON</sub>	Output Turn-on Delay	R <sub>L</sub> = 10Ω, C <sub>L</sub> = 1μF		750		μs
t <sub>OFF</sub>	Output Turn-off Delay	R <sub>L</sub> = 10Ω, C <sub>L</sub> = 1μF		43		μs
t <sub>r</sub>	Output Rise-time	R <sub>L</sub> = 10Ω, C <sub>L</sub> = 1μF		460		μs
t <sub>f</sub>	Output Fall-time	R <sub>L</sub> = 10Ω, C <sub>L</sub> = 1μF		15		μs

## Typical Performance Characteristics

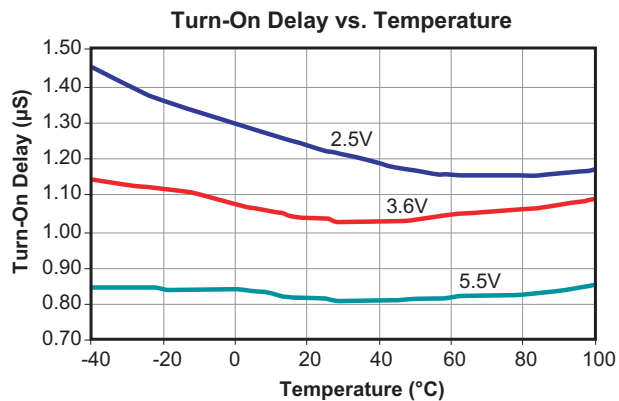
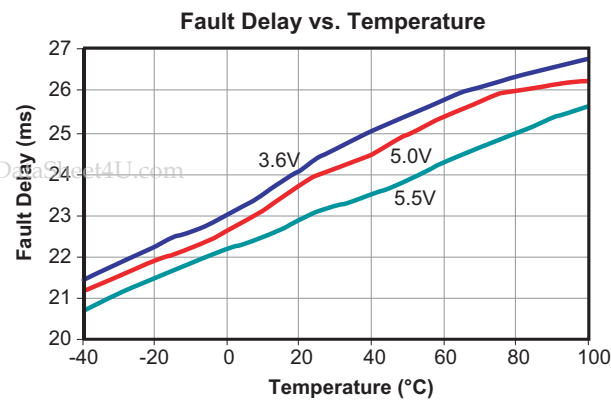
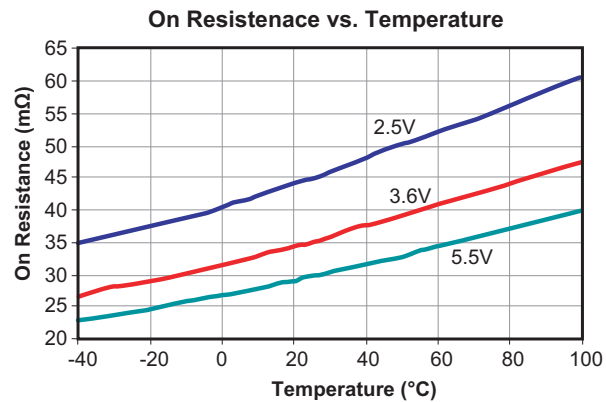
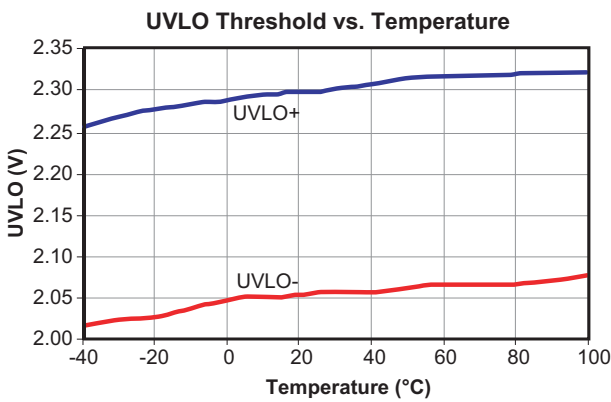
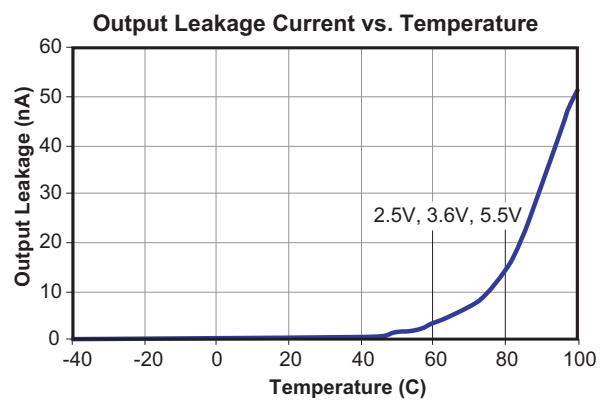
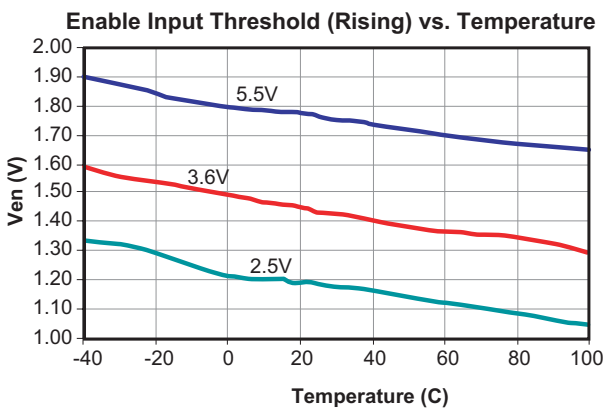
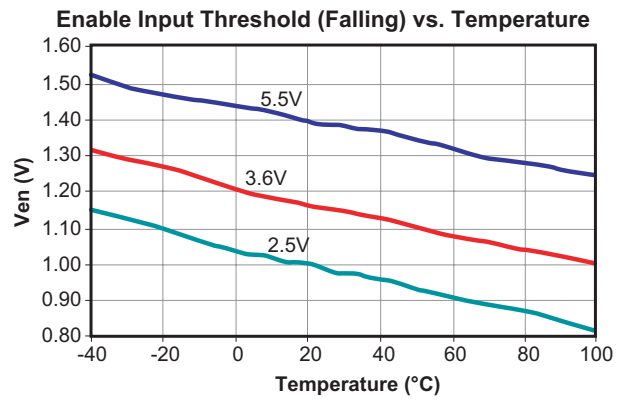
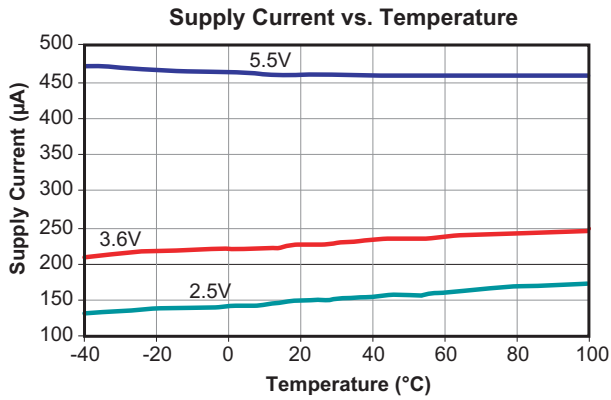

Turn-On

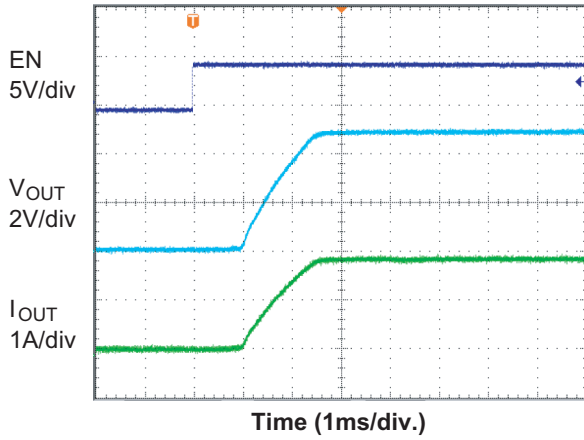

Turn-Off

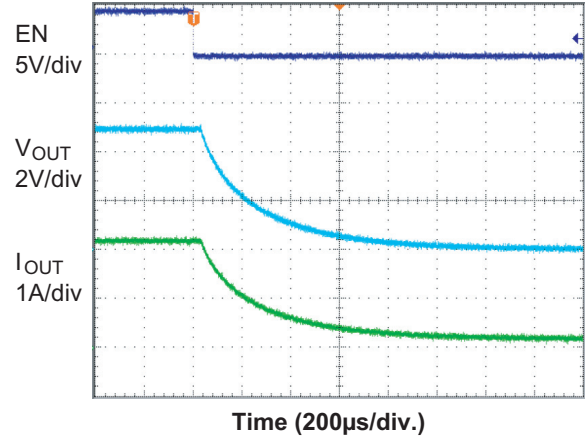

Output Slew Rate Control

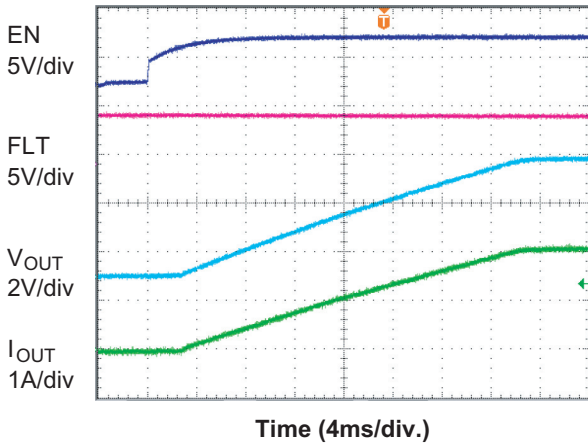

Short Circuit Response

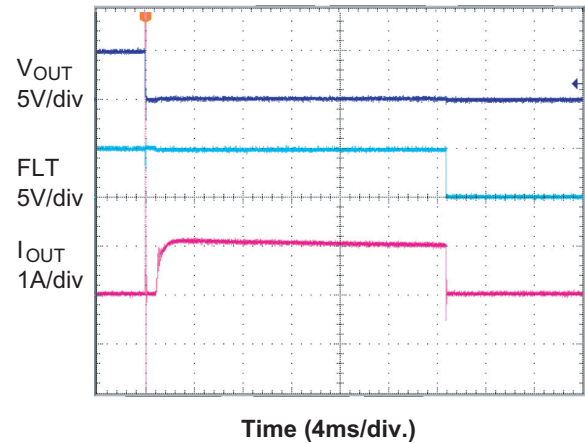

Latched Output

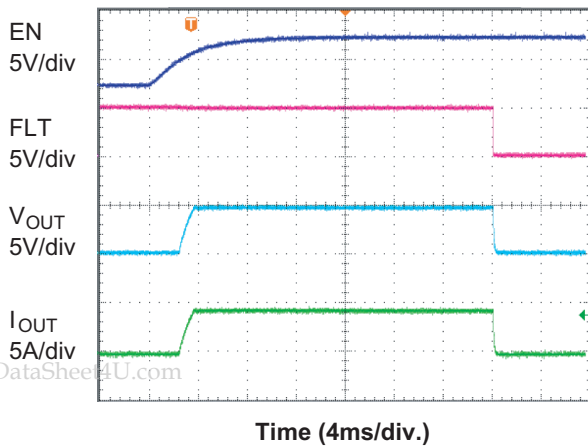

UVLO Response

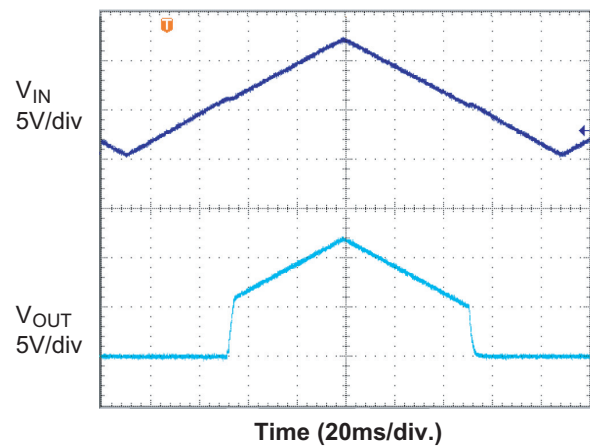

### Timing Diagrams

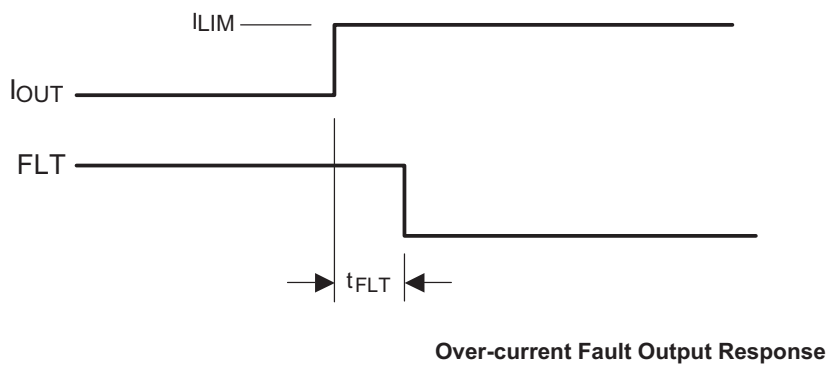
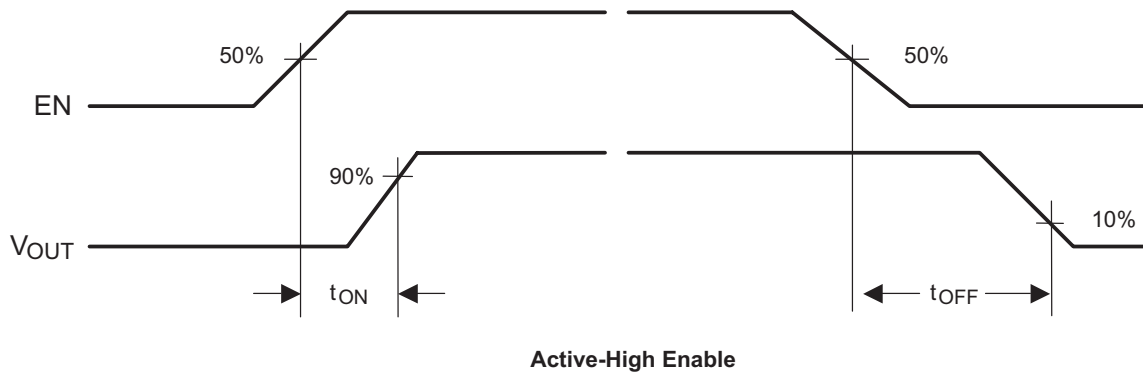

### Functional Block Diagram

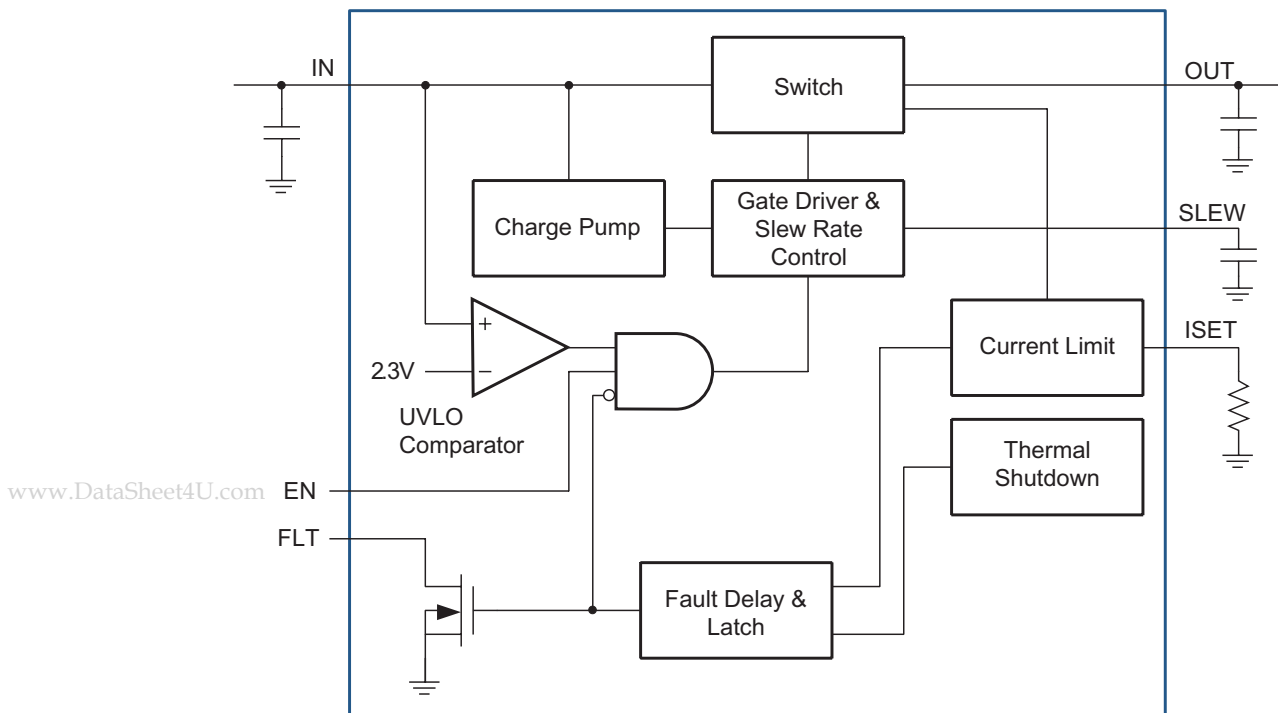

## Detailed Description

The AOZ1300 is a high-side, current-limited, N-channel MOSFET switch optimized for power distribution applications which require circuit protection. The device operates from 2.7V to 6.0V input voltage and offers current limiting and thermal overload protection. The device can be programmed for load current up to 4A using a single resistor. An open-drain fault output is provided to indicate over-current and thermal overload fault conditions. The AOZ1300's soft-start circuitry minimizes the inrush current in applications that employ highly capacitive loads. The output slew-rate may be increased with an external capacitor if longer soft-start time is desired. The AOZ1300 features a circuit breaker mode that latches the output off upon detecting an over-current condition lasting more than 24ms or detecting a thermal overload condition. The AOZ1300 features reverse current blocking function. Therefore, the output voltage can be higher than the input voltage.

### Enable

The EN pin is the ON/OFF control for the output switch. It is an active-high input. The EN pin is active after  $V_{IN}$  is above the UVLO threshold of 2.3V. Conversely, the Enable will be de-activated if the  $V_{IN}$  falls below the UVLO of 2.0V. The EN pin must be driven to a logic high or logic low state to guarantee operation. While disabled, the AOZ1300 only draws about 1 $\mu$ A supply current. The EN is a high impedance input with an ESD protection diode to ground and should not be forced below ground. This input level is compatible with most microcontroller outputs and other logic families.

### Under-Voltage Lockout (UVLO)

The under-voltage lockout (UVLO) circuit of AOZ1300 monitors the input voltage and prevents the output MOSFET from turning on until  $V_{IN}$  exceeds 2.3V. The AOZ1300 will trigger a fault condition and shut down the device when  $V_{IN}$  falls below 2.0V.

### Over-Current and Short-Circuit Protection

The AOZ1300 is designed to shut off all power to the load when the output current exceeds the limit for more than the fault blanking period. In the event of an output short circuit the current through the switch is limited by an internal current-limiting amplifier. The current-limit circuit employs a current-sensing algorithm that uses the on-state resistance of the high-side MOSFET as a current-sensing element. If the current-sense voltage is above the current-limit threshold, the AOZ1300 will turn off the internal MOSFET. The AOZ1300 has a very fast short-circuit response time, nominally 25 $\mu$ s. Once the

output shuts off, it remains off until the fault load is removed from output and the EN input is toggled or the input power is recycled. If the fault is still present after EN has been cycled, the AOZ1300 will again shut off all power to the load after 24ms.

### Thermal Overload Protection

The thermal overload protection of AOZ1300 is engaged to protect the device from damage should the die temperature exceeds safe margins due to a short circuit, extreme loading or heating from external sources. Thermal overload protection sets a fault latch and shuts off the internal MOSFET and asserts the FLT output if the junction temperature exceeds +120°C. The AOZ1300 can be re-enabled by toggling EN pin or cycling the input supply after the die temperature drops below +110°C.

### Fault Indicator

The FLT pin is an open drain output that is asserted low when either an over-current, short-circuit or thermal overload condition occurs. To prevent false alarm, the AOZ1300 implements a 24ms fault blanking time for over-current and short-circuit fault conditions. The FLT pin becomes high impedance when the fault conditions are removed. A 100k $\Omega$  pull-up resistor must be connected between FLT to  $V_{IN}$  to provide a logic signal.

### Slew Rate Control

The output voltage rise time is controlled to a minimum of 400 $\mu$ s and is controlled by an internal slew-rate limiting circuit. The slew-rate can be increased by placing a capacitor between SLEW and ground. As a result, longer rise times can be achieved for specific applications. The slew rate is independent from the load. Please see Slew Rate Setting section for detailed information.

## Applications Information

### Input and Output Capacitor Selection

The input capacitor prevents large voltage transients from appearing at the input, and provides the instantaneous current needed each time the switch turns on and to limit input voltage droop. Also it is to prevent high-frequency noise on the power line from passing through the output of the power side. The choice of the input capacitor is based on its ripple current and voltage ratings rather than its capacitor value. The input capacitor should be a low ESR type and located as close to the  $V_{IN}$  pin as possible. A 0.1 $\mu$ F 6.3V ceramic cap is recommended. However, higher capacitor values further reduce the voltage drop at the input.

The output capacitor acts in a similar way. A small 0.1µF capacitor prevents high-frequency noise from going into the system. Also, the output capacitor has to supply enough current for a large load that it may encounter during system transients. This bulk capacitor must be large enough to supply fast transient load in order to prevent the output from dropping.

### Current Limit Setting

The AOZ1300 features internal current-limiting circuitry with a maximum programmable value of 4.0A. This current limit remains in effect throughout the input supply-voltage range. The current limit is program by using external resistor connected to the ISET pin. The current-limit adjustment resistor range is from 70kΩ to 600kΩ.

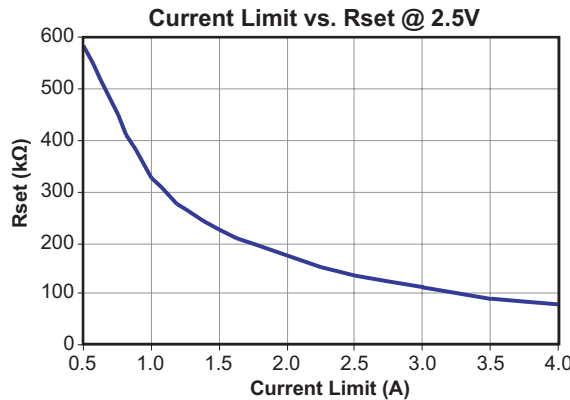
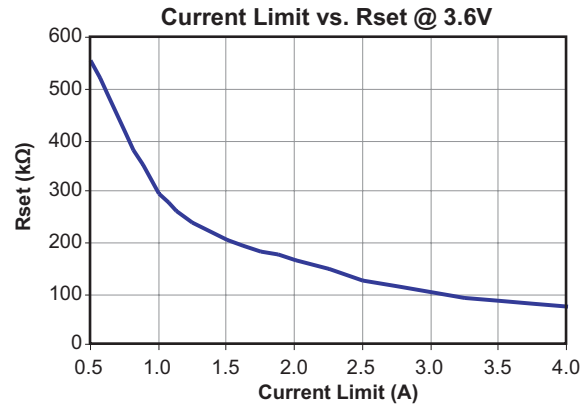
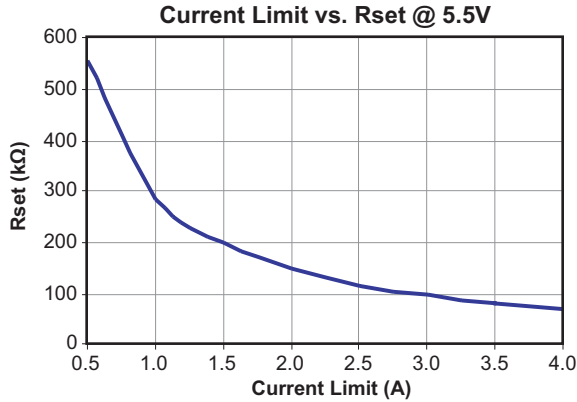

### Slew Rate Setting

Slew rate is set by changing the capacitor value on the Slew pin of the device. A capacitor connected between this pin and ground will reduce the output slew-rate. The

capacitor requires a 6.3V rating or greater. The capacitive range is 0.001µF to 0.1µF. Please see graph for Output Slew Rate Adjustment vs. Capacitance.

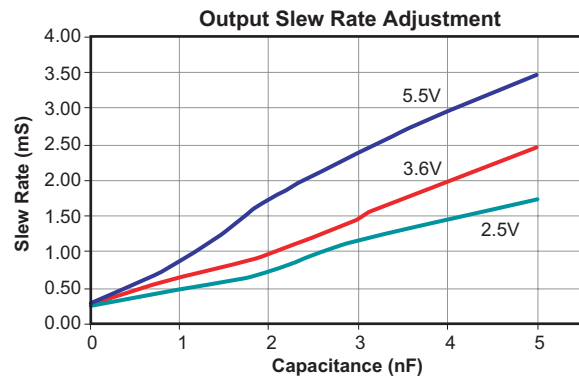
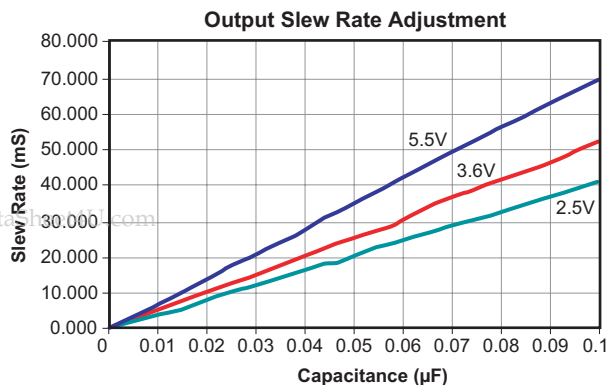



**Power Dissipation Calculation**

Calculate the power dissipation for normal load condition using the following equation:

$$P_D = R_{ON} \times (I_{OUT})^2$$

The worst case power dissipation occurs when the load current hits the current limit due to over-current or short circuit faults. The power dissipation under these conditions can be calculated using the following equation:

$$P_D = (V_{IN} - V_{OUT}) \times I_{LIMIT}$$

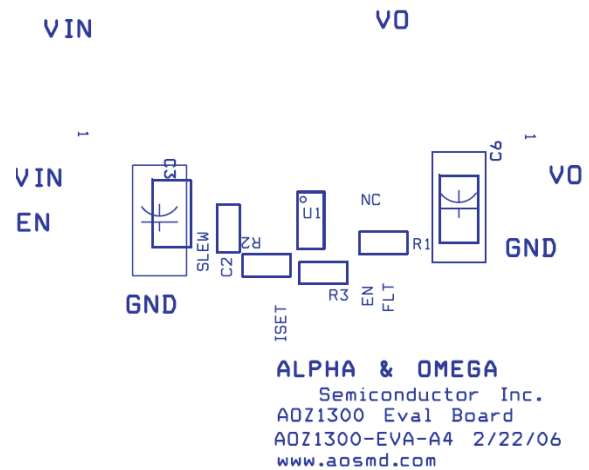

**PCB Layout Guidelines**

Proximity of passive devices and adequate power and ground planes are critical for reliable operation of the circuit. In general, use the top layer for the high current connections and the bottom or inner layer for the quiet connections such as GND. The power traces must be as short and wide as possible, because of large current. Long metal traces and component leads may cause unwanted parasitic inductance and capacitance. In order to achieve the best performance special care has to be taken for proper grounding. A good practice is always the use of a separate ground plane or at least a single point ground structure. It is recommended to use a PCB with at least two sides. It is very important to place the input and output capacitor as close as possible to the pin of the device.

**Silk Screen Top**

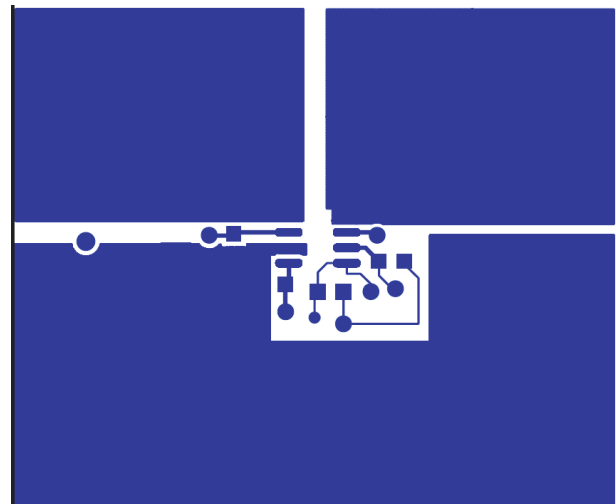

**Top Layer**

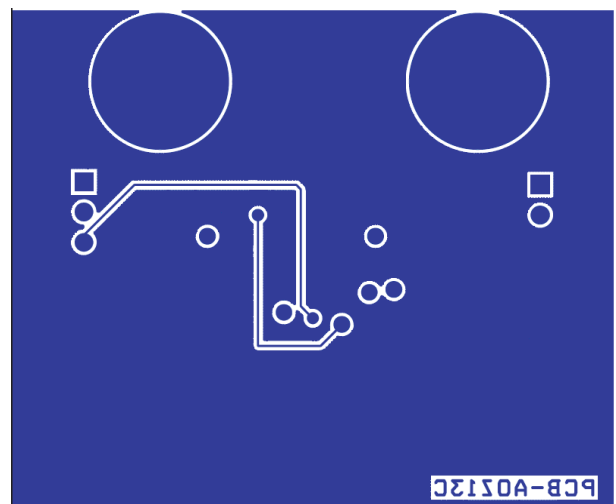

**Bottom Layer**

Package Dimensions, SO-8L

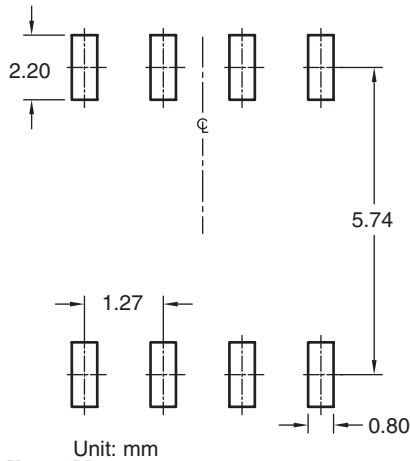
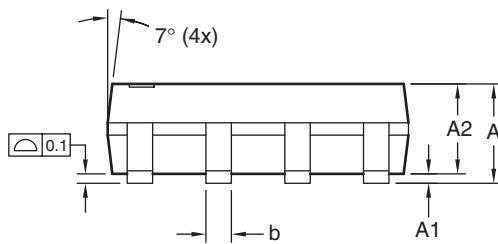
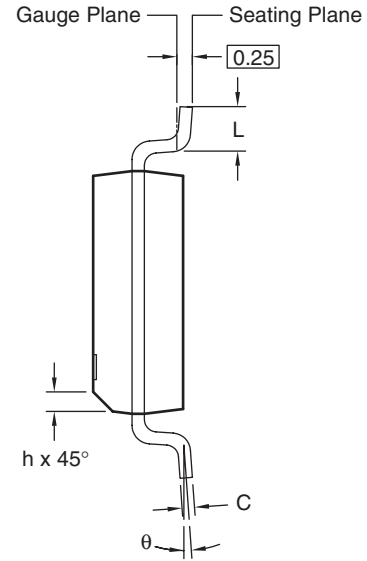
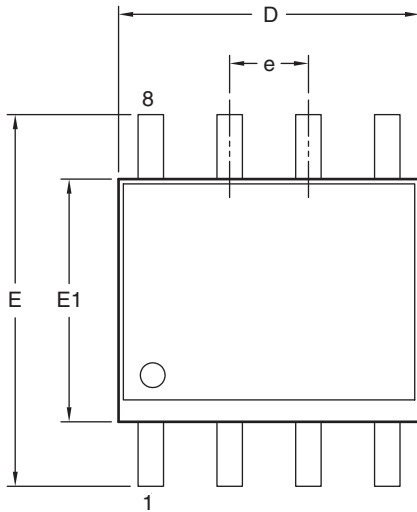

Dimensions in millimeters

Symbols	Min.	Nom.	Max.
A	1.35	1.65	1.75
A1	0.10	—	0.25
A2	1.25	1.50	1.65
b	0.31	—	0.51
c	0.17	—	0.25
D	4.80	4.90	5.00
E1	3.80	3.90	4.00
e	1.27 BSC		
E	5.80	6.00	6.20
h	0.25	—	0.50
L	0.40	—	1.27
θ	0°	—	8°

Dimensions in inches

Symbols	Min.	Nom.	Max.
A	0.053	0.065	0.069
A1	0.004	—	0.010
A2	0.049	0.059	0.065
b	0.012	—	0.020
c	0.007	—	0.010
D	0.189	0.193	0.197
E1	0.150	0.154	0.157
e	0.050 BSC		
E	0.228	0.236	0.244
h	0.010	—	0.020
L	0.016	—	0.050
θ	0°	—	8°

Notes:

1. All dimensions are in millimeters.
2. Dimensions are inclusive of plating
3. Package body sizes exclude mold flash and gate burrs. Mold flash at the non-lead sides should be less than 6 mils.
4. Dimension L is measured in gauge plane.
5. Controlling dimension is millimeter, converted inch dimensions are not necessarily exact.

## Tape and Reel Dimensions, SO-8L

### SO-8 Carrier Tape

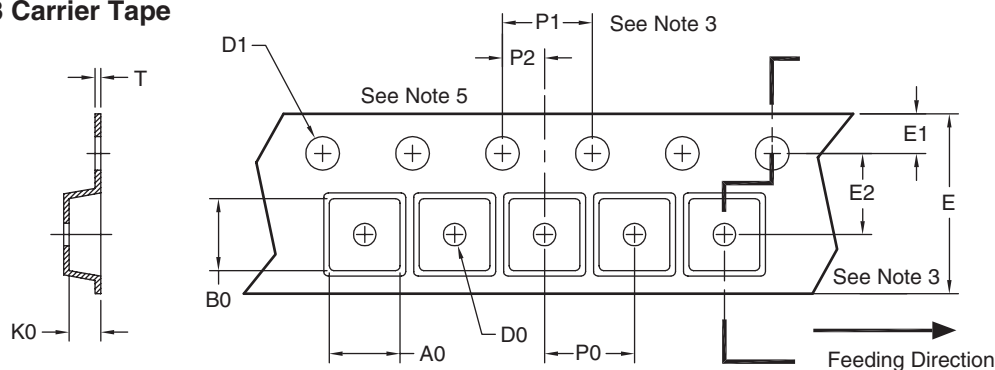

Unit: mm

Package	A0	B0	K0	D0	D1	E	E1	E2	P0	P1	P2	T
SO-8 (12mm)	6.40	5.20	2.10	1.60	1.50	12.00	1.75	5.50	8.00	4.00	2.00	0.25
	±0.10	±0.10	±0.10	±0.10	±0.10	±0.10	±0.10	±0.10	±0.10	±0.10	±0.10	±0.10

### SO-8 Reel

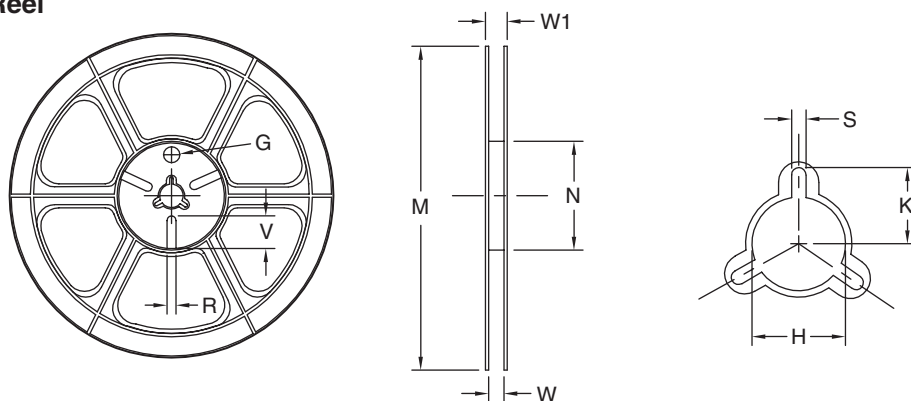

Tape Size	Reel Size	M	N	W	W1	H	K	S	G	R	V
12mm	ø330	ø330.00 ±0.50	ø97.00 ±0.10	13.00 ±0.30	17.40 ±1.00	ø13.00 +0.50/-0.20	10.60	2.00 ±0.50	—	—	—

### SO-8 Tape

Leader/Trailer  
& Orientation

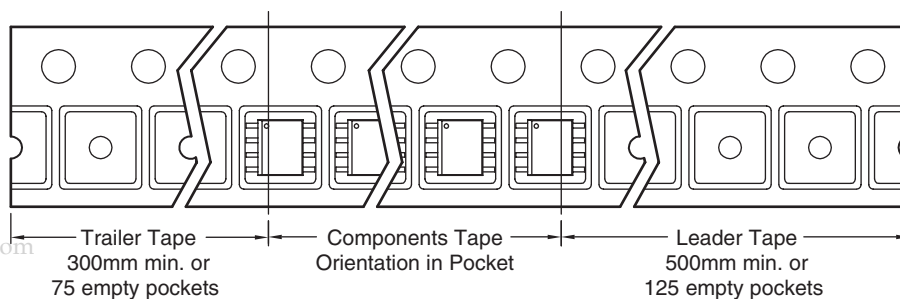

www.DataSheet4U.com

## Package Marking

