

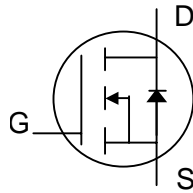

**N-channel Enhancement-mode Power MOSFET**

- 100% Avalanche-Tested**
- Simple Drive Requirement**
- Fast Switching Performance**
- RoHS-compliant, halogen-free**



$BV_{DSS}$	700V
$R_{DS(ON)}$	2.4Ω
$I_D$	4A

**Description**

Advanced Power MOSFETs from APEC provide the designer with the best combination of fast switching, low on-resistance and cost-effectiveness.

The AP04N70BP-H-HF-3 is in the TO-220 through-hole package which is widely used for commercial and industrial applications.

This device is well suited for use in high voltage applications such as off-line AC/DC converters.

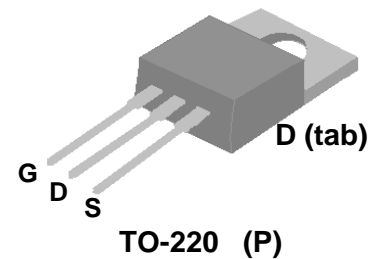

**Absolute Maximum Ratings**

Symbol	Parameter	Rating	Units
$V_{DS}$	Drain-Source Voltage	700	V
$V_{GS}$	Gate-Source Voltage	±30	V
$I_D$ at $T_C=25^\circ C$	Continuous Drain Current	4	A
$I_D$ at $T_C=100^\circ C$	Continuous Drain Current	2.5	A
$I_{DM}$	Pulsed Drain Current <sup>1</sup>	15	A
$P_D$ at $T_C=25^\circ C$	Total Power Dissipation	62.5	W
	Linear Derating Factor	0.5	W/°C
$E_{AS}$	Single Pulse Avalanche Energy <sup>3</sup>	8	mJ
$T_{STG}$	Storage Temperature Range	-55 to 150	°C
$T_J$	Operating Junction Temperature Range	-55 to 150	°C

**Thermal Data**

Symbol	Parameter	Value	Units
Rthj-c	Maximum Thermal Resistance, Junction-case	2	°C/W
Rthj-a	Maximum Thermal Resistance, Junction-ambient	40	°C/W

**Ordering Information**

**AP04N70BP-H-HF-3TB** : in RoHS-compliant halogen-free TO-220, shipped in tubes (50 pieces per tube)



**Electrical Specifications at  $T_j=25^\circ\text{C}$  (unless otherwise specified)**

Symbol	Parameter	Test Conditions	Min.	Typ.	Max.	Units
$BV_{DSS}$	Drain-Source Breakdown Voltage	$V_{GS}=0V, I_D=250\mu A$	700	-	-	V
$R_{DS(ON)}$	Static Drain-Source On-Resistance <sup>3</sup>	$V_{GS}=10V, I_D=2A$	-	-	2.4	$\Omega$
$V_{GS(th)}$	Gate Threshold Voltage	$V_{DS}=V_{GS}, I_D=250\mu A$	2	-	4	V
$g_{fs}$	Forward Transconductance	$V_{DS}=10V, I_D=2A$	-	3.6	-	S
$I_{DSS}$	Drain-Source Leakage Current	$V_{DS}=600V, V_{GS}=0V$	-	-	10	$\mu A$
	Drain-Source Leakage Current ( $T_j=125^\circ\text{C}$ )	$V_{DS}=480V, V_{GS}=0V$	-	-	500	$\mu A$
$I_{GSS}$	Gate-Source Leakage	$V_{GS}=\pm 30V, V_{DS}=0V$	-	-	$\pm 100$	nA
$Q_g$	Total Gate Charge <sup>3</sup>	$I_D=4A$	-	19	-	nC
$Q_{gs}$	Gate-Source Charge	$V_{DS}=480V$	-	4	-	nC
$Q_{gd}$	Gate-Drain ("Miller") Charge	$V_{GS}=10V$	-	6.5	-	nC
$t_{d(on)}$	Turn-on Delay Time <sup>3</sup>	$V_{DD}=300V$	-	11	-	ns
$t_r$	Rise Time	$I_D=4A$	-	9	-	ns
$t_{d(off)}$	Turn-off Delay Time	$R_G=10\Omega$	-	28	-	ns
$t_f$	Fall Time	$V_{GS}=10V$	-	12	-	ns
$C_{iss}$	Input Capacitance	$V_{GS}=0V$	-	950	-	pF
$C_{oss}$	Output Capacitance	$V_{DS}=25V$	-	75	-	pF
$C_{rss}$	Reverse Transfer Capacitance	$f=1.0\text{MHz}$	-	6	-	pF

**Source-Drain Diode**

Symbol	Parameter	Test Conditions	Min.	Typ.	Max.	Units
$V_{SD}$	Forward On Voltage <sup>3</sup>	$I_S=4A, V_{GS}=0V$	-	-	1.5	V
$t_{rr}$	Reverse Recovery Time <sup>3</sup>	$I_S=4A, V_{GS}=0V,$	-	500	-	ns
$Q_{rr}$	Reverse Recovery Charge	$dI/dt=100A/\mu s$	-	3.8	-	$\mu C$

**Notes:**

1. Pulse width limited by maximum junction temperature.
2. Starting  $T_j=25^\circ\text{C}$ ,  $V_{DD}=50V$ ,  $L=1\text{mH}$ ,  $R_G=25\Omega$ ,  $I_{AS}=4A$
3. Pulse test

THIS PRODUCT IS SENSITIVE TO ELECTROSTATIC DISCHARGE, PLEASE HANDLE WITH CAUTION.

USE OF THIS PRODUCT AS A CRITICAL COMPONENT IN LIFE SUPPORT OR OTHER SIMILAR SYSTEMS IS NOT AUTHORIZED.

APEC DOES NOT ASSUME ANY LIABILITY ARISING OUT OF THE APPLICATION OR USE OF ANY PRODUCT OR CIRCUIT DESCRIBED HEREIN; NEITHER DOES IT CONVEY ANY LICENSE UNDER ITS PATENT RIGHTS, NOR THE RIGHTS OF OTHERS.

APEC RESERVES THE RIGHT TO MAKE CHANGES WITHOUT FURTHER NOTICE TO ANY PRODUCTS HEREIN TO IMPROVE RELIABILITY, FUNCTION OR DESIGN.



Typical Electrical Characteristics

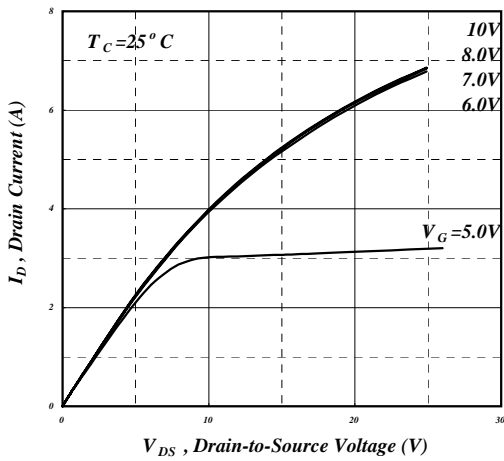

Fig 1. Typical Output Characteristics

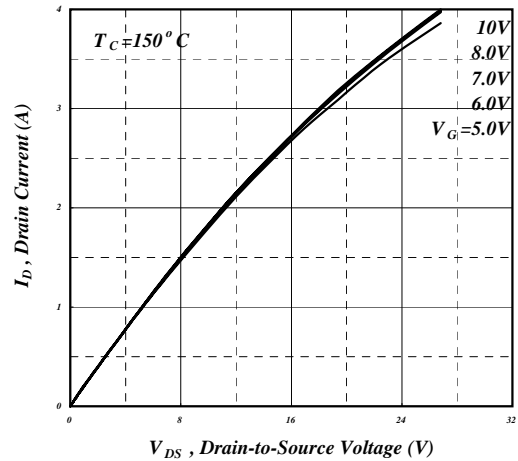

Fig 2. Typical Output Characteristics

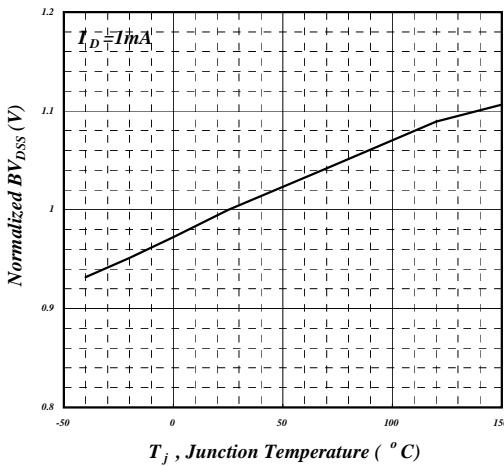

Fig 3. Normalized  $BV_{DSS}$  vs. Junction Temperature

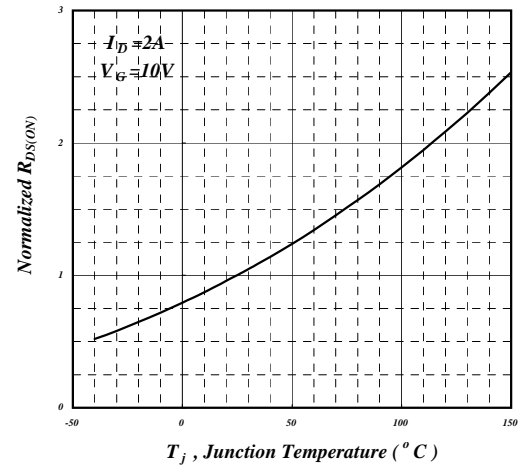

Fig 4. Normalized On-Resistance vs. Junction Temperature

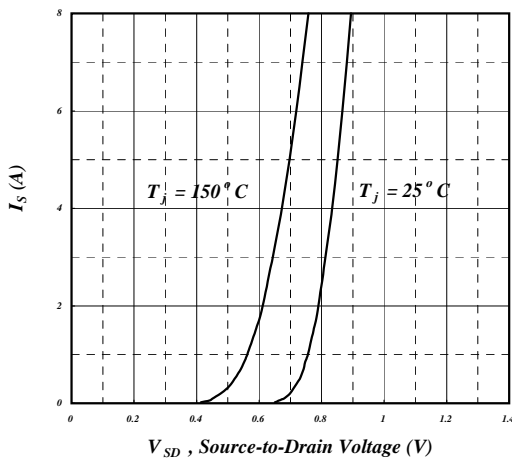

Fig 5. Forward Characteristic of Reverse Diode

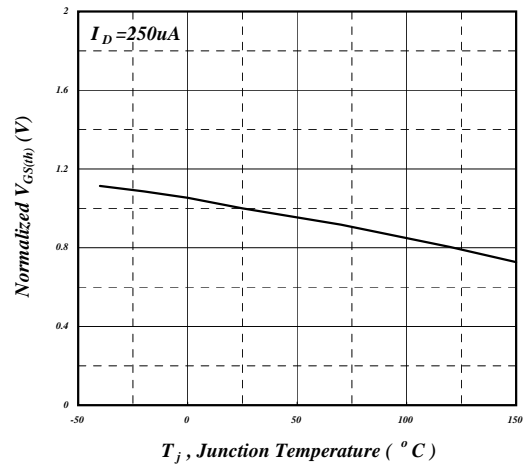

Fig 6. Gate Threshold Voltage vs. Junction Temperature



Typical Electrical Characteristics (cont.)

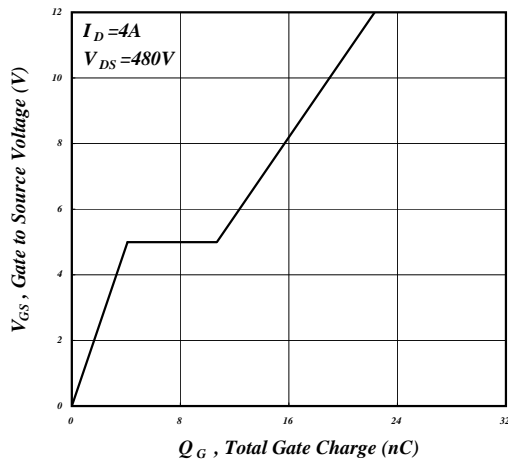

Fig 7. Gate Charge Characteristics

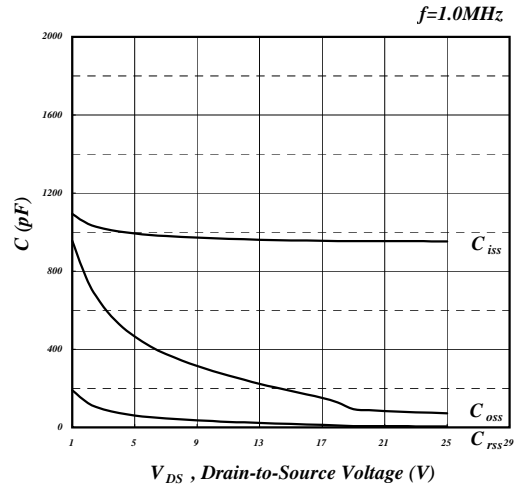

Fig 8. Typical Capacitance Characteristics

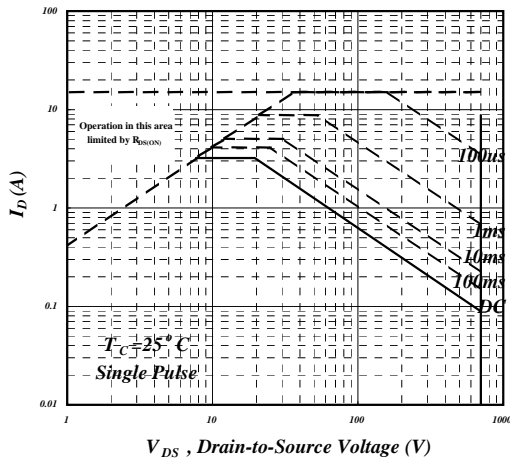

Fig 9. Maximum Safe Operating Area

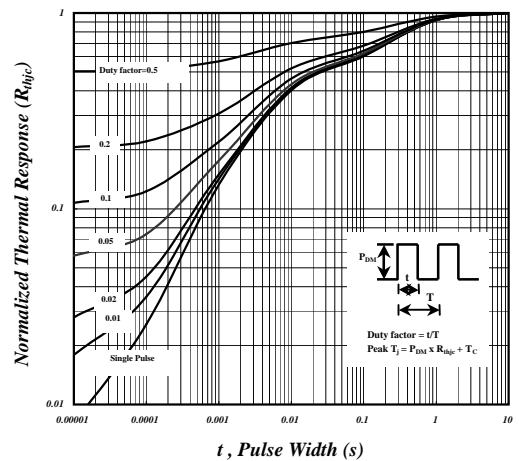

Fig 10. Effective Transient Thermal Impedance

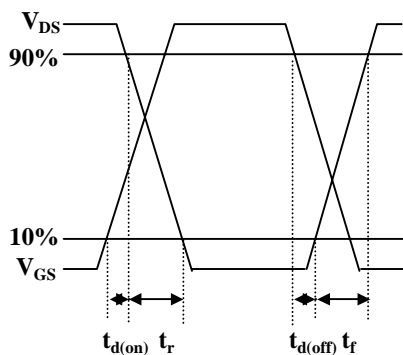

Fig 11. Switching Time Waveforms

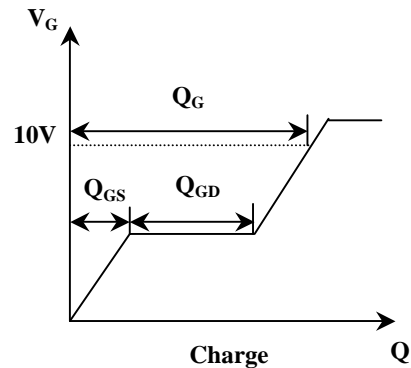
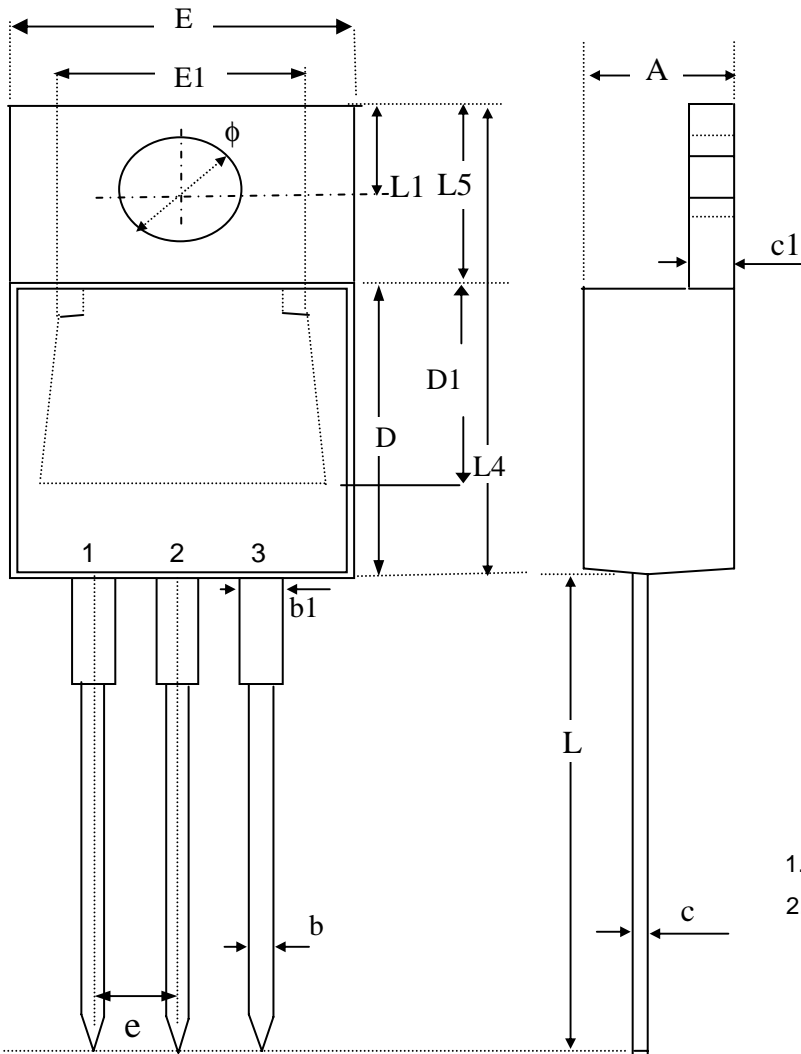

Fig 12. Gate Charge Waveform



**Package Dimensions: TO-220**



SYMBOLS	Millimeters		
	MIN	NOM	MAX
A	4.40	4.60	4.80
b	0.76	0.88	1.00
D	8.60	8.80	9.00
c	0.36	0.43	0.50
E	9.80	10.10	10.40
L4	14.70	15.00	15.30
L5	6.20	6.40	6.60
D1	5.10 REF.		
c1	1.25	1.35	1.45
b1	1.17	1.32	1.47
L	13.25	13.75	14.25
e	2.54 REF.		
L1	2.60	2.75	2.89
phi	3.71	3.84	3.96
E1	7.4 REF.		

1. All dimensions are in millimeters.
2. Dimensions do not include mold protrusions.

**Marking Information:**

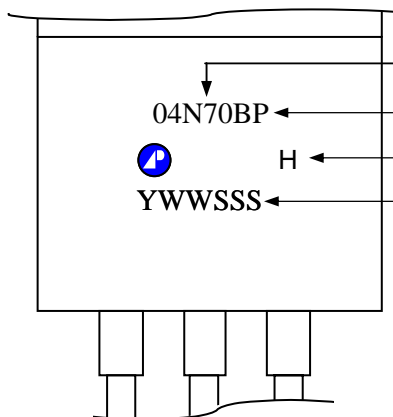

Product: AP04N70B

04N70BP



YWWSSS

H

Package code: P = RoHS-compliant halogen-free TO-220

Voltage grade H = 700V

Date Code (YWWSSS)

Y : Last digit of the year

WW : Work week

SSS : Lot code sequence