

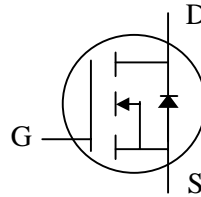

**N-channel Enhancement-mode Power MOSFET**

- RoHS-compliant, Halogen-free**
- Low Conductance Losses**
- Fast Switching Performance**
- Low Profile (< 0.7mm )**



|              |       |
|--------------|-------|
| $BV_{DSS}$   | 30V   |
| $R_{DS(ON)}$ | 1.8mΩ |
| $I_D$        | 32A   |

**Description**

The AP1002BMX-3 uses the latest APEC Power MOSFET silicon technology with advanced technology GreenFET™ packaging to provide the lowest on-resistance, a low profile and dual-sided cooling capability.

The GreenFET™ package is compatible with existing soldering techniques and is ideal for power applications, especially for high-frequency/high-efficiency DC-DC converters.

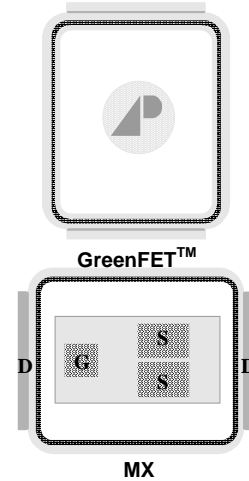

**Absolute Maximum Ratings**

| Symbol                    | Parameter                                  | Rating     | Units |
|---------------------------|--|------------|-------|
| $V_{DS}$                  | Drain-Source Voltage                       | 30         | V     |
| $V_{GS}$                  | Gate-Source Voltage                        | ±20        | V     |
| $I_D$ at $T_A=25^\circ C$ | Continuous Drain Current <sup>3</sup>      | 32         | A     |
| $I_D$ at $T_A=70^\circ C$ | Continuous Drain Current <sup>3</sup>      | 25         | A     |
| $I_D$ at $T_C=25^\circ C$ | Continuous Drain Current <sup>4</sup>      | 180        | A     |
| $I_{DM}$                  | Pulsed Drain Current <sup>1</sup>          | 250        | A     |
| $P_D$ at $T_A=25^\circ C$ | Total Power Dissipation <sup>3</sup>       | 2.8        | W     |
| $P_D$ at $T_A=70^\circ C$ | Total Power Dissipation <sup>3</sup>       | 1.8        | W     |
| $P_D$ at $T_C=25^\circ C$ | Total Power Dissipation <sup>4</sup>       | 89         | W     |
| $E_{AS}$                  | Single Pulse Avalanche Energy <sup>5</sup> | 28.8       | mJ    |
| $I_{AR}$                  | Avalanche Current                          | 24         | A     |
| $T_{STG}$                 | Storage Temperature Range                  | -40 to 150 | °C    |
| $T_J$                     | Operating Junction Temperature Range       | -40 to 150 | °C    |

**Thermal Data**

|        |   |     |      |
|--------|---|-----|------|
| Rthj-c | Maximum Thermal Resistance, Junction-case <sup>4</sup>    | 1.4 | °C/W |
| Rthj-a | Maximum Thermal Resistance, Junction-ambient <sup>3</sup> | 45  | °C/W |

**Ordering Information**

**AP1002BMX-3TR** RoHS-compliant halogen-free GreenFET™ MX package, shipped on tape and reel (4800 pcs/reel)



**Electrical Specifications at  $T_j=25^\circ\text{C}$  (unless otherwise specified)**

| Symbol       | Parameter  | Test Conditions               | Min. | Typ. | Max.      | Units      |
|--------------|--|-------------------------------|------|------|-----------|------------|
| $BV_{DSS}$   | Drain-Source Breakdown Voltage                           | $V_{GS}=0V, I_D=250\mu A$     | 30   | -    | -         | V          |
| $R_{DS(ON)}$ | Static Drain-Source On-Resistance <sup>2</sup>           | $V_{GS}=10V, I_D=32A$         | -    | 1.3  | 1.8       | m $\Omega$ |
|              |  | $V_{GS}=4.5V, I_D=25A$        | -    | 1.9  | 3         | m $\Omega$ |
| $V_{GS(th)}$ | Gate Threshold Voltage                                   | $V_{DS}=V_{GS}, I_D=250\mu A$ | 1.2  | -    | 2.35      | V          |
| $g_{fs}$     | Forward Transconductance                                 | $V_{DS}=10V, I_D=25A$         | 45   | 80   | -         | S          |
| $I_{DSS}$    | Drain-Source Leakage Current                             | $V_{DS}=24V, V_{GS}=0V$       | -    | -    | 1         | $\mu A$    |
|              | Drain-Source Leakage Current ( $T_j=125^\circ\text{C}$ ) | $V_{DS}=24V, V_{GS}=0V$       | -    | -    | 150       | $\mu A$    |
| $I_{GSS}$    | Gate-Source Leakage                                      | $V_{GS}=\pm 20V, V_{DS}=0V$   | -    | -    | $\pm 100$ | nA         |
| $Q_g$        | Total Gate Charge <sup>2</sup>                           | $I_D=25A$                     | -    | 29   | 46        | nC         |
| $Q_{gs}$     | Gate-Source Charge                                       | $V_{DS}=15V$                  | -    | 6.5  | -         | nC         |
| $Q_{gd}$     | Gate-Drain ("Miller") Charge                             | $V_{GS}=4.5V$                 | -    | 14   | -         | nC         |
| $t_{d(on)}$  | Turn-on Delay Time <sup>2</sup>                          | $V_{DS}=16V$                  | -    | 14   | -         | ns         |
| $t_r$        | Rise Time  | $I_D=25A$                     | -    | 90   | -         | ns         |
| $t_{d(off)}$ | Turn-off Delay Time                                      | $R_G=1.2\Omega, V_{GS}=10V$   | -    | 36   | -         | ns         |
| $t_f$        | Fall Time  | $R_D=0.64\Omega$              | -    | 11   | -         | ns         |
|              | Input Capacitance  | $V_{GS}=0V$                   | -    | 3350 | 5360      | pF         |
| $C_{OSS}$    | Output Capacitance                                       | $V_{DS}=25V$                  | -    | 1000 | -         | pF         |
| $C_{rss}$    | Reverse Transfer Capacitance                             | $f=1.0\text{MHz}$             | -    | 320  | -         | pF         |
| $R_g$        | Gate Resistance  | $f=1.0\text{MHz}$             | -    | 1.3  | -         | $\Omega$   |

**Source-Drain Diode**

| Symbol   | Parameter                                       | Test Conditions       | Min. | Typ. | Max. | Units |
|----------|---|-----------------------|------|------|------|-------|
| $I_S$    | Continuous Source Current (Body Diode)          |                       | -    | -    | 110  | A     |
| $I_{SM}$ | Pulsed Source Current (Body Diode) <sup>1</sup> |                       | -    | -    | 250  | A     |
| $V_{SD}$ | Forward On Voltage <sup>2</sup>                 | $I_S=25A, V_{GS}=0V$  | -    | -    | 1    | V     |
| $t_{rr}$ | Reverse Recovery Time                           | $I_S=25A, V_{GS}=0V,$ | -    | 55   | 83   | ns    |
| $Q_{rr}$ | Reverse Recovery Charge                         | $di/dt=100A/\mu s$    | -    | 75   | 113  | nC    |

**Notes:**

1. Pulse width limited by maximum junction temperature.
2. Pulse test
3. Surface mounted on 1 in<sup>2</sup> copper pad of FR4 board.
4.  $T_C$  measured with thermocouple mounted to top (Drain) of part.
5. Starting  $T_j=25^\circ\text{C}$ ,  $L=0.1\text{mH}$ ,  $R_G=25\Omega$

THIS PRODUCT IS SENSITIVE TO ELECTROSTATIC DISCHARGE, PLEASE HANDLE WITH CAUTION.

USE OF THIS PRODUCT AS A CRITICAL COMPONENT IN LIFE SUPPORT OR OTHER SIMILAR SYSTEMS IS NOT AUTHORIZED.

APEC DOES NOT ASSUME ANY LIABILITY ARISING OUT OF THE APPLICATION OR USE OF ANY PRODUCT OR CIRCUIT DESCRIBED HEREIN; NEITHER DOES IT CONVEY ANY LICENSE UNDER ITS PATENT RIGHTS, NOR THE RIGHTS OF OTHERS.

APEC RESERVES THE RIGHT TO MAKE CHANGES WITHOUT FURTHER NOTICE TO ANY PRODUCTS HEREIN TO IMPROVE RELIABILITY, FUNCTION OR DESIGN.



Typical Electrical Characteristics

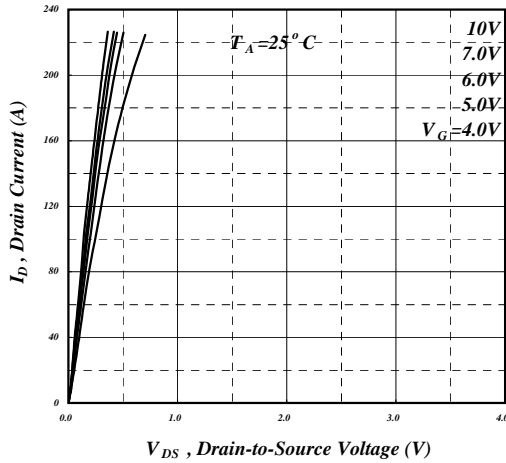

Fig 1. Typical Output Characteristics

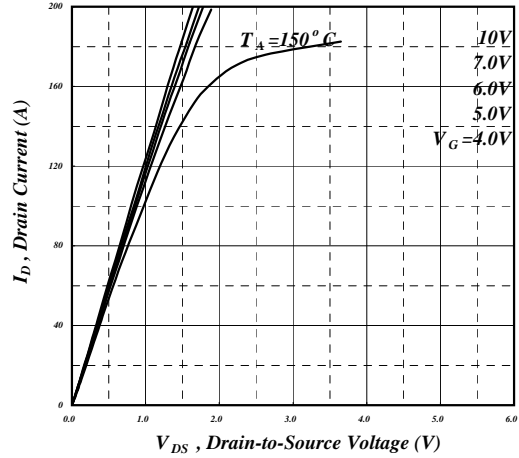

Fig 2. Typical Output Characteristics

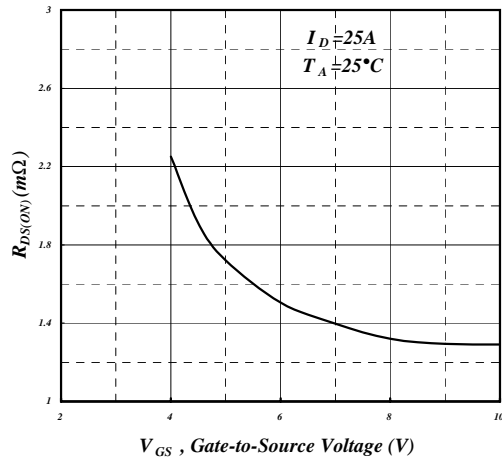

Fig 3. On-Resistance vs. Gate Voltage

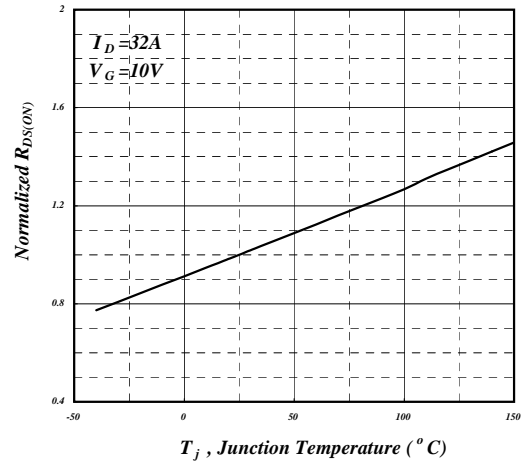

Fig 4. Normalized On-Resistance vs. Junction Temperature

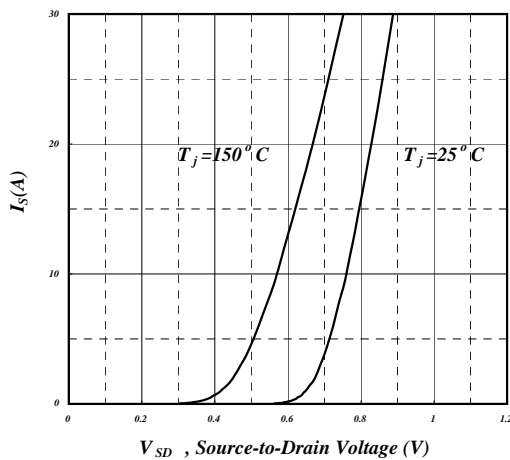

Fig 5. Forward Characteristic of Reverse Diode

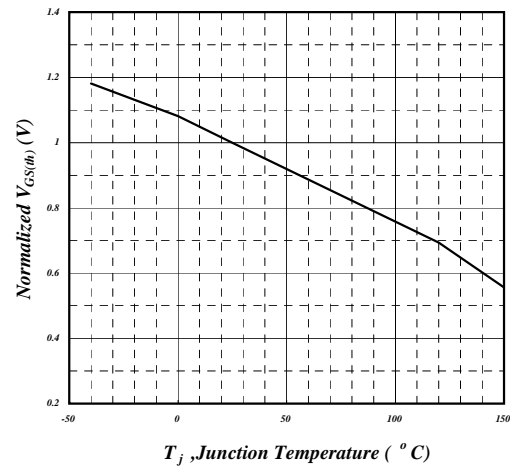

Fig 6. Gate Threshold Voltage vs. Junction Temperature



Typical Electrical Characteristics (cont.)

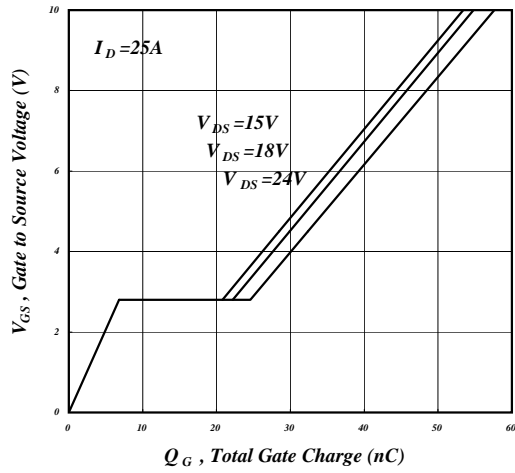

Fig 7. Gate Charge Characteristics

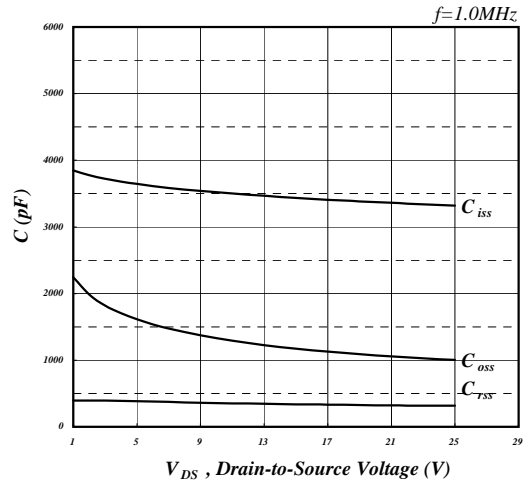

Fig 8. Typical Capacitance Characteristics

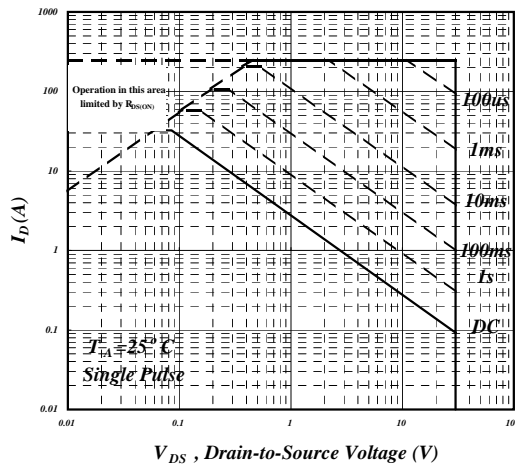

Fig 9. Maximum Safe Operating Area

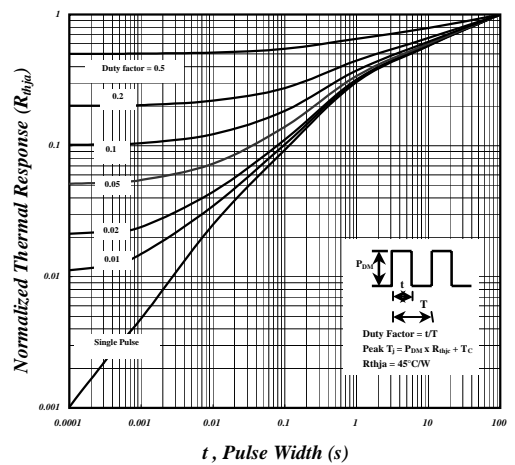

Fig 10. Effective Transient Thermal Impedance

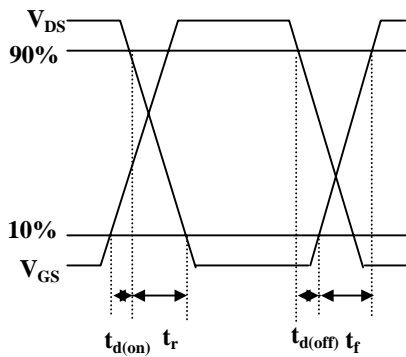

Fig 11. Switching Time Waveform

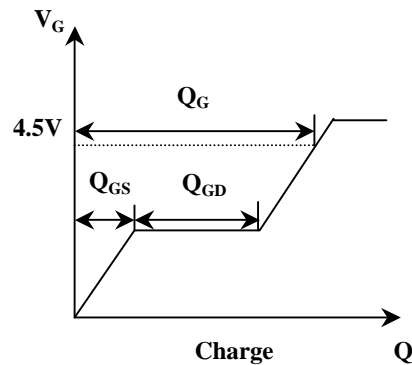
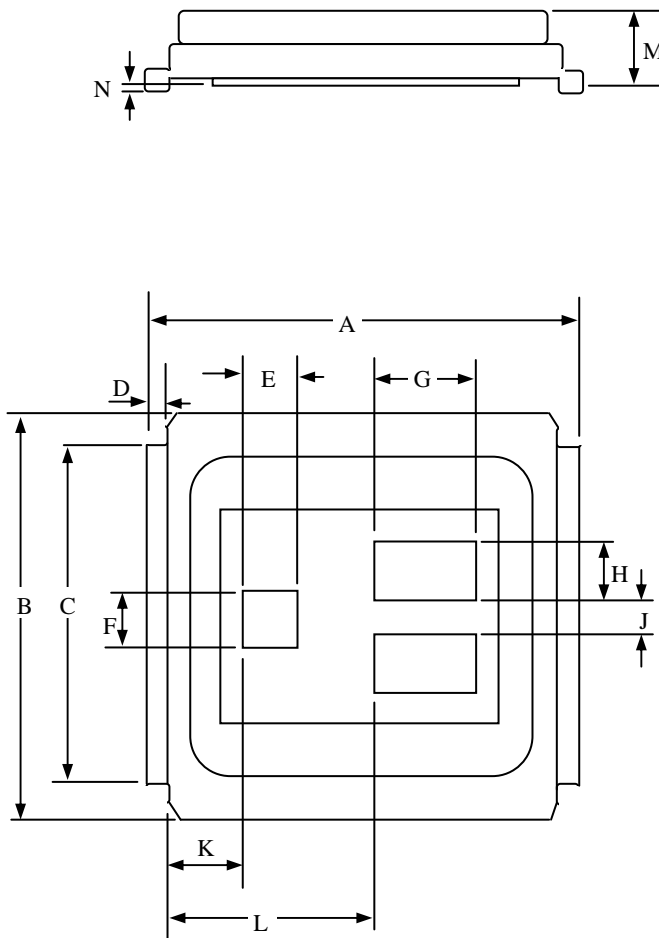

Fig 12. Gate Charge Waveform



Package Dimensions: Medium Size Can MX



| SYMBOLS | Millimeters |      |      |
|---------|-------------|------|------|
|         | MIN         | NOM  | MAX  |
| A       | 6.25        | 6.30 | 6.35 |
| B       | 4.80        | 4.93 | 5.05 |
| C       | 3.85        | 3.90 | 3.95 |
| D       | 0.35        | 0.40 | 0.45 |
| E       | 0.68        | 0.70 | 0.72 |
| F       | 0.68        | 0.70 | 0.72 |
| G       | 1.38        | 1.40 | 1.42 |
| H       | 0.80        | 0.82 | 0.84 |
| J       | 0.38        | 0.40 | 0.42 |
| K       | 0.88        | 0.95 | 1.01 |
| L       | 2.28        | 2.35 | 2.41 |
| M       | 0.59        | 0.65 | 0.70 |
| N       | 0.03        | 0.06 | 0.08 |

1. All dimensions are in millimeters.
2. For information on solder stencil and substrate design, please contact APEC at support@a-powerusa.com

Marking Information:

Laser Marking

