



AP1152ADUXX

14.5V Input / 300mA Output LDO Regulator

1. General Description

The AP1152ADUxx is a low dropout linear regulator with ON/OFF control, which can supply 300mA load current. The IC is an integrated circuit with a silicon monolithic bipolar structure. The output voltage, trimmed with high accuracy, is available from 1.3 to 9.5V in 0.1V steps. The output capacitor is available to use a small 0.1uF ceramic capacitor ($2.5V \leq V_{out}$). The over current, thermal and reverse bias protections are integrated, and also the package is small and high power dissipation type. The IC is designed for space saving requirements.

2. Feature

- Available to use a small 0.1uF ceramic capacitor
- Dropout Voltage 105mV at 100mA
- Output Current 300mA Peak 480mA
- High Precision output voltage $\pm 1.5\%$ or $\pm 50mV$
- High ripple rejection ratio 80dB at 1kHz
- Wide operating voltage range 2.1V to 14.5V
- Very low quiescent current $65\mu A$ at $I_{OUT}=0mA$
- On/Off control (High active)
- Built-in Short circuit protection, thermal shutdown
- Built-in reverse bias over current protection
- Available very low noise application
- Very small surface mount package SOT89-5

3. Application

- Any Electronic Equipment
- Battery Powered Systems
- Mobile Communication

4. Table of Contents

1. General Description	1
2. Feature.....	1
3. Application.....	1
4. Table of Contents.....	2
5. Block Diagram	3
6. Ordering Information	4
7. Pin Configurations	5
■ Pin Configurations.....	5
■ Functions	5
8. Absolute Maximum Ratings	6
9. Recommended Operating Conditions	6
10. Electrical Characteristics.....	7
■ Electrical Characteristics of Ta=Tj=25°C	7
■ Electrical Characteristics of Ta=-40°C~85°C.....	10
11. Description	13
11.1 Input / output capacitors	13
11.2 Output noise	14
11.3 Ripple Rejection	15
11.4 DC Characteristics.....	16
11.5 Temperature Characteristics	18
11.6 On/Off Control	20
11.7 PCB Layout	21
12. Definition of term.....	22
13. Recommended External Circuits.....	23
■ External Circuit	23
14. Package	24
■ Outline Dimensions	24
15. Revise History	25
IMPORTANT NOTICE.....	26

5. Block Diagram

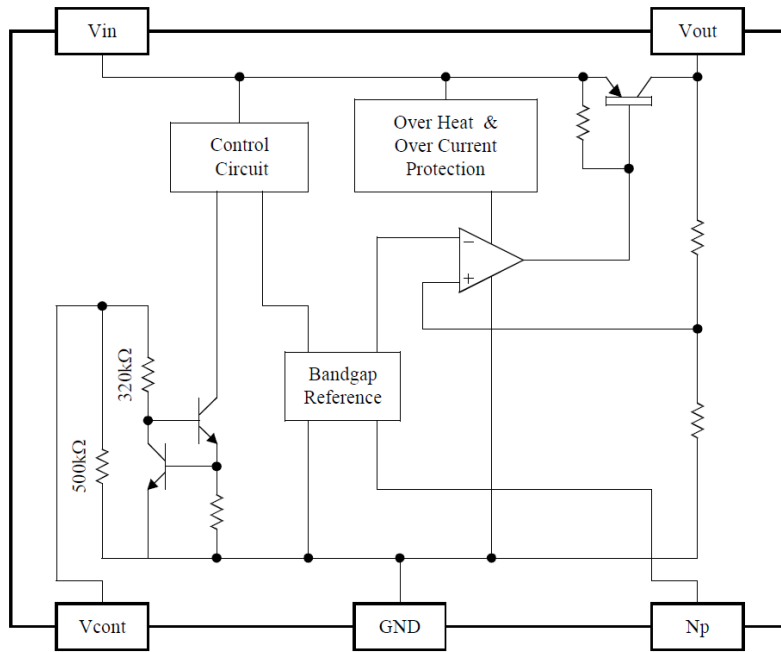

Figure 1. Block Diagram

6. Ordering Information

AP1152ADUXX -40 to 85°C SOT89-5

• Output Voltage Code

For product name, please check the below chart. Please contact your authorized ASAHI KASEI MICRODEVICES representative for voltage availability.

AP1152ADUXX
└─── Output voltage code

Table 1. Standard Voltage Version, Output Voltage & Voltage Code

XX	V _{OUT}	XX	V _{OUT}	XX	V _{OUT}
18	1.8	30	3.0	45	4.5
25	2.5	33	3.3	50	5.0
28	2.8	40	4.0	-	-

Table 2. Optional Voltage Version, Output Voltage & Voltage Code

XX	V _{OUT}	XX	V _{OUT}	XX	V _{OUT}	XX	V _{OUT}
13	1.3	26	2.6	41	4.1	54	5.4
14	1.4	27	2.7	42	4.2	5E	5.45
15	1.5	29	2.9	43	4.3	55	5.5
16	1.6	31	3.1	44	4.4	60	6.0
17	1.7	32	3.2	46	4.6	65	6.5
19	1.9	34	3.4	47	4.7	70	7.0
20	2.0	35	3.5	48	4.8	75	7.5
21	2.1	36	3.6	49	4.9	80	8.0
22	2.2	37	3.7	51	5.1	85	8.5
23	2.3	38	3.8	52	5.2	90	9.0
24	2.4	39	3.9	53	5.3	95	9.5

7. Pin Configurations

■ Pin Configurations

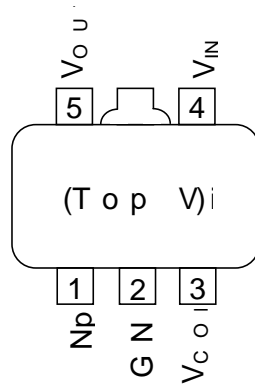

■ Functions

Pin No.	Pin Description	Internal Equivalent Circuit	Description
1	Np		<p>Noise Bypass Terminal</p> <p>Connect a bypass capacitor between GND.</p>
2	GND		GND Terminal
3	V _{CONT}		<p>On/Off Control Terminal</p> <p>The pull-down resistor (500kΩ) is built-in.</p>
4	V _{IN}		Input Terminal
5	V _{OUT}		Output Terminal

8. Absolute Maximum Ratings

Parameter	Symbol	min	max	Unit	Condition
Supply Voltage	$V_{CC_{MAX}}$	-0.4	16	V	
Reverse Bias	$V_{rev_{MAX}}$	-0.4	6	V	$V_{out} \leq 2.0V$
		-0.4	12	V	$2.1V \leq V_{out}$
Np Terminal Voltage	$V_{np_{MAX}}$	-0.4	5	V	
Vcont Terminal Voltage	$V_{cont_{MAX}}$	-0.4	16	V	
Junction Temperature	T_j	-	150	°C	
Storage Temperature Range	T_{stg}	-55	150	°C	
Power Dissipation	P_D	-	900	mW	(Note 1)

Note 1. Please do derating with $7.2mW/°C$ at $P_d=900mW$ and $25°C$ or more. Thermal resistance (θ_{JA}) = $138°C/W$.

WARNING: The maximum ratings are the absolute limitation values with the possibility of the IC breakage. When the operation exceeds this standard quality cannot be guaranteed.

9. Recommended Operating Conditions

Parameter	Symbol	min	typ	max	Unit	Condition
Operating Temperature Range	T_a	-40	-	85	°C	
Operating Voltage Range	V_{OP}	2.1	-	14.5	V	

10. Electrical Characteristics

■ Electrical Characteristics of Ta=Tj=25°C

The parameters with min or max values will be guaranteed at Ta=Tj=25°C.

(V_{IN}=V_{out}(typ)+1V, V_{cont}=1.8V, Ta=Tj=25°C)

Parameter	Symbol	Condition	min	typ	max	Unit
Output Voltage	V _{out}	I _{out} = 5mA	(Table 3, Table 4)			V
Line Regulation	LinReg	ΔV _{IN} = 5V	-	0.0	6.0	mV
Load Regulation	LoaReg	I _{out} = 5mA ~ 100mA	(Table 3, Table 4)			mV
		I _{out} = 5mA ~ 200mA				
		I _{out} = 5mA ~ 300mA				
Dropout Voltage (Note 2)	V _{drop}	I _{out} = 100mA	-	105	170	mV
		I _{out} = 200mA	-	170	270	
		I _{out} = 270mA (2.1V ≤ V _{out} ≤ 2.3V)	-	235	370	
		I _{out} = 300mA (2.4V ≤ V _{out})	-	235	370	
Maximum Output Current (Note 3)	I _{out} MAX	V _{out} =V _{out} (typ)×0.9	380	480	-	mA
Short Circuit Current (Note 3)	I _{SHORT}		-	500	-	mA
Quiescent Current	I _q	I _{out} = 0mA	-	65	90	μA
Standby Current	I _{standby}	V _{cont} = 0V	-	0.0	0.1	μA
Ground Terminal Current	I _{gnd}	I _{out} = 100mA	-	1.8	3.0	mA
V _{cont} Terminal						
V _{cont} Terminal Current	I _{cont}	V _{cont} = 1.8V	-	5.0	10.0	μA
V _{cont} Terminal Voltage	V _{cont}	V _{out} ON state	1.8	-	-	V
		V _{out} OFF state	-	-	0.35	V

Note 2. For V_{out} ≤ 2.0V, no regulations.

Note 3. The maximum output current is limited by power dissipation.

Table 3. Standard Voltage Version

Part Number	Output Voltage			Load Regulation					
				Iout = 100mA		Iout = 200mA		Iout = 300mA	
	min	typ	max	typ	max	typ	max	typ	max
V	V	V	mV	mV	mV	mV	mV	mV	mV
AP1152ADU18	1.750	1.800	1.850	11	25	23	51	36	83
AP1152ADU25	2.450	2.500	2.550	12	27	24	55	40	91
AP1152ADU28	2.750	2.800	2.850	12	27	25	57	41	95
AP1152ADU30	2.950	3.000	3.050	12	28	26	58	42	97
AP1152ADU33	3.250	3.300	3.350	13	28	26	60	44	101
AP1152ADU40	3.940	4.000	4.060	13	30	28	64	48	109
AP1152ADU45	4.432	4.500	4.568	14	31	29	67	50	115
AP1152ADU50	4.925	5.000	5.075	14	32	31	70	53	121

Table 4. Optional Voltage Version

Part Number	Output Voltage			Load Regulation					
				Iout = 100mA		Iout = 200mA		Iout = 300mA	
	min	typ	max	typ	max	typ	max	typ	max
	V	V	V	mV	mV	mV	mV	mV	mV
AP1152ADU13	1.250	1.300	1.350	11	24	21	49	34	77
AP1152ADU14	1.350	1.400	1.450	11	24	22	49	34	78
AP1152ADU15	1.450	1.500	1.550	11	24	22	50	35	79
AP1152ADU16	1.550	1.600	1.650	11	24	22	50	35	80
AP1152ADU17	1.650	1.700	1.750	11	25	22	51	36	82
AP1152ADU19	1.850	1.900	1.950	11	25	23	52	37	84
AP1152ADU20	1.950	2.000	2.050	11	25	23	53	37	85
AP1152ADU21	2.050	2.100	2.150	11	26	23	53	38	86
AP1152ADU22	2.150	2.200	2.250	12	26	24	54	38	88
AP1152ADU23	2.250	2.300	2.350	12	26	24	54	39	89
AP1152ADU24	2.350	2.400	2.450	12	26	24	55	39	90
AP1152ADU26	2.550	2.600	2.650	12	27	25	56	40	92
AP1152ADU27	2.650	2.700	2.750	12	27	25	56	41	93
AP1152ADU29	2.850	2.900	2.950	12	27	25	58	42	96
AP1152ADU31	3.050	3.100	3.150	12	28	26	59	43	98
AP1152ADU32	3.150	3.200	3.250	12	28	26	59	44	99
AP1152ADU34	3.349	3.400	3.451	13	29	27	60	45	102
AP1152ADU35	3.447	3.500	3.553	13	29	27	61	45	103
AP1152ADU36	3.546	3.600	3.654	13	29	27	62	46	104
AP1152ADU37	3.644	3.700	3.756	13	29	27	62	46	105
AP1152ADU38	3.743	3.800	3.857	13	29	28	63	47	107
AP1152ADU39	3.841	3.900	3.959	13	30	28	63	47	108
AP1152ADU41	4.038	4.100	4.162	13	30	28	64	48	110
AP1152ADU42	4.137	4.200	4.263	13	30	29	65	49	111
AP1152ADU43	4.235	4.300	4.365	14	31	29	66	49	112
AP1152ADU44	4.334	4.400	4.466	14	31	29	66	50	114
AP1152ADU46	4.531	4.600	4.669	14	31	30	67	51	116
AP1152ADU47	4.629	4.700	4.771	14	31	30	68	51	117
AP1152ADU48	4.728	4.800	4.872	14	32	30	68	52	118
AP1152ADU49	4.826	4.900	4.974	14	32	30	69	52	120
AP1152ADU51	5.023	5.100	5.177	14	32	31	70	53	122
AP1152ADU52	5.122	5.200	5.278	14	33	31	71	54	123
AP1152ADU53	5.220	5.300	5.380	15	33	31	71	54	124
AP1152ADU54	5.319	5.400	5.481	15	33	32	72	55	125
AP1152ADU5E	5.368	5.450	5.532	15	33	32	72	55	127
AP1152ADU55	5.417	5.500	5.583	15	33	32	72	55	127
AP1152ADU60	5.910	6.000	6.090	15	34	33	75	58	133
AP1152ADU65	6.402	6.500	6.598	16	36	34	78	61	139
AP1152ADU70	6.895	7.000	7.105	16	37	35	81	63	144
AP1152ADU75	7.387	7.500	7.613	17	38	37	84	66	150
AP1152ADU80	7.880	8.000	8.120	17	39	38	87	68	156
AP1152ADU85	8.372	8.500	8.628	18	40	39	89	71	162
AP1152ADU90	8.865	9.000	9.135	18	41	40	92	73	168
AP1152ADU95	9.357	9.500	9.643	19	42	42	95	76	174

■ Electrical Characteristics of Ta=-40°C~85°C

The parameters with min or max values will be guaranteed at Ta=-40 ~ 85°C.

(V_{IN}=V_{out}(typ)+1V, V_{cont}=1.8V, Ta=-40~85°C)

Parameter	Symbol	Condition	min	typ	max	Unit
Output Voltage	V _{out}	I _{out} = 5mA	(Table 5, Table 6)			V
Line Regulation	LinReg	ΔV _{IN} = 5V	-	0.0	8.0	mV
Load Regulation	LoaReg	I _{out} = 5mA ~ 100mA	(Table 5, Table 6)			mV
		I _{out} = 5mA ~ 200mA				
		I _{out} = 5mA ~ 300mA				
Dropout Voltage (Note 4)	V _{drop}	I _{out} = 100mA (2.2V ≤ V _{out})	-	105	200	mV
		I _{out} = 200mA (2.2V ≤ V _{out})	-	170	320	
		I _{out} = 300mA (2.4V ≤ V _{out})	-	235	440	
Maximum Output Current (Note 5)	I _{out} MAX	V _{out} =V _{out} (typ)×0.9	340	480	-	mA
Short Circuit Current (Note 5)	I _{SHORT}		-	500	-	mA
Quiescent Current	I _q	I _{out} = 0mA	-	65	100	μA
Standby Current	I _{standby}	V _{cont} = 0V	-	0.0	0.5	μA
Ground Terminal Current	I _{gnd}	I _{out} = 100mA	-	1.8	3.6	mA
V _{cont} Terminal						
V _{cont} Terminal Current	I _{cont}	V _{cont} = 1.8V	-	5.0	12.0	μA
V _{cont} Terminal Voltage	V _{cont}	V _{out} ON state	1.8	-	-	V
		V _{out} OFF state	-	-	0.35	V

Note 4. For V_{out} ≤ 2.1V, no regulations.

Note 5. The maximum output current is limited by power dissipation.

Table 5. Standard Voltage Version

Part Number	Output Voltage			Load Regulation					
				Iout = 100mA		Iout = 200mA		Iout = 300mA	
	min	typ	max	typ	max	typ	max	typ	max
	V	V	V	mV	mV	mV	mV	mV	mV
AP1152ADU18	1.720	1.800	1.880	11	30	23	63	36	118
AP1152ADU25	2.420	2.500	2.580	12	31	24	68	40	131
AP1152ADU28	2.720	2.800	2.880	12	32	25	70	41	137
AP1152ADU30	2.920	3.000	3.080	12	33	26	72	42	141
AP1152ADU33	3.217	3.300	3.383	13	33	26	74	44	147
AP1152ADU40	3.900	4.000	4.100	13	35	28	79	48	161
AP1152ADU45	4.387	4.500	4.613	14	36	29	82	50	170
AP1152ADU50	4.875	5.000	5.125	14	37	31	86	53	180

Table 6. Optional Voltage Version

Part Number	Output Voltage			Load Regulation					
				Iout = 100mA		Iout = 200mA		Iout = 300mA	
	min	typ	max	typ	max	typ	max	typ	max
V	V	V	mV	mV	mV	mV	mV	mV	mV
AP1152ADU13	1.220	1.300	1.380	11	29	21	60	34	95
AP1152ADU14	1.320	1.400	1.480	11	29	22	61	34	96
AP1152ADU15	1.420	1.500	1.580	11	29	22	61	35	97
AP1152ADU16	1.520	1.600	1.680	11	29	22	62	35	98
AP1152ADU17	1.620	1.700	1.780	11	30	22	63	36	100
AP1152ADU19	1.820	1.900	1.980	11	30	23	64	37	120
AP1152ADU20	1.920	2.000	2.080	11	30	23	65	37	122
AP1152ADU21	2.020	2.100	2.180	11	31	23	65	38	124
AP1152ADU22	2.120	2.200	2.280	12	31	24	66	38	126
AP1152ADU23	2.220	2.300	2.380	12	31	24	67	39	127
AP1152ADU24	2.320	2.400	2.480	12	31	24	68	39	129
AP1152ADU26	2.520	2.600	2.680	12	32	25	69	40	133
AP1152ADU27	2.620	2.700	2.780	12	32	25	70	41	135
AP1152ADU29	2.820	2.900	2.980	12	32	25	71	42	139
AP1152ADU31	3.020	3.100	3.180	12	33	26	73	43	143
AP1152ADU32	3.120	3.200	3.280	12	33	26	73	44	145
AP1152ADU34	3.315	3.400	3.485	13	33	27	75	45	149
AP1152ADU35	3.412	3.500	3.588	13	34	27	75	45	151
AP1152ADU36	3.510	3.600	3.690	13	34	27	76	46	153
AP1152ADU37	3.607	3.700	3.793	13	34	27	77	46	155
AP1152ADU38	3.705	3.800	3.895	13	34	28	77	47	157
AP1152ADU39	3.802	3.900	3.998	13	34	28	78	47	159
AP1152ADU41	3.997	4.100	4.203	13	35	28	80	48	162
AP1152ADU42	4.095	4.200	4.305	13	35	29	80	49	164
AP1152ADU43	4.192	4.300	4.408	14	35	29	81	49	166
AP1152ADU44	4.290	4.400	4.510	14	36	29	82	50	168
AP1152ADU46	4.485	4.600	4.715	14	36	30	83	51	172
AP1152ADU47	4.582	4.700	4.818	14	36	30	84	51	174
AP1152ADU48	4.680	4.800	4.920	14	36	30	84	52	176
AP1152ADU49	4.777	4.900	5.023	14	37	30	85	52	178
AP1152ADU51	4.972	5.100	5.228	14	37	31	87	53	182
AP1152ADU52	5.070	5.200	5.330	14	37	31	87	54	184
AP1152ADU53	5.167	5.300	5.433	15	38	31	88	54	186
AP1152ADU54	5.265	5.400	5.535	15	38	32	89	55	188
AP1152ADU5E	5.313	5.450	5.587	15	38	32	89	55	190
AP1152ADU55	5.362	5.500	5.638	15	38	32	89	55	190
AP1152ADU60	5.850	6.000	6.150	15	39	33	93	58	199
AP1152ADU65	6.337	6.500	6.663	16	40	34	96	61	209
AP1152ADU70	6.825	7.000	7.175	16	41	35	100	63	219
AP1152ADU75	7.312	7.500	7.688	17	42	37	103	66	229
AP1152ADU80	7.800	8.000	8.200	17	43	38	107	68	238
AP1152ADU85	8.287	8.500	8.713	18	45	39	110	71	248
AP1152ADU90	8.775	9.000	9.225	18	46	40	114	73	258
AP1152ADU95	9.262	9.500	9.738	19	47	42	117	76	267

11. Description

11.1 Input / output capacitors

Linear regulators require input and output capacitors in order to maintain the regulator's loop stability. If a 0.1μF capacitor is connected to the output side, the IC provides stable operation at any voltage in the practical current region. However, increase the CL capacitance when using the IC in the low current region and low voltage. Otherwise, the IC oscillates. The equivalent series resistance (ESR) of the output capacitor must be in the stable operation area. However, it is recommended to use as large a value of capacitance as is practical. The output noise and the ripple noise decrease as the capacitance value increases. ESR values vary widely between ceramic and tantalum capacitors. However, tantalum capacitors are assumed to provide more ESR damping resistance, which provides greater circuit stability. This implies that a higher level of circuit stability can be obtained by using tantalum capacitors when compared to ceramic capacitors with similar values.

The recommended value : $C_{in}=C_L=0.22\mu F(MLCC)$ $I_{out} \geq 0.5mA$.

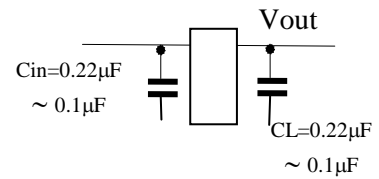

The input capacitor is necessary when the battery is discharged, the power supply impedance increases, or the line distance to the power supply is long.

This capacitor might be necessary on each individual IC even if two or more regulator ICs are used. Please confirm the stability while mounted. The IC provides stable operation with an output side capacitor of 0.1μF ($V_{out} \geq 2.5V$). If it is 0.1μF or more over the full range of temperature, either a ceramic capacitor or tantalum capacitor can be used without considering ESR. Please confirm stability while mounted.

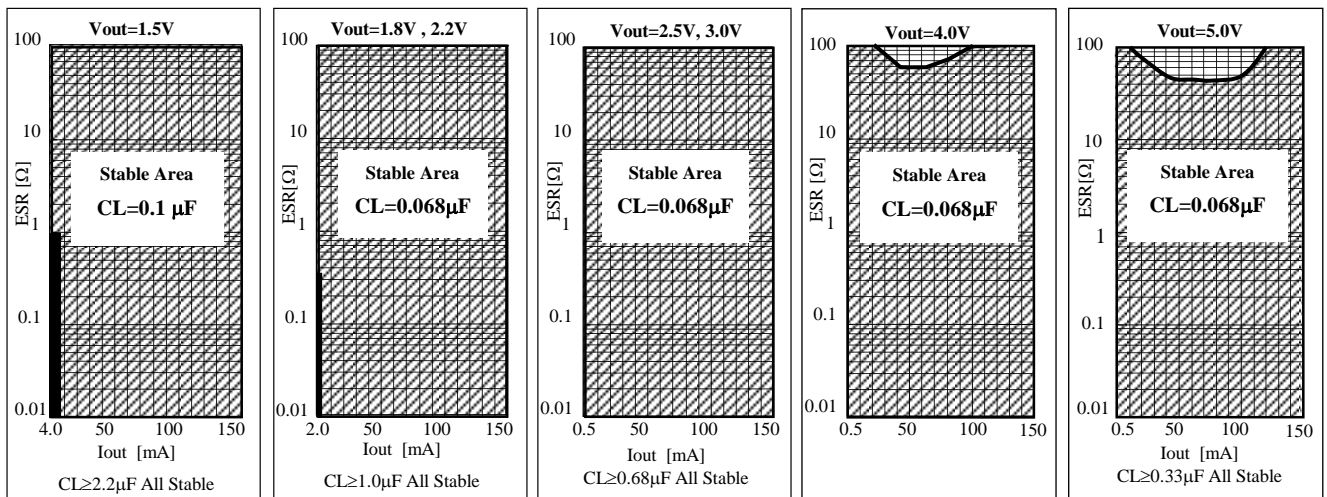
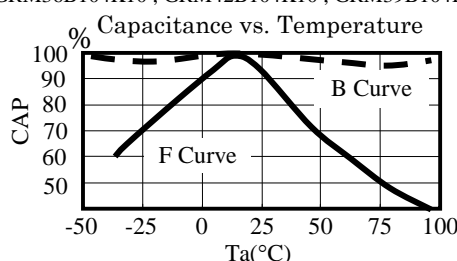
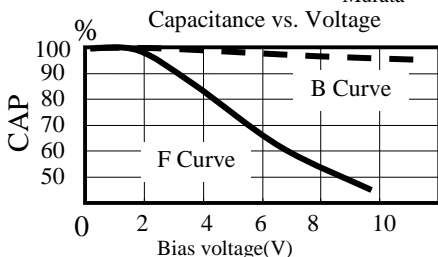

Figure 2. Output voltage, Output current vs. Stable Operation Area

The above graphs show stable operation with a ceramic capacitor of 0.1μF (excluding the low current region). If the capacitance is not increased in the low voltage, low current area, stable operation may not be achieved. Please select the best output capacitor according to the voltage and current used. The stability of the regulator improves if a big output side capacitor is used (the stable operation area extends.) Please use as large a capacitance as is practical. Although operation above 150 mA has not been described, stability is equal to or better than operation at 150 mA.

For evaluation Kyocera :CM05B104K10AB , CM05B224K10AB , CM105B104K16A , CM105B224K16A , CM21B225K10A
 Murata :GRM36B104K10 , GRM42B104K10 , GRM39B104K25 , GRM39B224K10 , GRM39B105K6.3



Generally, a ceramic capacitor has both a temperature characteristic and a voltage characteristic. Please consider both characteristics when selecting the part. The B curves are the recommend characteristics.

11.2 Output noise

AP1152ADU30 Cnp vs. Noise Iout=30mA BPF=400Hz ~ 80kHz

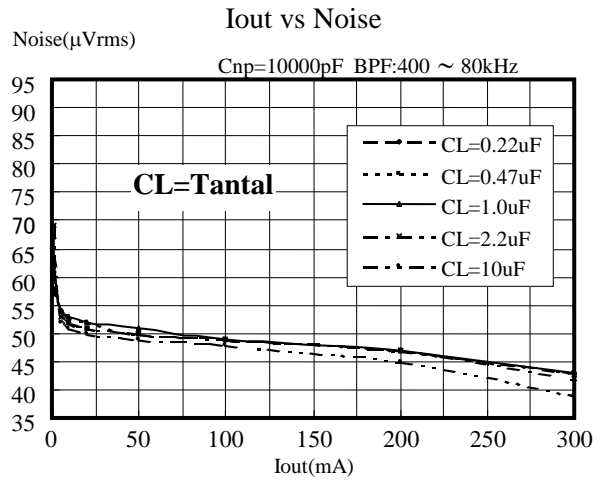
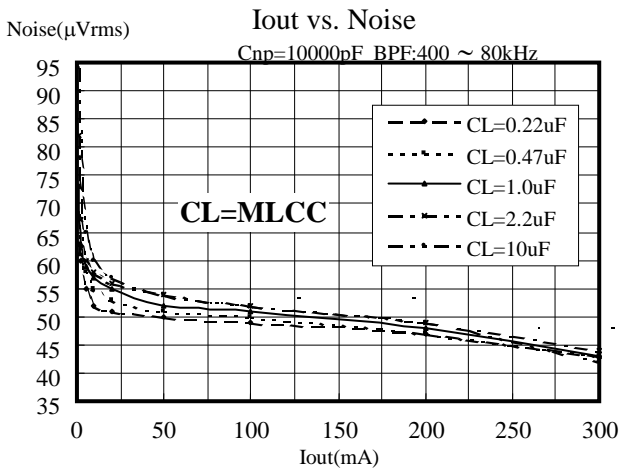
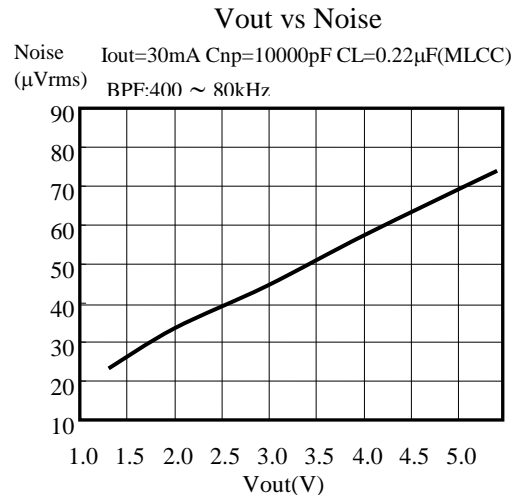
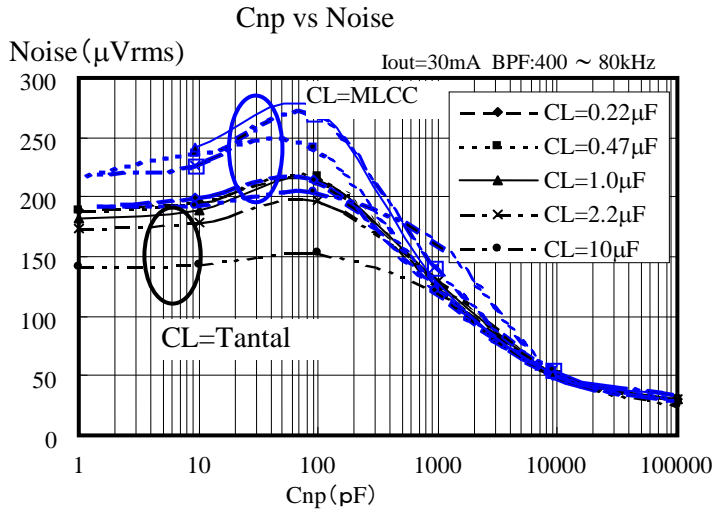

Increase Cnp to decrease the noise. The recommended Cnp capacitance is 6800pF(682) ~ 0.22µF(224). The amount of noise increases with the higher output voltages.

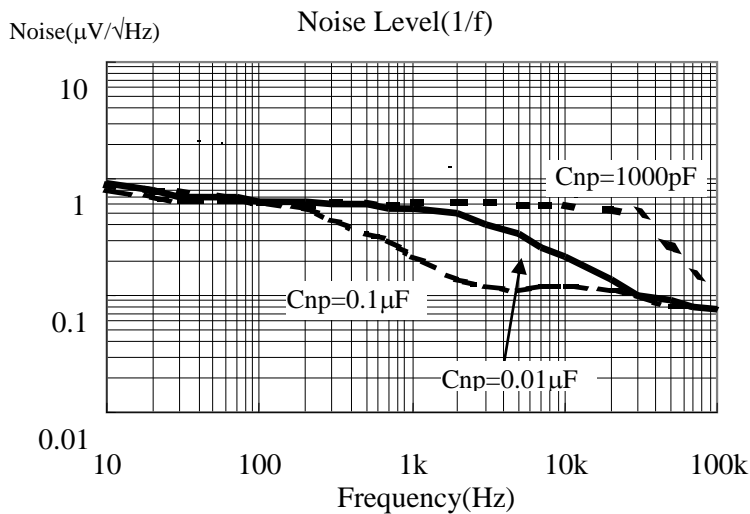

Cin=10µF Iout=10mA
CL=0.22µF (Ceramic)

11.3 Ripple Rejection

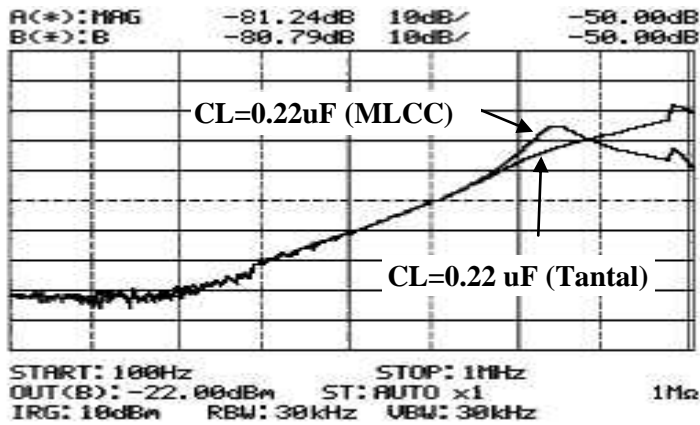

$V_{IN}=5.0V$ $V_{out}=3.0V$ $I_{out}=10mA$
 $V_R=500mV_{p-p}$ $f=100 \sim 1MHz$ $C_{np}=0.1\mu F$

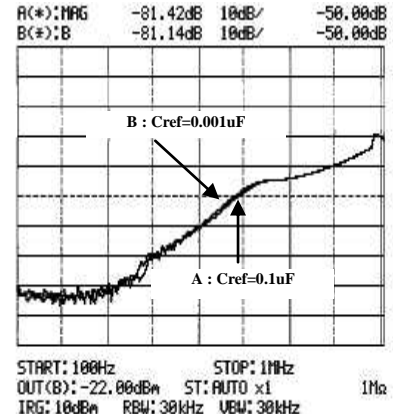
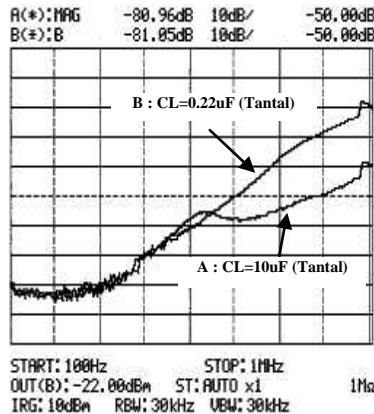
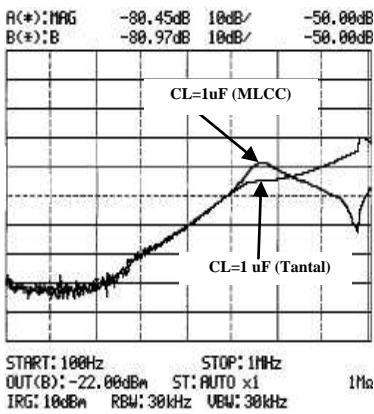
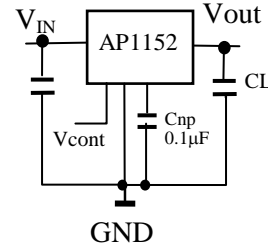

The ripple rejection characteristic depends on the characteristic and the capacitance value of the capacitor connected to the output side. The RR characteristic of 50KHz or more varies greatly with the capacitor on the output side and PCB pattern. If necessary, please confirm stability while operating.

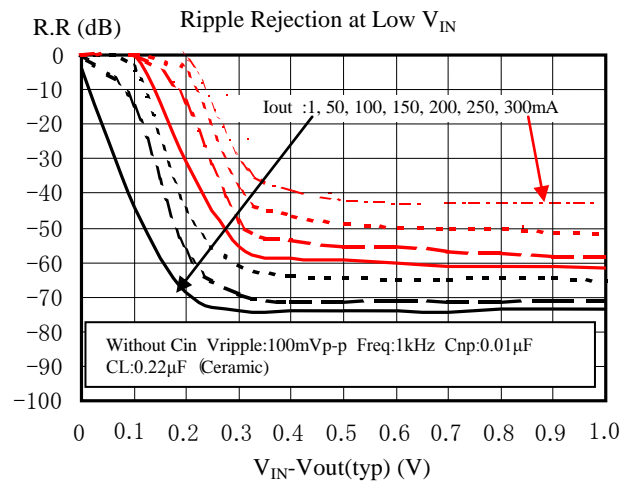
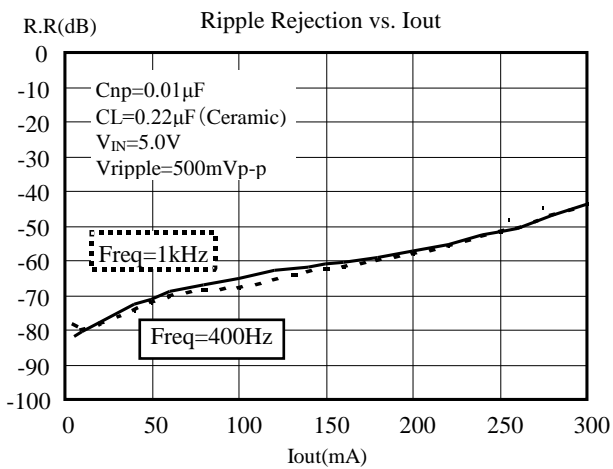

11.4 DC Characteristics

$\Delta V_{out}(mV)$ Line regulation

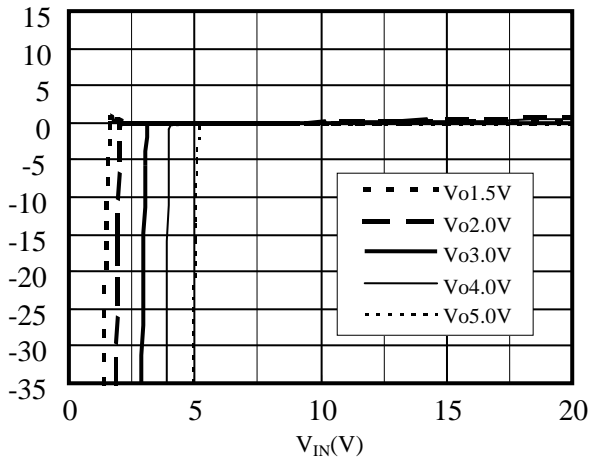

$\Delta V_{out}(mV)$ Load regulation

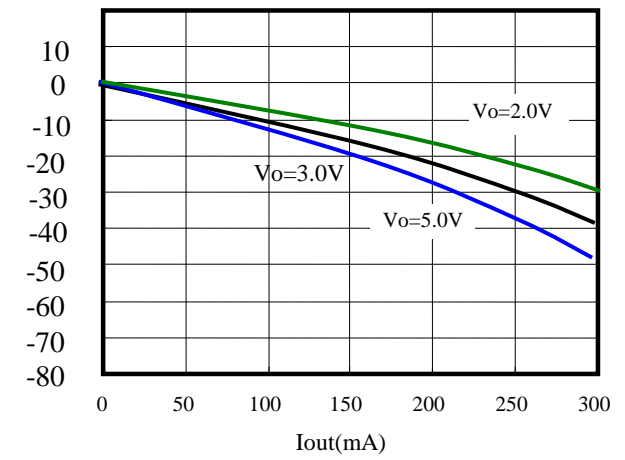

$\Delta V_{out}(mV)$ Regulation point

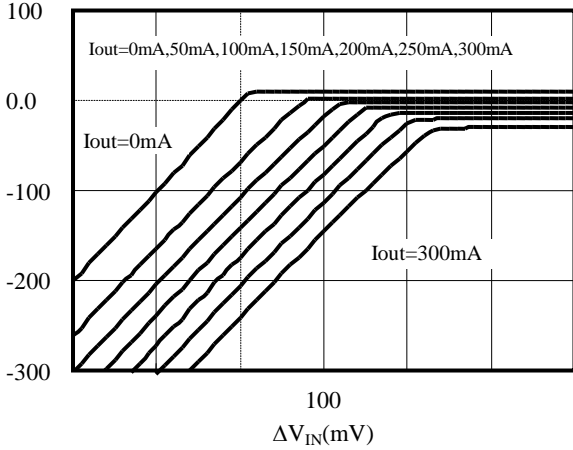

$V_{drop}(mV)$ V_{drop}

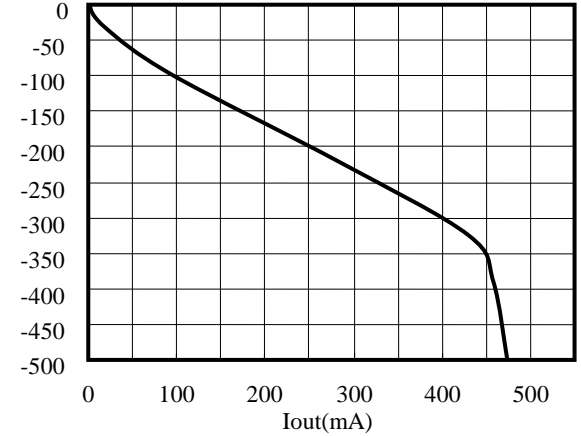

$I_{cont}(\mu A)$ V_{cont} vs. I_{cont}

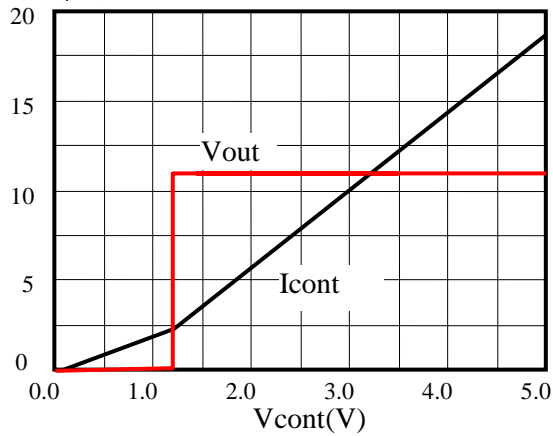

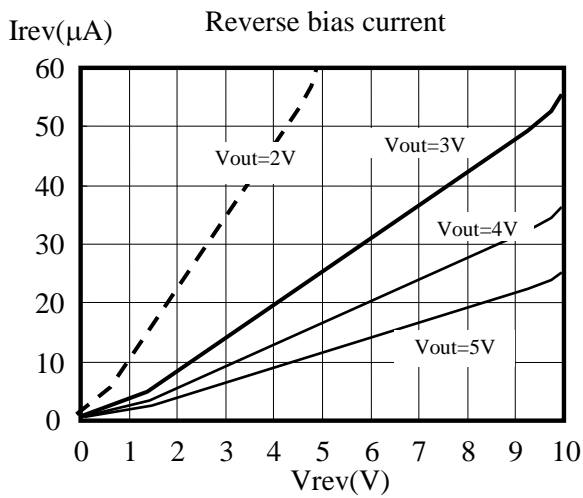
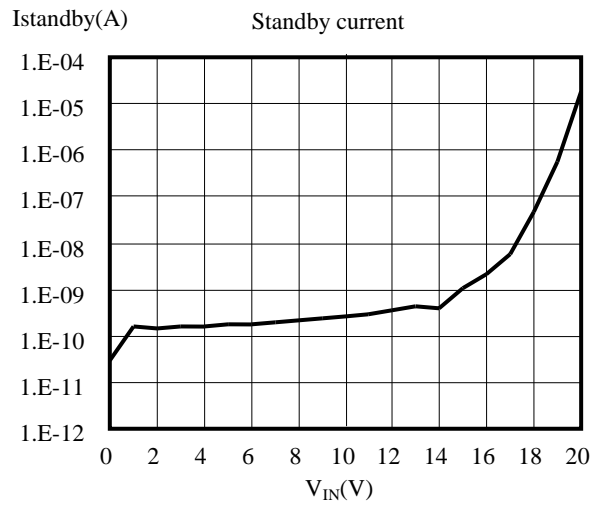
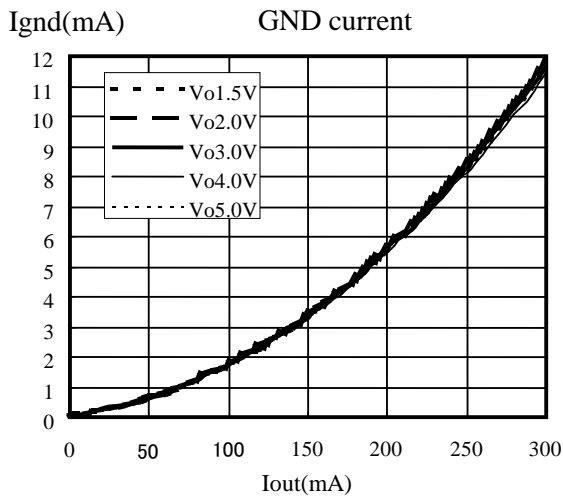
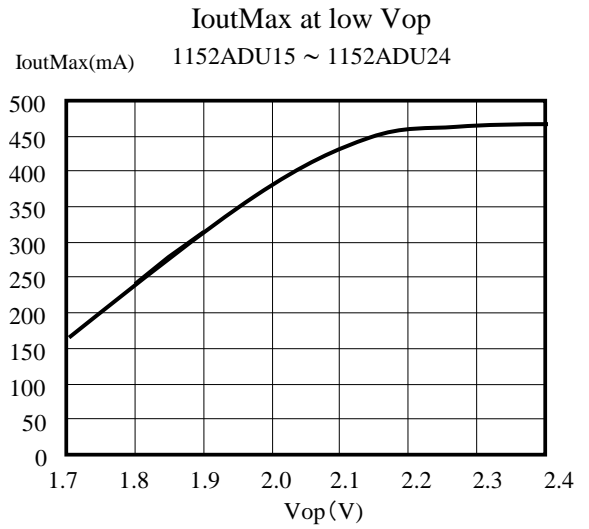
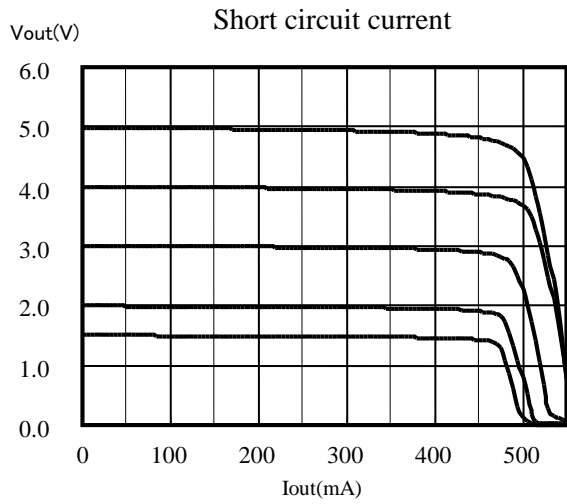

11.5 Temperature Characteristics

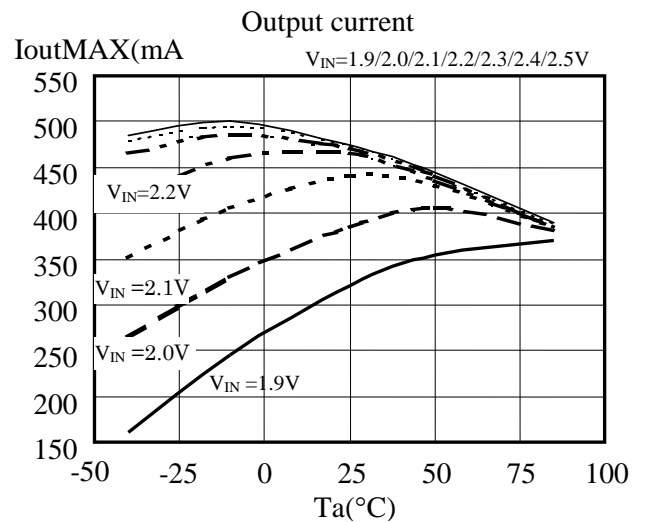
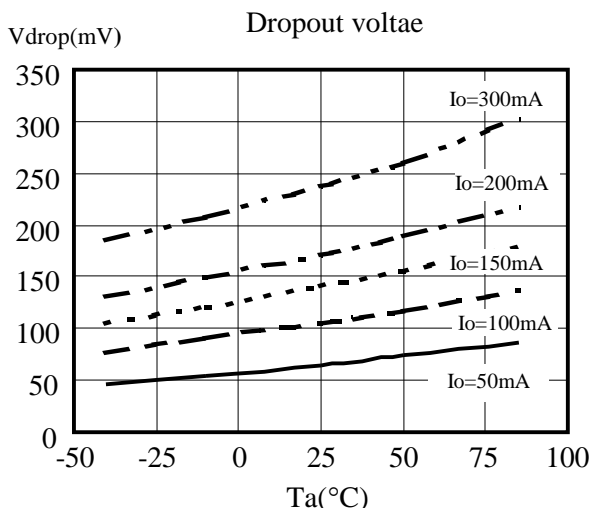
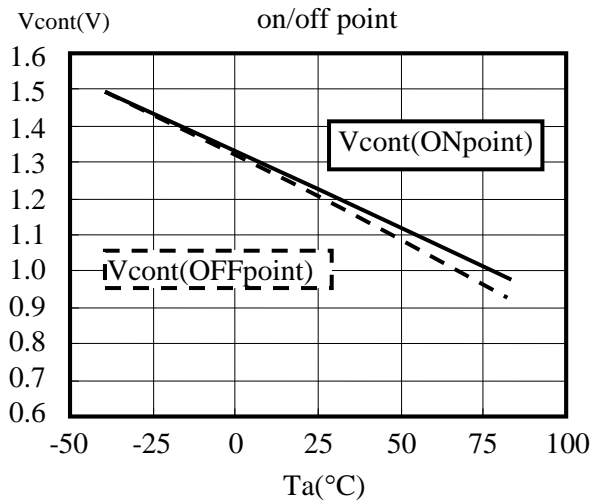
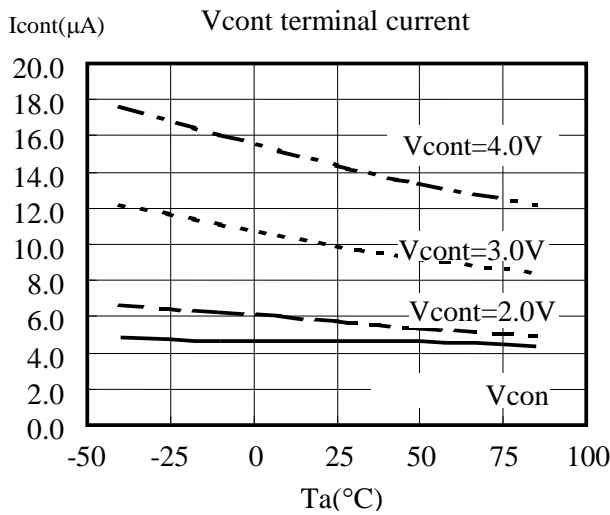
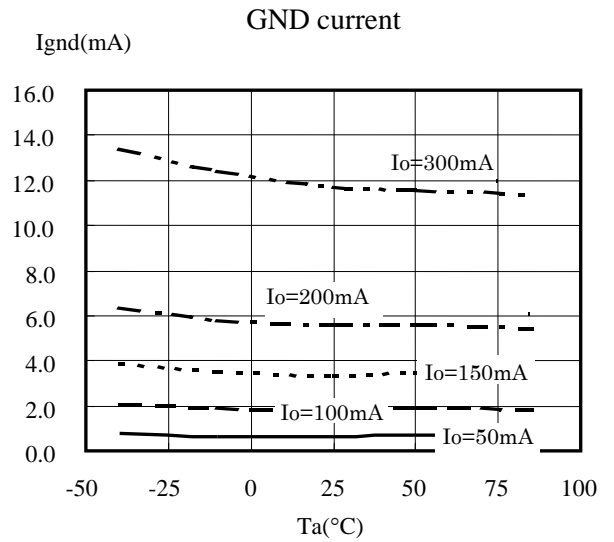
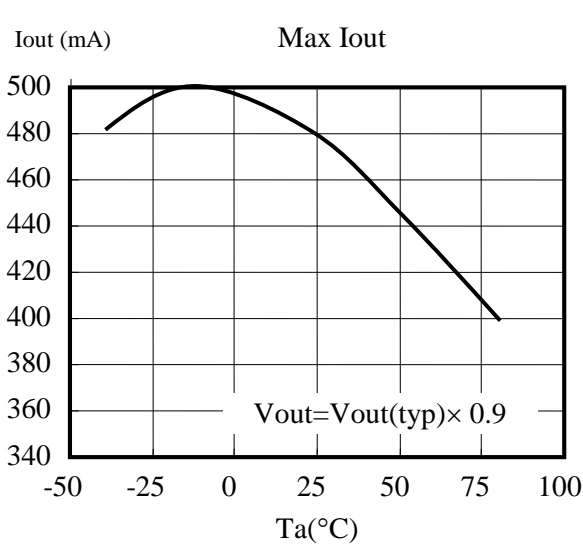

• Output voltage vs. Temperature characteristics

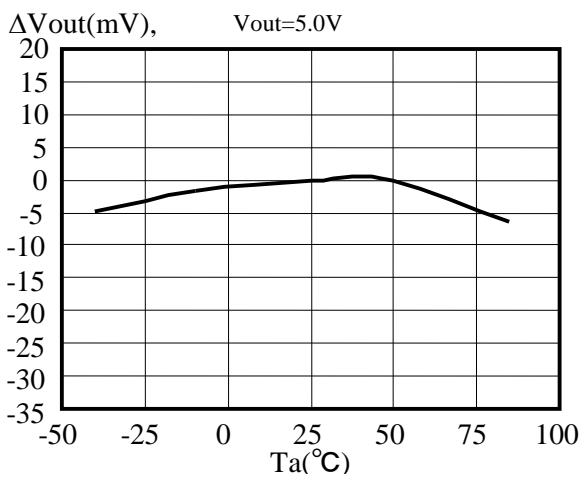
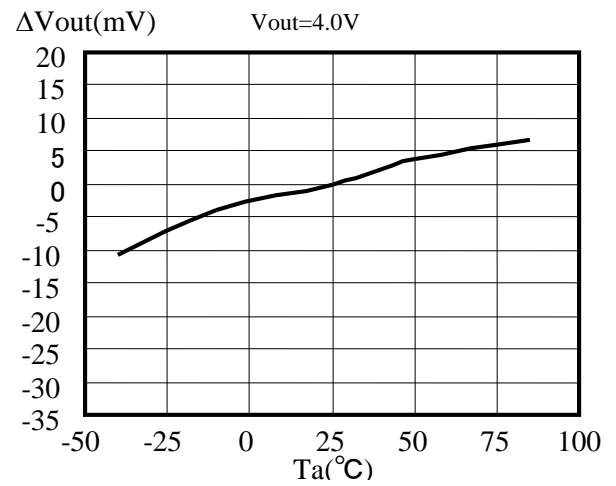
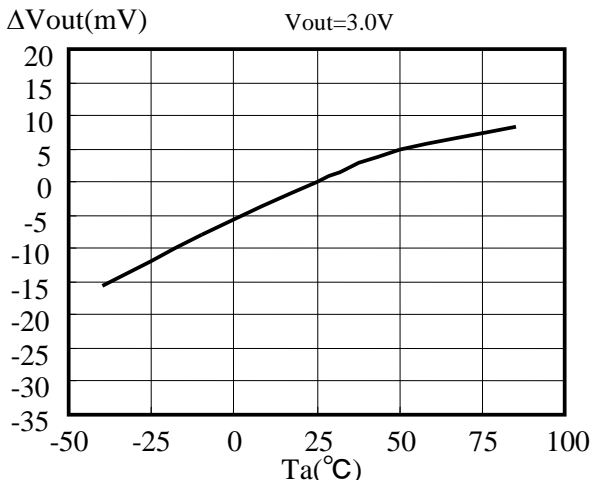
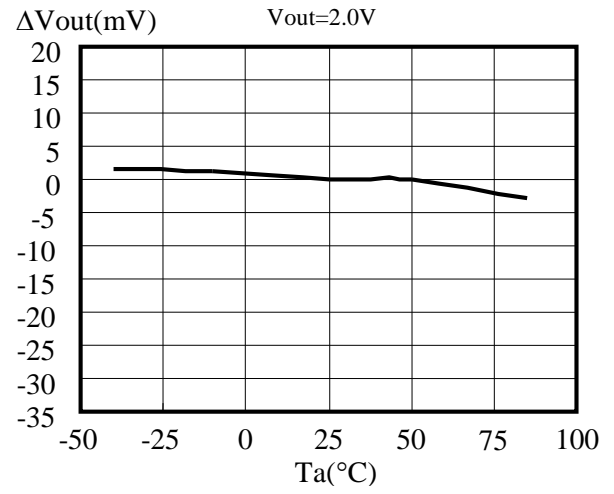
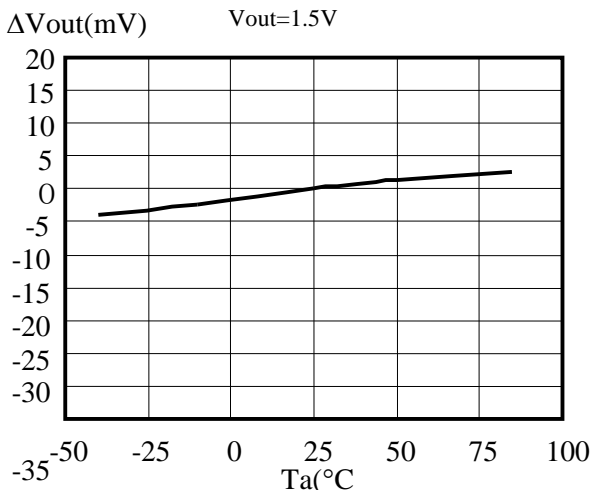

11.6 On/Off Control

It is recommended to turn the regulator Off when the circuit following the regulator is non-operating. A design with little electric power loss can be implemented. We recommend the use of the on/off control of the regulator without using a high side switch to provide an output from the regulator. A highly accurate output voltage with low voltage drop is obtained.

Because the V_{cont} terminal current is small, it is possible to control it directly by CMOS logic. The PULLDOWN resistance ($500k\Omega$) is built into the V_{cont} terminal. The noise and the ripple rejection characteristics depend on the capacitance on the V_{ref} terminal. The ripple rejection characteristic of the low frequency region improves by increasing the capacitance of C_{np} . A standard value is $C_{np}=0.068\mu F$. Increase C_{np} in a design with important output noise and ripple rejection requirements. The IC will not be damaged if the capacitor value is increased. The on/off switching speed changes depending on the N_p terminal capacitance. The switching speed slows when the capacitance is large.

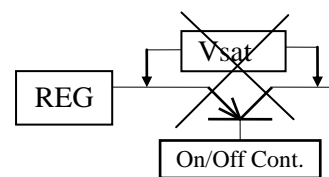

11.7 PCB Layout

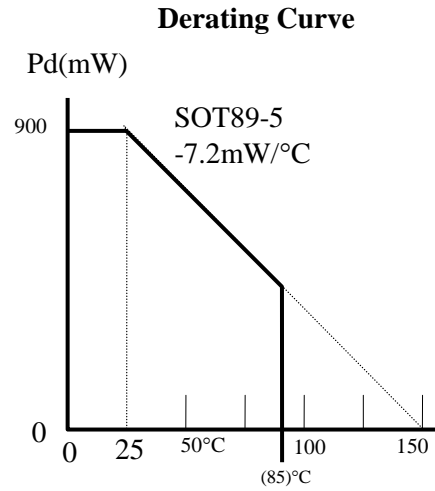
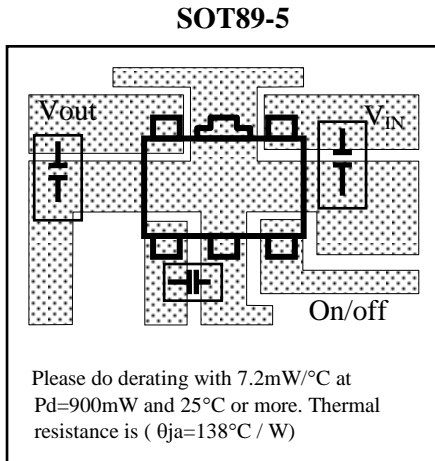

The package loss is limited at the temperature that the internal temperature sensor works (about 150°C). Therefore, the package loss is assumed to be an internal limitation. There is no heat radiation characteristic of the package unit assumed because of the small size. Heat is carried away by the device being installed on the PCB. This value changes by the material and the copper pattern etc. of the PCB. The losses are approximately 900mW(SOT89-5). Enduring these losses becomes possible in a lot of applications operating at 25°C.

Determining the thermal resistance when mounted on a PCB.

The operating chip junction temperature is shown by $T_j = \theta_{ja} \times P_d + T_a$. T_j of the IC is set to about 150°C. P_d is a value when the overtemperature sensor is made to work.

T_a ($T_a=25^\circ\text{C}$)
 $150 = \theta_{ja} \times p_d + 25$
 $\theta_{ja} \times P_d = 125$
 $\theta_{ja} = (125 / p_d) (\text{°C} / \text{mW})$

Pd is easily obtained.

Mount the IC on the PCB. P_d becomes $V_{IN} \times I_{in}$ when the output side of the IC is short-circuited. The input current decreases gradually by the temperature rise of the chip. Please use the value when the current is steady (thermal equilibrium is reached). In many cases, heat radiation is good, and P_d becomes 900 mW or more.

P_d is obtained by the normal temperature in degrees. The current that can be used at the highest operating temperature is obtained from the graph of the figure below.

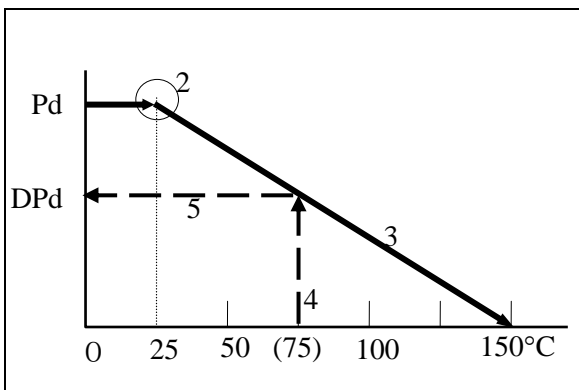

- Procedure (Do when PCB mounted).
1. P_d is obtained ($V_{IN} \times I_{in}$ when the output side is short-circuited).
 2. P_d is plotted on the horizontal line to 25°C.
 3. P_d is connected with the point of 150°C by the straight line (bold face line).
 4. A line is extended vertically above the point of use temperature in the design. For instance, 75°C is assumed (broken line).
 5. Extend the intersection of the derating curve (fat solid line) and (broken line) to the left and read the P_d value.

The maximum current that can be used at the highest operating temperature is:

$$I_{out} \cong DP_d \div (V_{IN(max)} - V_{out}).$$

12. Definition of term

- **Output Voltage (Vout)**

The output voltage is specified with $V_{IN}=(V_{out}(typ)+1V)$ and $I_{out}=5mA$.

- **Maximum Output Current (Iout MAX)**

The rated output current is specified under the condition where the output voltage drops 0.3V the value specified with $I_{out}=5mA$. The input voltage is set to $V_{out}(typ)+1V$ and the current is pulsed to minimize temperature effect.

- **Dropout Voltage (Vdrop)**

The dropout voltage is the difference between the input voltage and the output voltage at which point the regulator starts to fall out of regulation. Below this value, the output voltage will fall as the input voltage is reduced. It is dependent upon the load current and the junction temperature.

- **Line Regulation (LinReg)**

Line regulation is the ability of the regulator to maintain a constant output voltage as the input voltage changes. The line regulation is specified as the input voltage is changed from $V_{IN}=V_{out}(typ)+1V$ to $V_{IN}=V_{out}(typ)+6V$. It is a pulse measurement to minimize temperature effect.

- **Load Regulation (LoaReg)**

Load regulation is the ability of the regulator to maintain a constant output voltage as the load current changes. It is a pulsed measurement to minimize temperature effects with the input voltage set to $V_{IN}=V_{out}(typ)+1V$. The load regulation is specified output current step conditions of 5mA to 100mA.

- **Ripple Rejection (R.R)**

Ripple rejection is the ability of the regulator to attenuate the ripple content of the input voltage at the output. It is specified with $200mV_{rms}$, 1kHz super-imposed on the input voltage, where $V_{IN}=V_{out}+1.5V$. Ripple rejection is the ratio of the ripple content of the output vs. input and is expressed in dB.

- **Standby Current (Istandby)**

Standby current is the current, which flows into the regulator when the output is turned off by the control function ($V_{cont}=0V$).

- **Over Current Sensor**

The over current sensor protects the device when there is excessive output current. It also protects the device if the output is accidentally connected to ground.

- **Thermal Sensor**

The thermal sensor protects the device in case the junction temperature exceeds the safe value ($T_J=150^{\circ}C$). This temperature rise can be caused by external heat, excessive power dissipation caused by large input to output voltage drops, or excessive output current. The regulator will shut off when the temperature exceeds the safe value. As the junction temperatures decrease, the regulator will begin to operate again. Under sustained fault conditions, the regulator output will oscillate as the device turns off then resets. Damage may occur to the device under extreme fault.

Please reduce the loss of the regulator when this protection operate, by reducing the input voltage or make better heat efficiency. In the case that the power, $V_{IN} \times I_{short}$ (Short Circuit Current), becomes more than twice of the maximum rating of its power dissipation in a moment, there is a possibility that the IC is destroyed before internal thermal protection works.

- **Reverse Voltage Protection**

Reverse voltage protection prevents damage due to the output voltage being higher than the input voltage. This fault condition can occur when the output capacitor remains charged and the input is reduced to zero, or when an external voltage higher than the input voltage is applied to the output side

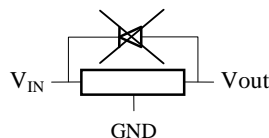

13. Recommended External Circuits

■ External Circuit

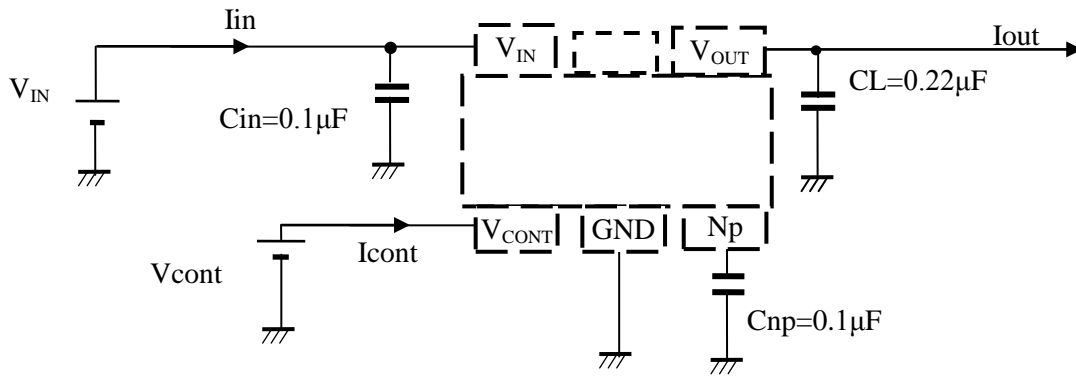
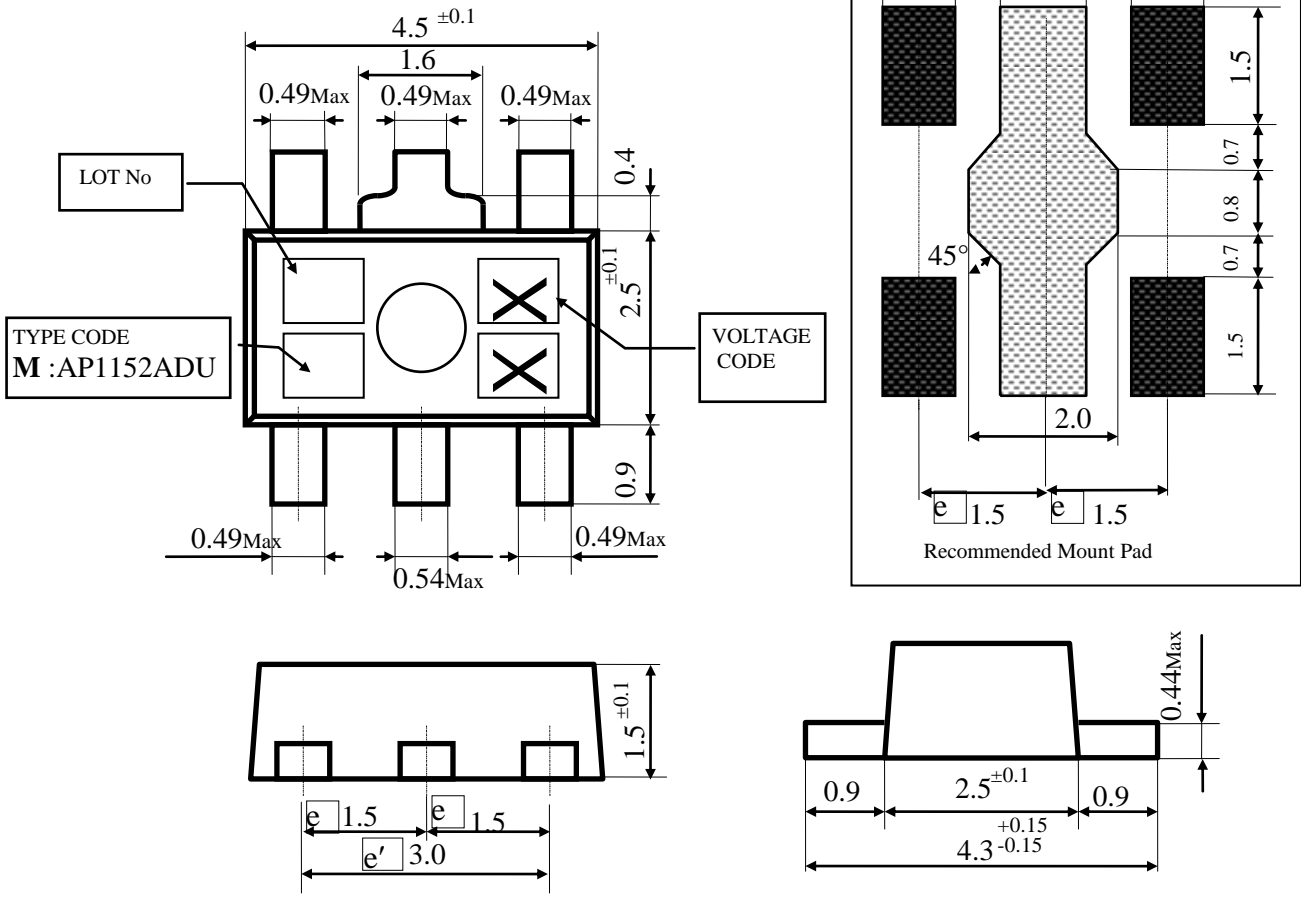

Figure 3. External Circuit (the case of $C_L = 0.22\mu F$)

14. Package

■ Outline Dimensions



Unit : mm
 General tolerance : ± 0.2

15. Revise History

Date (YY/MM/DD)	Revision	Page	Contents
14/10/29	00	-	First Edition
14/12/05	01	24	Changed horizontal width dimension tolerance of the package ; 4.5±0.2 to 4.5±0.1 Changed vertical width dimension tolerance of the package ; 2.5±0.2 to 2.5±0.1(without pin length) Changed vertical width dimension tolerance of the package ; 4.5+0.5/-0.3 to 4.3+0.15/-0.15 (with pin length) Changed height dimension tolerance of the package ; 1.5±0.2 to 1.5±0.1 Changed pin length ; 1.0→0.9 Add General tolerance : ±0.2

IMPORTANT NOTICE

0. Asahi Kasei Microdevices Corporation (“AKM”) reserves the right to make changes to the information contained in this document without notice. When you consider any use or application of AKM product stipulated in this document (“Product”), please make inquiries the sales office of AKM or authorized distributors as to current status of the Products.
1. All information included in this document are provided only to illustrate the operation and application examples of AKM Products. AKM neither makes warranties or representations with respect to the accuracy or completeness of the information contained in this document nor grants any license to any intellectual property rights or any other rights of AKM or any third party with respect to the information in this document. You are fully responsible for use of such information contained in this document in your product design or applications. **AKM ASSUMES NO LIABILITY FOR ANY LOSSES INCURRED BY YOU OR THIRD PARTIES ARISING FROM THE USE OF SUCH INFORMATION IN YOUR PRODUCT DESIGN OR APPLICATIONS.**
2. The Product is neither intended nor warranted for use in equipment or systems that require extraordinarily high levels of quality and/or reliability and/or a malfunction or failure of which may cause loss of human life, bodily injury, serious property damage or serious public impact, including but not limited to, equipment used in nuclear facilities, equipment used in the aerospace industry, medical equipment, equipment used for automobiles, trains, ships and other transportation, traffic signaling equipment, equipment used to control combustions or explosions, safety devices, elevators and escalators, devices related to electric power, and equipment used in finance-related fields. Do not use Product for the above use unless specifically agreed by AKM in writing.
3. Though AKM works continually to improve the Product’s quality and reliability, you are responsible for complying with safety standards and for providing adequate designs and safeguards for your hardware, software and systems which minimize risk and avoid situations in which a malfunction or failure of the Product could cause loss of human life, bodily injury or damage to property, including data loss or corruption.
4. Do not use or otherwise make available the Product or related technology or any information contained in this document for any military purposes, including without limitation, for the design, development, use, stockpiling or manufacturing of nuclear, chemical, or biological weapons or missile technology products (mass destruction weapons). When exporting the Products or related technology or any information contained in this document, you should comply with the applicable export control laws and regulations and follow the procedures required by such laws and regulations. The Products and related technology may not be used for or incorporated into any products or systems whose manufacture, use, or sale is prohibited under any applicable domestic or foreign laws or regulations.
5. Please contact AKM sales representative for details as to environmental matters such as the RoHS compatibility of the Product. Please use the Product in compliance with all applicable laws and regulations that regulate the inclusion or use of controlled substances, including without limitation, the EU RoHS Directive. AKM assumes no liability for damages or losses occurring as a result of noncompliance with applicable laws and regulations.
6. Resale of the Product with provisions different from the statement and/or technical features set forth in this document shall immediately void any warranty granted by AKM for the Product and shall not create or extend in any manner whatsoever, any liability of AKM.
7. This document may not be reproduced or duplicated, in any form, in whole or in part, without prior written consent of AKM.