

**OFFLINE, HIGH PF, HIGH EFFICIENCY DIMMABLE LED DRIVER CONTROLLER**

NEW PRODUCT

**Description**

The AP1694 is a high performance AC/DC power factor corrector for mains dimmable LED driver applications. The device uses Pulse Frequency Modulation (PFM) technology to regulate output current while achieving high power factor and low THD. It operates as a BCM (Boundary Conduction Mode) controller which is good for EMI.

The AP1694 provides accurate constant current (CC) regulation while removing the opto-coupler and secondary control circuitry. It also eliminates the need of loop compensation circuitry while maintaining stability. It can meet the requirement of IEC6100-3-2 harmonic standard.

The AP1694 features low start-up current, low operation current. It adopts dynamic base driver control technology and valley on switching mode to achieve high efficiency. It also has rich protection features including over voltage, short circuit, over temperature protection.

The AP1694 provides the dimmable LED driver with a wide dimmer compatibility including leading edge and trailing edge dimmer. The AP1694 can achieve deep dimming down to 1%, while the dimming curve is compliant with the standard of NEMA SSL6.

The AP1694 is available in SO-8 package.

**Pin Assignments**

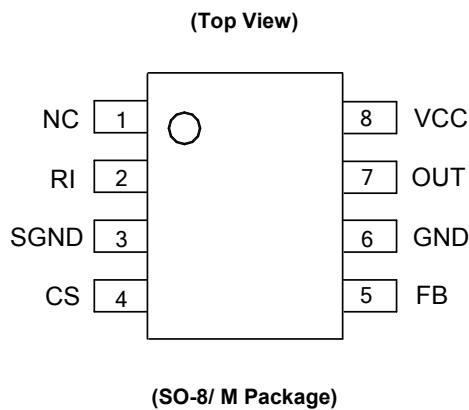

**Features**

- Primary Side Control for Output Current Regulation without Opto-coupler
- Boundary Conduction Mode (BCM) Operation to Achieve High-efficiency
- High PF and Low THD
- High Efficiency without Dimmer
- Wide Range of Dimmer Compatibility
- Dimming Curve Compliant with NEMA SSL6
- Low Start-up Current
- Tight LED Current
- Tight LED Open Voltage
- BJT Transistor Driver
- Dynamic Base Driver Control
- Valley-mode Switching to Minimize the Transition Loss
- Easy EMI
- Internal Protections:
  - Under Voltage Lock Out (UVLO)
  - Leading-edge Blanking (LEB)
  - Output Short Protection
  - Output Open Protection
  - Over Temperature Protection
- Flexible for Design with Small Form Factor and Very Low BOM Cost
- **Totally Lead-Free & Fully RoHS Compliant (Notes 1 & 2)**
- **Halogen and Antimony Free. "Green" Device (Note 3)**

**Applications**

- Mains Dimmable LED Lighting

Notes:

1. No purposely added lead. Fully EU Directive 2002/95/EC (RoHS) & 2011/65/EU (RoHS 2) compliant.
2. See [http://www.diodes.com/quality/lead\\_free.html](http://www.diodes.com/quality/lead_free.html) for more information about Diodes Incorporated's definitions of Halogen- and Antimony-free, "Green" and Lead-free.
3. Halogen- and Antimony-free "Green" products are defined as those which contain <900ppm bromine, <900ppm chlorine (<1500ppm total Br + Cl) and <1000ppm antimony compounds.

**Typical Applications Circuit**

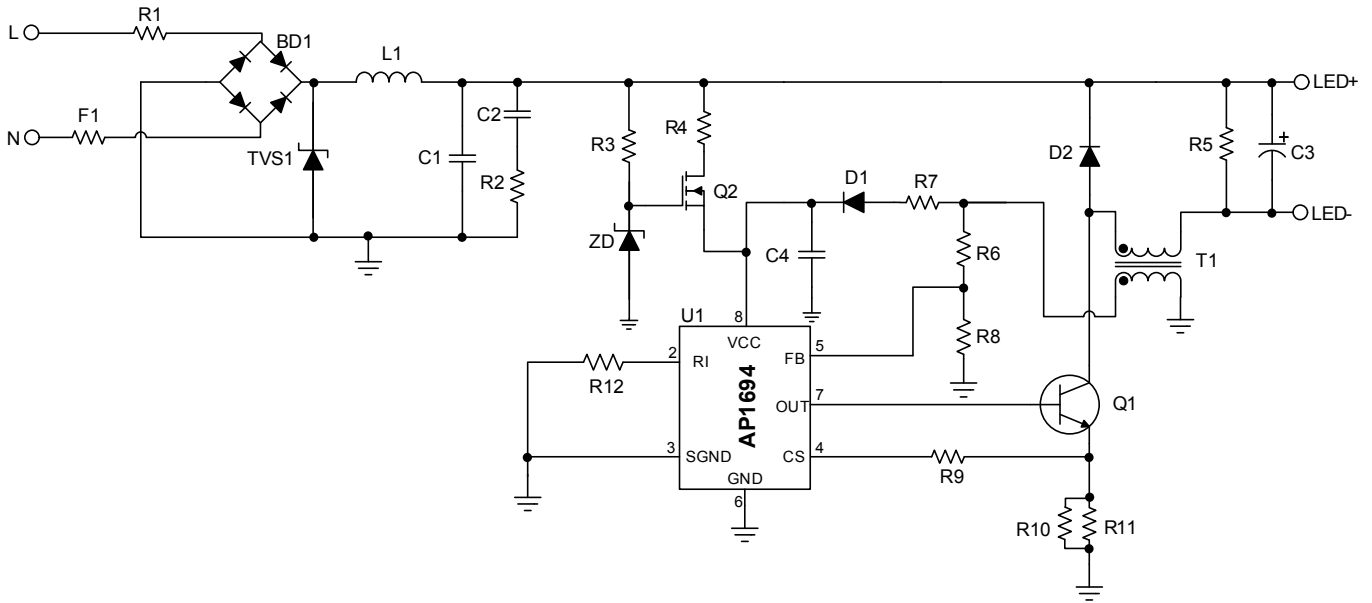

**Pin Descriptions**

Pin Number	Pin Name	Function
1	NC	No connection.
2	RI	The initial on time setting resistor.
3	SGND	Must connect to GND.
4	CS	Primary current sensing.
5	FB	The feedback voltage from auxiliary winding
6	GND	Ground.
7	OUT	Gate driver output.
8	VCC	Supply voltage of gate driver and control circuits of the IC.

NEW PRODUCT

**Functional Block Diagram**

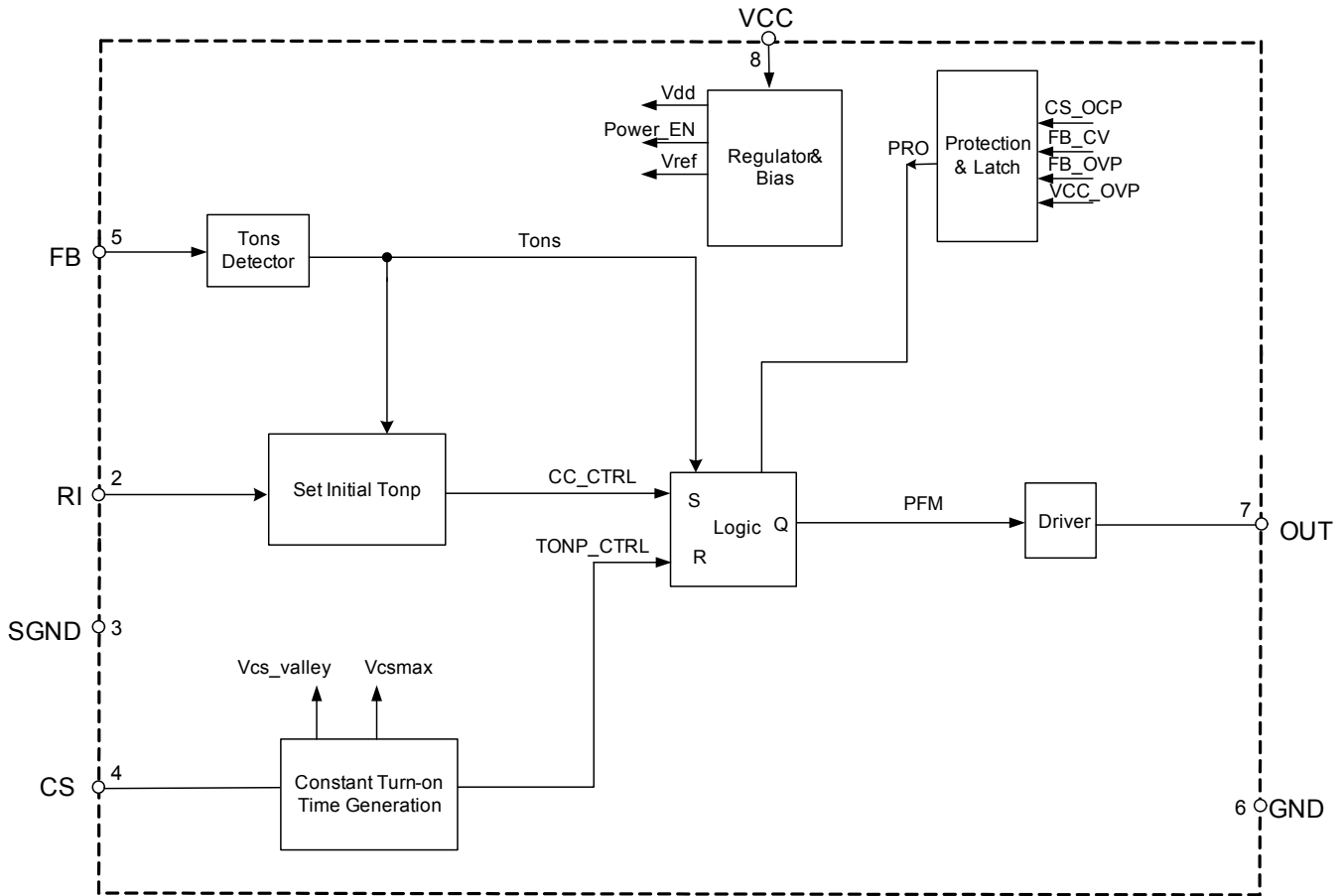

**Absolute Maximum Ratings** (Note 4) (@ $T_A = +25^{\circ}\text{C}$ , unless otherwise specified.)

Symbol	Parameter	Rating	Unit
$V_{CC}$	Power Supply Voltage	-0.3 to 35	V
$I_{OUT}$	Driver Output Current	150	mA
$V_{CS}$	Voltage at CS to GND	-0.3 to 7	V
$V_{FB}$	FB Input Voltage	-40 to 10	V
$T_J$	Operating Junction Temperature	-40 to +150	$^{\circ}\text{C}$
$T_{STG}$	Storage Temperature	-65 to +150	$^{\circ}\text{C}$
$T_{LEAD}$	Lead Temperature (Soldering, 10 sec)	+300	$^{\circ}\text{C}$
$P_D$	Power Dissipation ( $T_A = +50^{\circ}\text{C}$ )	0.65	W
$\theta_{JA}$	Thermal Resistance (Junction to Ambient)	160	$^{\circ}\text{C}/\text{W}$
-	ESD (Human Body Model)	2000	V
-	ESD (Charged-device Model)	$\pm 1000$	V

Note: 4. Stresses greater than those listed under "Absolute Maximum Ratings" may cause permanent damage to the device. These are stress ratings only, and functional operation of the device at these or any other conditions beyond those indicated under "Recommended Operating Conditions" is not implied. Exposure to "Absolute Maximum Ratings" for extended periods may affect device reliability.

## Recommended Operating Conditions

Symbol	Parameter	Min	Max	Unit
V <sub>CC</sub>	Power Supply Voltage	7	25	V
T <sub>A</sub>	Ambient Temperature	-40	+105	°C

## Electrical Characteristics (@T<sub>A</sub> = +25°C, unless otherwise specified.)

Symbol	Parameter	Conditions	Min	Typ	Max	Unit
<b>UVLO Section</b>						
V <sub>TH</sub> (ST)	Start-up Threshold	–	13	14.5	16	V
V <sub>OPR</sub> (Min)	Minimum Operating Voltage	After turn on	5.5	6.5	7.5	V
V <sub>CC_OVP</sub>	VCC OVP Voltage	–	27	29	31	V
–	VCC Delatch Voltage (Note 5)	–	3	4	5	V
<b>Standby Current Section</b>						
I <sub>ST</sub>	Start-up Current	V <sub>CC</sub> = V <sub>TH</sub> (ST) - 0.5V, Before start up	–	–	20	µA
I <sub>CC</sub> (OPR)	Operating Current	Static	–	900	1300	µA
<b>Drive Output Section</b>						
I <sub>OUT</sub>	Output Current (Note 5)	V <sub>CS_PEAK</sub> = 1V	–	–	60	mA
V <sub>OS</sub>	UVLO Saturation Voltage	V <sub>CC</sub> = 0 to V <sub>CC-ON</sub> , I <sub>SINK</sub> = 10mA	–	–	1.1	V
<b>Current Sense Section</b>						
V <sub>CS_REF</sub>	Current Sense Reference	–	–	1	–	V
V <sub>CS_CLAMP</sub>	Current Sense Reference Clamp	–	1.2	1.4	–	V
t <sub>ONP_MIN</sub>	Minimum t <sub>ONP</sub>	–	700	–	1000	ns
t <sub>D(H-L)</sub>	Delay to Output (Note 5)	–	50	150	250	ns
<b>Feedback Input Section</b>						
I <sub>FB</sub>	Feedback Pin Input Leakage Current	V <sub>FB</sub> = 2V	–	–	4	µA
V <sub>FB_CV</sub>	FB CV Threshold	–	3.8	4	4.2	V
V <sub>FB_OVP</sub>	FB OVP Threshold	–	4.5	6	7.5	V
<b>Output Current</b>						
–	System Output Current On Final Test Board	–	–	–	±2	%
<b>Over Temperature Protection Section</b>						
–	Shutdown Temperature (Note 5)	–	+150	–	–	°C
–	Temperature Hysteresis (Note 5)	–	–	+20	–	°C

Note: 5. These parameters, although guaranteed by design, are not 100% tested in production.

**Performance Characteristics**

NEW PRODUCT

**CV Threshold vs. Supply Voltage**

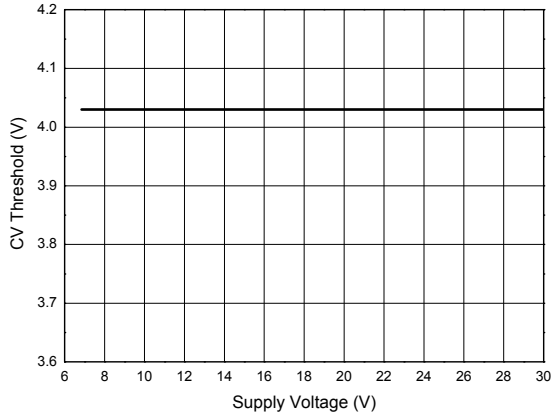

**Start-up Voltage vs. Ambient Temperature**

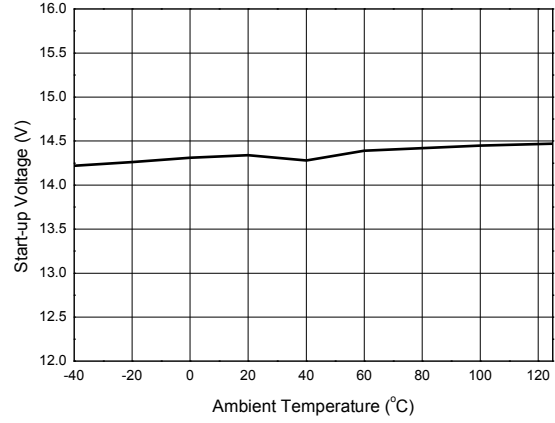

**Minimal Operating Voltage vs. Ambient Temperature**

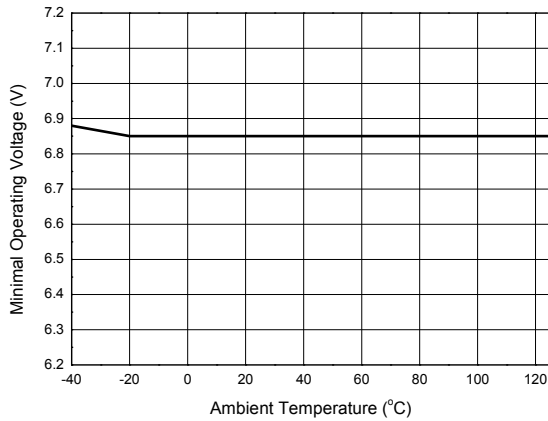

**Start-up Current vs. Ambient Temperature**

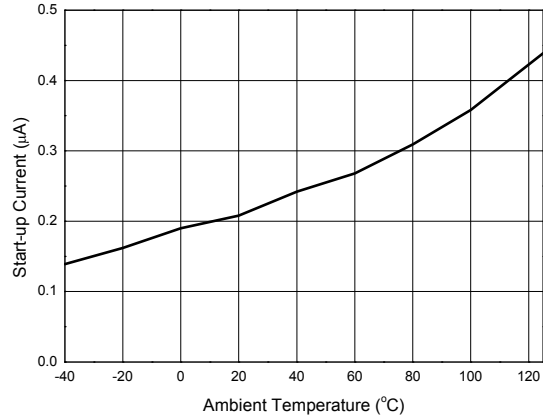

**Operating Current vs. Ambient Temperature**

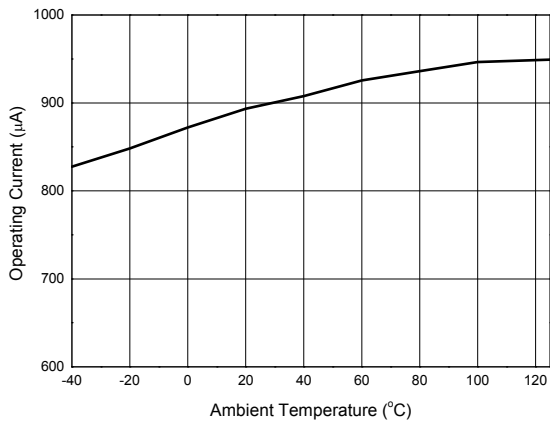

**CV Threshold vs. Ambient Temperature**

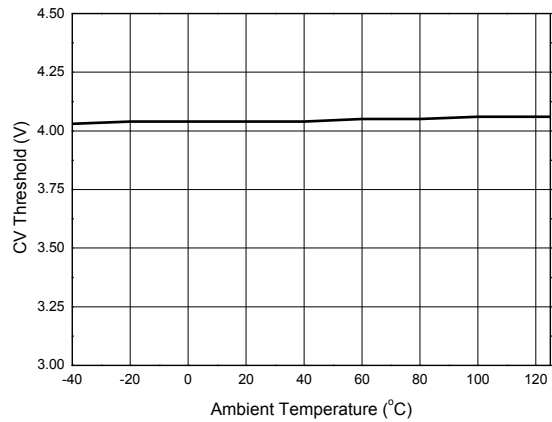

**Performance Characteristics (Cont.)**

**FB Leakage Current vs. Ambient Temperature**

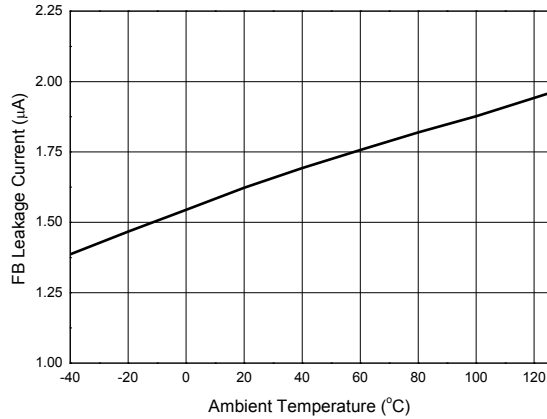

**Supply Current vs. Supply Voltage**

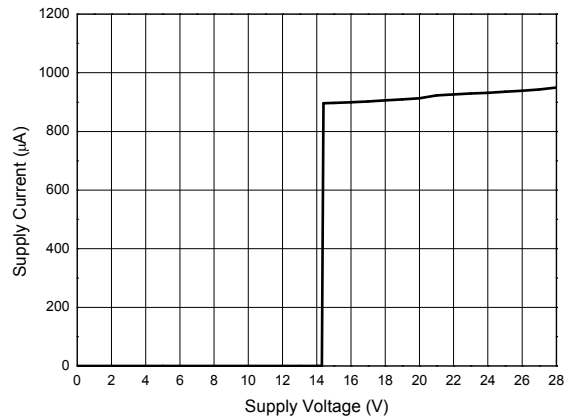

**Ordering Information**

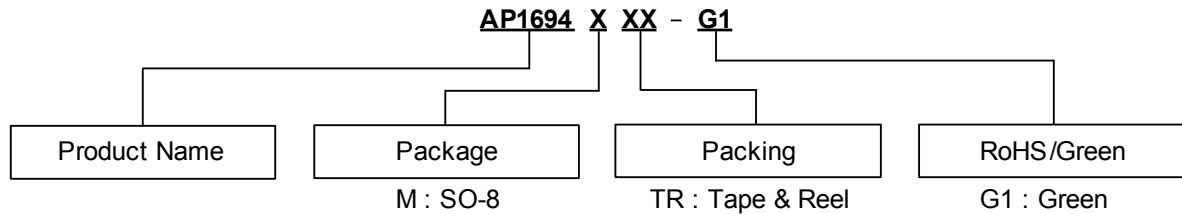

Diodes IC's Pb-free products with "G1" suffix in the part number, are RoHS compliant and green.

Package	Ambient Temperature Range	Part Number	Marking ID	Packing
SO-8	-40°C to +105°C	AP1694MTR-G1	1694M-G1	4000/13" Tape & Reel

**Marking Information**

(Top View)

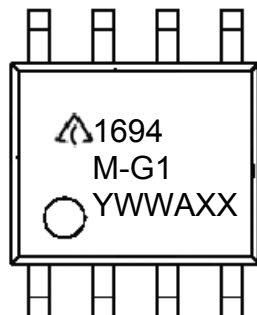

First and Second Lines: Logo and Marking ID  
(See Ordering Information)  
Third Line: Date Code  
Y: Year  
WW: Work Week of Molding  
A: Assembly House Code  
XX: 7<sup>th</sup> and 8<sup>th</sup> Digits of Batch No.



**Suggested Pad Layout**

(1) Package Type: SO-8

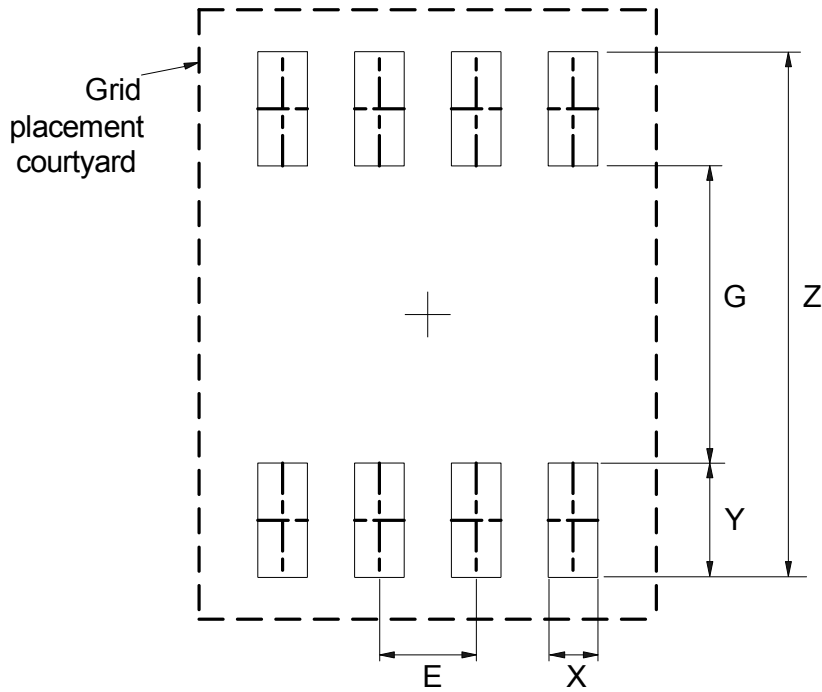

Dimensions	Z (mm)/(inch)	G (mm)/(inch)	X (mm)/(inch)	Y (mm)/(inch)	E (mm)/(inch)
Value	6.900/0.272	3.900/0.154	0.650/0.026	1.500/0.059	1.270/0.050

NEW PRODUCT



**IMPORTANT NOTICE**

DIODES INCORPORATED MAKES NO WARRANTY OF ANY KIND, EXPRESS OR IMPLIED, WITH REGARDS TO THIS DOCUMENT, INCLUDING, BUT NOT LIMITED TO, THE IMPLIED WARRANTIES OF MERCHANTABILITY AND FITNESS FOR A PARTICULAR PURPOSE (AND THEIR EQUIVALENTS UNDER THE LAWS OF ANY JURISDICTION).

Diodes Incorporated and its subsidiaries reserve the right to make modifications, enhancements, improvements, corrections or other changes without further notice to this document and any product described herein. Diodes Incorporated does not assume any liability arising out of the application or use of this document or any product described herein; neither does Diodes Incorporated convey any license under its patent or trademark rights, nor the rights of others. Any Customer or user of this document or products described herein in such applications shall assume all risks of such use and will agree to hold Diodes Incorporated and all the companies whose products are represented on Diodes Incorporated website, harmless against all damages.

Diodes Incorporated does not warrant or accept any liability whatsoever in respect of any products purchased through unauthorized sales channel. Should Customers purchase or use Diodes Incorporated products for any unintended or unauthorized application, Customers shall indemnify and hold Diodes Incorporated and its representatives harmless against all claims, damages, expenses, and attorney fees arising out of, directly or indirectly, any claim of personal injury or death associated with such unintended or unauthorized application.

Products described herein may be covered by one or more United States, international or foreign patents pending. Product names and markings noted herein may also be covered by one or more United States, international or foreign trademarks.

This document is written in English but may be translated into multiple languages for reference. Only the English version of this document is the final and determinative format released by Diodes Incorporated.

**LIFE SUPPORT**

Diodes Incorporated products are specifically not authorized for use as critical components in life support devices or systems without the express written approval of the Chief Executive Officer of Diodes Incorporated. As used herein:

A. Life support devices or systems are devices or systems which:

1. are intended to implant into the body, or
2. support or sustain life and whose failure to perform when properly used in accordance with instructions for use provided in the labeling can be reasonably expected to result in significant injury to the user.

B. A critical component is any component in a life support device or system whose failure to perform can be reasonably expected to cause the failure of the life support device or to affect its safety or effectiveness.

Customers represent that they have all necessary expertise in the safety and regulatory ramifications of their life support devices or systems, and acknowledge and agree that they are solely responsible for all legal, regulatory and safety-related requirements concerning their products and any use of Diodes Incorporated products in such safety-critical, life support devices or systems, notwithstanding any devices- or systems-related information or support that may be provided by Diodes Incorporated. Further, Customers must fully indemnify Diodes Incorporated and its representatives against any damages arising out of the use of Diodes Incorporated products in such safety-critical, life support devices or systems.

Copyright © 2013, Diodes Incorporated

[www.diodes.com](http://www.diodes.com)