

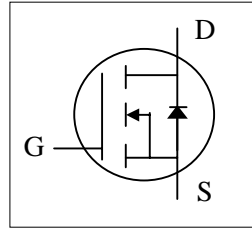

- ▼ Low Gate Charge
- ▼ Simple Drive Requirement
- ▼ Fast Switching Characteristic
- ▼ RoHS Compliant & Halogen-Free



| | |
|--------------|---------------|
| BV_{DSS} | 200V |
| $R_{DS(ON)}$ | 170m Ω |
| I_D | 18A |

Description

AP18N20 series are from Advanced Power innovated design and silicon process technology to achieve the lowest possible on-resistance and fast switching performance. It provides the designer with an extreme efficient device for use in a wide range of power applications. The TO-263 package is widely preferred for all commercial-industrial surface mount applications using infrared reflow technique and suited for high current application due to the low connection resistance. The through-hole version (AP18N20GP) are available for low-profile applications.

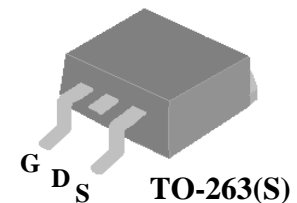
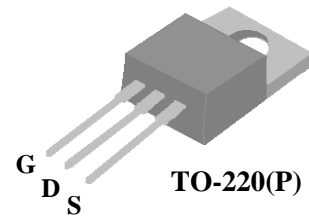

Absolute Maximum Ratings @ $T_j=25^\circ\text{C}$ (unless otherwise specified)

| Symbol | Parameter | Rating | Units |
|-------------------------------|--------------------------------------|------------|---------------------|
| V_{DS} | Drain-Source Voltage | 200 | V |
| V_{GS} | Gate-Source Voltage | ± 20 | V |
| $I_D @ T_C=25^\circ\text{C}$ | Drain Current, $V_{GS} @ 10\text{V}$ | 18 | A |
| $I_D @ T_C=100^\circ\text{C}$ | Drain Current, $V_{GS} @ 10\text{V}$ | 9.5 | A |
| I_{DM} | Pulsed Drain Current ¹ | 60 | A |
| $P_D @ T_C=25^\circ\text{C}$ | Total Power Dissipation | 89 | W |
| | Linear Derating Factor | 0.7 | W/ $^\circ\text{C}$ |
| T_{STG} | Storage Temperature Range | -55 to 150 | $^\circ\text{C}$ |
| T_J | Operating Junction Temperature Range | -55 to 150 | $^\circ\text{C}$ |

Thermal Data

| Symbol | Parameter | Value | Units |
|--------|---|-------|---------------------------|
| Rthj-c | Maximum Thermal Resistance, Junction-case | 1.4 | $^\circ\text{C}/\text{W}$ |
| Rthj-a | Maximum Thermal Resistance, Junction-ambient (PCB mount) ³ | 40 | $^\circ\text{C}/\text{W}$ |
| Rthj-a | Maximum Thermal Resistance, Junction-ambient | 62 | $^\circ\text{C}/\text{W}$ |



AP18N20GS/P-HF

Electrical Characteristics @T_j=25°C(unless otherwise specified)

| Symbol | Parameter | Test Conditions | Min. | Typ. | Max. | Units |
|---------------------|--|--|------|------|------|-------|
| BV _{DSS} | Drain-Source Breakdown Voltage | V _{GS} =0V, I _D =1mA | 200 | - | - | V |
| R _{DS(ON)} | Static Drain-Source On-Resistance | V _{GS} =10V, I _D =8A | - | - | 170 | mΩ |
| V _{GS(th)} | Gate Threshold Voltage | V _{DS} =V _{GS} , I _D =250uA | 2 | - | 4 | V |
| g _{fs} | Forward Transconductance | V _{DS} =10V, I _D =10A | - | 9.5 | - | S |
| I _{DSS} | Drain-Source Leakage Current | V _{DS} =200V, V _{GS} =0V | - | - | 10 | uA |
| | Drain-Source Leakage Current (T _j =125°C) | V _{DS} =160V, V _{GS} =0V | - | - | 250 | uA |
| I _{GSS} | Gate-Source Leakage | V _{GS} =±20V, V _{DS} =0V | - | - | ±100 | nA |
| Q _g | Total Gate Charge ² | I _D =10A | - | 19 | 30 | nC |
| Q _{gs} | Gate-Source Charge | V _{DS} =160V | - | 5 | - | nC |
| Q _{gd} | Gate-Drain ("Miller") Charge | V _{GS} =10V | - | 6 | - | nC |
| t _{d(on)} | Turn-on Delay Time ² | V _{DD} =100V | - | 9 | - | ns |
| t _r | Rise Time | I _D =11A | - | 21 | - | ns |
| t _{d(off)} | Turn-off Delay Time | R _G =9.1 Ω | - | 25 | - | ns |
| t _f | Fall Time | V _{GS} =10V | - | 19 | - | ns |
| C _{iss} | Input Capacitance | V _{GS} =0V | - | 1065 | 1700 | pF |
| C _{oss} | Output Capacitance | V _{DS} =25V | - | 185 | - | pF |
| C _{rss} | Reverse Transfer Capacitance | f=1.0MHz | - | 3 | - | pF |
| R _g | Gate Resistance | f=1.0MHz | - | 1.6 | 2.4 | Ω |

Source-Drain Diode

| Symbol | Parameter | Test Conditions | Min. | Typ. | Max. | Units |
|-----------------|---------------------------------|--|------|------|------|-------|
| V _{SD} | Forward On Voltage ² | I _S =10A, V _{GS} =0V | - | - | 1.3 | V |
| t _{rr} | Reverse Recovery Time | I _S =10A, V _{GS} =0V | - | 180 | - | ns |
| Q _{rr} | Reverse Recovery Charge | dI/dt=100A/μs | - | 1150 | - | nC |

Notes:

- 1.Pulse width limited by Maximum junction temperature.
- 2.Pulse test
- 3.Surface mounted on 1 in² copper pad of FR4 board

THIS PRODUCT IS SENSITIVE TO ELECTROSTATIC DISCHARGE, PLEASE HANDLE WITH CAUTION.

USE OF THIS PRODUCT AS A CRITICAL COMPONENT IN LIFE SUPPORT OR OTHER SIMILAR SYSTEMS IS NOT AUTHORIZED.

APEC DOES NOT ASSUME ANY LIABILITY ARISING OUT OF THE APPLICATION OR USE OF ANY PRODUCT OR CIRCUIT DESCRIBED HEREIN; NEITHER DOES IT CONVEY ANY LICENSE UNDER ITS PATENT RIGHTS, NOR THE RIGHTS OF OTHERS.

APEC RESERVES THE RIGHT TO MAKE CHANGES WITHOUT FURTHER NOTICE TO ANY PRODUCTS HEREIN TO IMPROVE RELIABILITY, FUNCTION OR DESIGN.

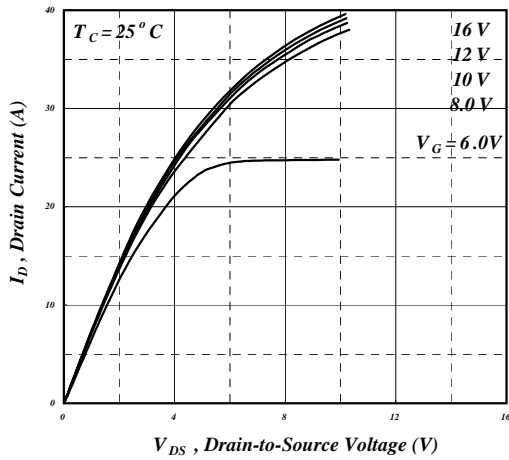

Fig 1. Typical Output Characteristics

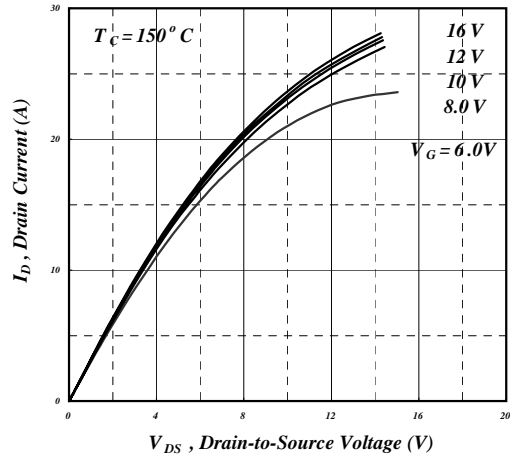

Fig 2. Typical Output Characteristics

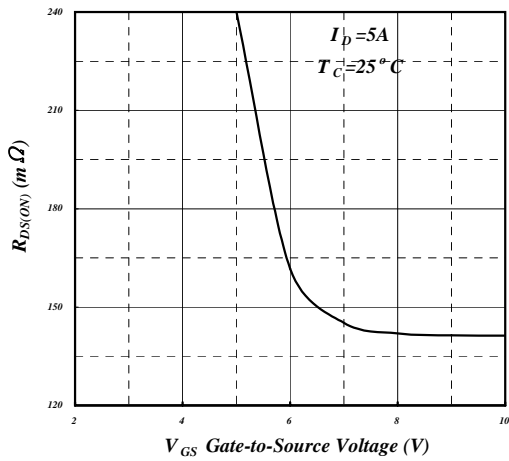

Fig 3. On-Resistance v.s. Gate Voltage

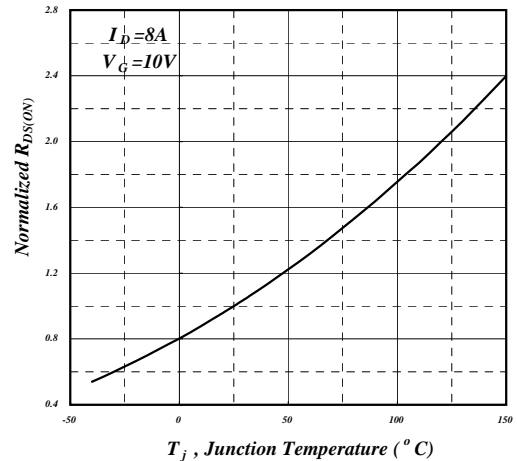

Fig 4. Normalized On-Resistance v.s. Junction Temperature

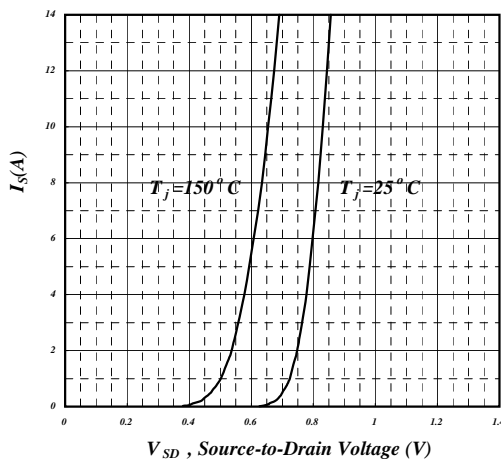

Fig 5. Forward Characteristic of Reverse Diode

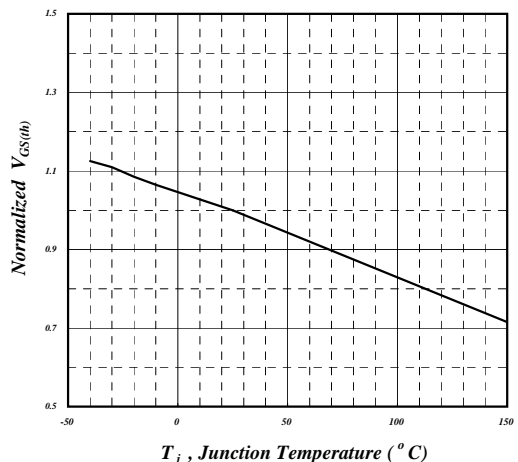

Fig 6. Gate Threshold Voltage v.s. Junction Temperature



AP18N20GS/P-HF

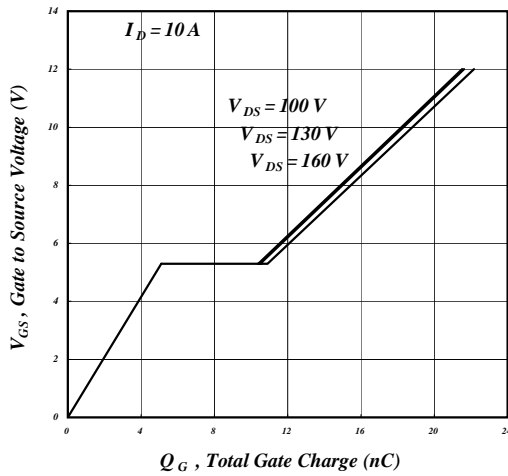

Fig 7. Gate Charge Characteristics

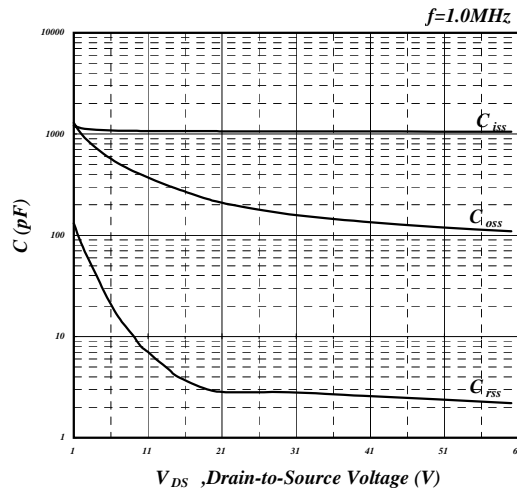

Fig 8. Typical Capacitance Characteristics

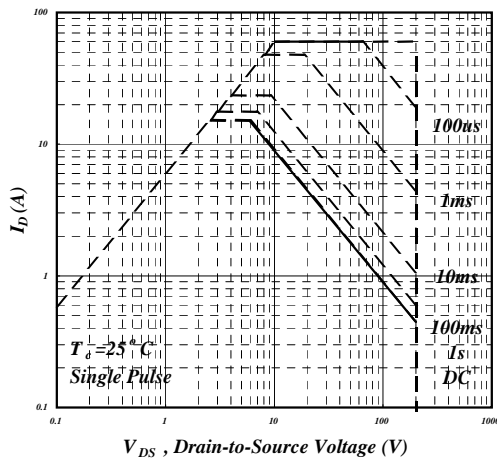

Fig 9. Maximum Safe Operating Area

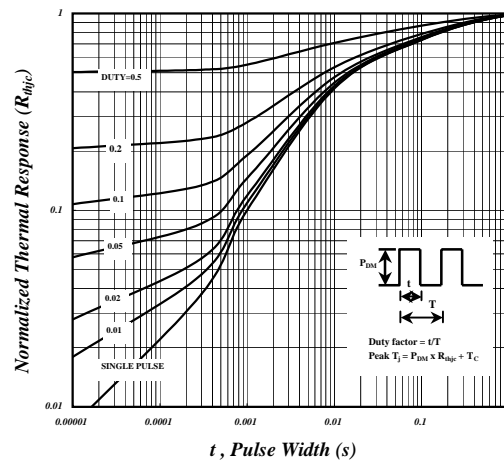

Fig 10. Effective Transient Thermal Impedance

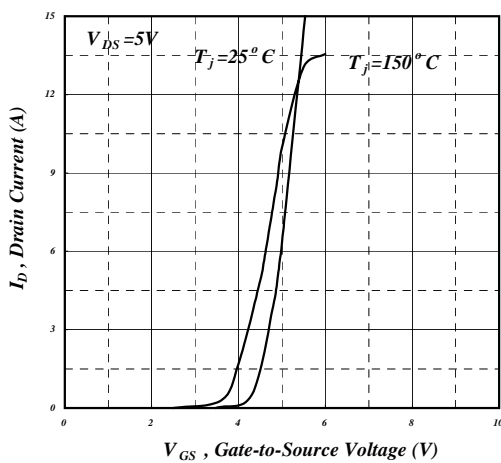

Fig 11. Transfer Characteristics

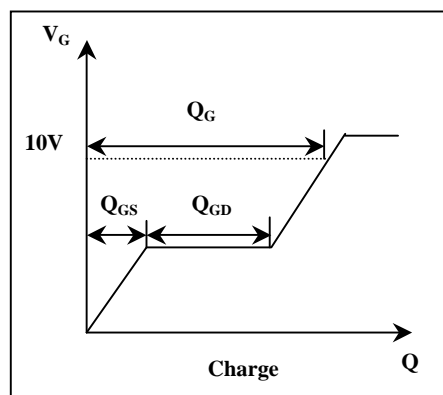
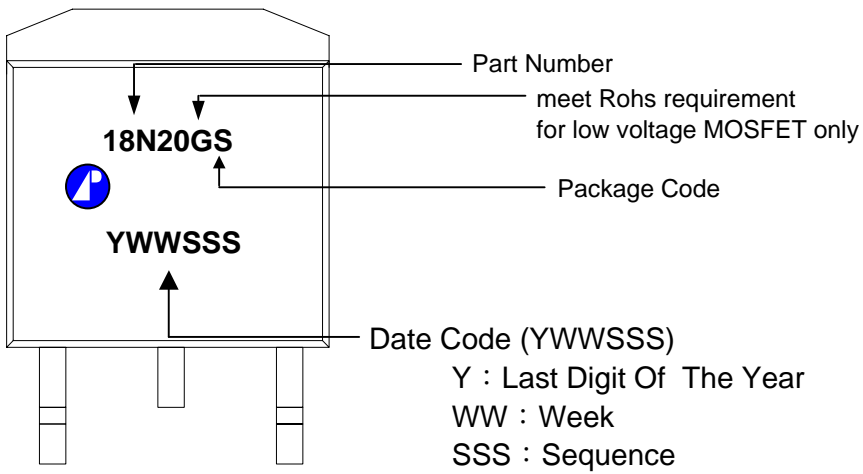

Fig 12. Gate Charge Waveform



MARKING INFORMATION

TO-263



TO-220

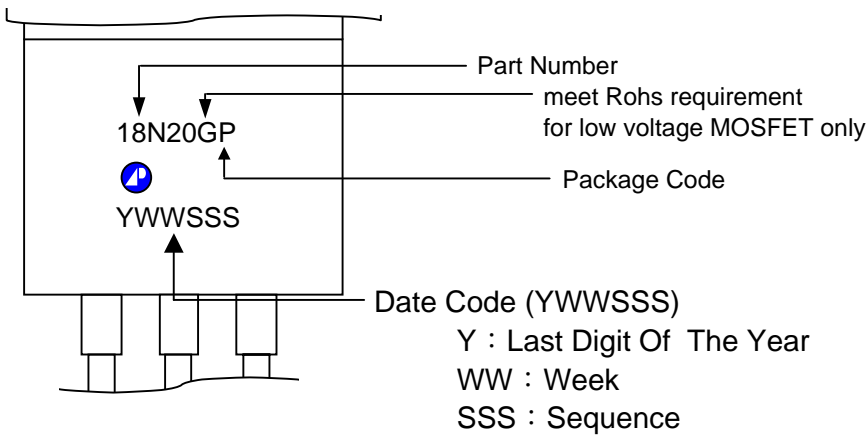



Package Outline : TO-263

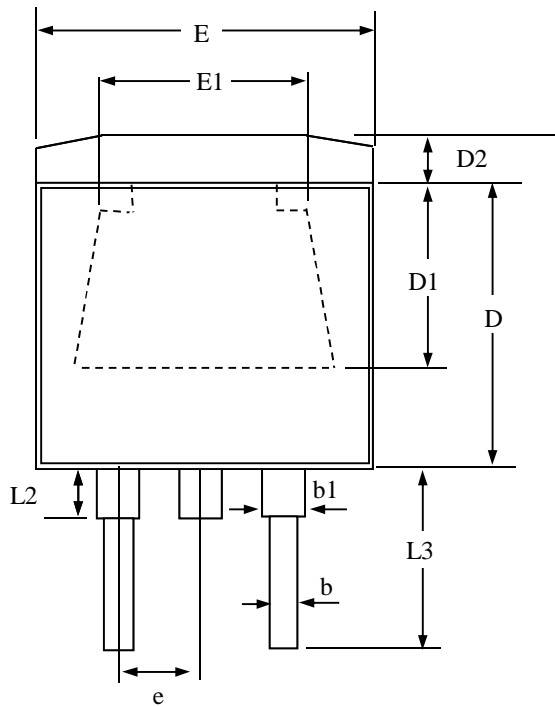

| SYMBOLS | Millimeters | | |
|----------|----------------|-------|-------|
| | MIN | NOM | MAX |
| A | 4.00 | 4.75 | 5.20 |
| A1 | 0.00 | 0.15 | 0.30 |
| b | 0.50 | 0.90 | 1.10 |
| b1 | 1.07 | 1.27 | 1.47 |
| c | 0.30 | 0.55 | 0.80 |
| c1 | 1.10 | 1.40 | 1.70 |
| D | 8.30 | 9.05 | 9.80 |
| D1 | 5.10(ref) | | |
| D2 | 1.27(ref) | | |
| E | 9.50 | 10.10 | 10.70 |
| E1 | 7.00~9.00(ref) | | |
| e | 2.04 | 2.54 | 3.04 |
| L1 | 2.54(ref) | | |
| L2 | 1.5 (ref) | | |
| L3 | 3.50 | 4.50 | 5.50 |
| θ | 0° | ----- | 8° |

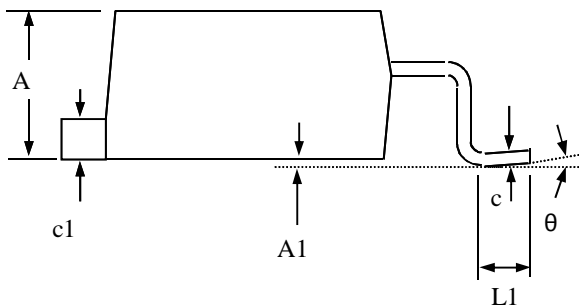

1.All Dimensions Are in Millimeters.

2.Dimension Does Not Include Mold Protrusions.



TO-263 FOOTPRINT :

