

**150mA RF ULDO REGULATOR****AP2201****General Description**

The AP2201 is a 150mA output current fixed voltage regulator designed to provide very low noise ( $45\mu\text{Vrms}$  at 80Hz-100KHz), ultra low dropout voltage (typically 165mV at 150mA), very low quiescent current ( $1\mu\text{A}$  maximum) and excellent power supply ripple rejection (PSRR 75dB at 100Hz) in battery powered applications, such as handsets and PDAs and in noise sensitive applications, such as RF electronics.

The AP2201 also features individual logic compatible enable/shutdown control inputs, a low power shutdown mode for extended battery life, over current protection, over temperature protection, as well as reversed-battery protection.

The output capacitor of  $1.0\mu\text{F}$  minimum and  $2.2\mu\text{F}$  minimum near its pin are recommended when  $C_{\text{BYP}}$  is not used and when  $C_{\text{BYP}}$  is 470pF respectively. The output capacitor should have  $5\Omega$  or less ESR, tantalum or aluminium electrolytic capacitors are adequate. Bypass capacitor is connected to the internal voltage reference to quiet noise. Its recommended value is from 470pF to 1nF. If output noise is not a major concern and rapid turn-on is necessary, omit  $C_{\text{BYP}}$  and leave BYP open.

The AP2201 has 2.6V, 2.8V and 3.0V versions now.

The AP2201 is available in space saving 5-pin SOT-23-5 package.

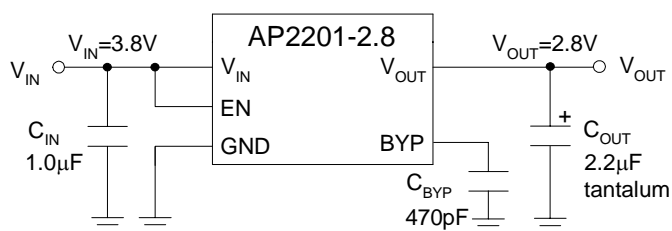

Figure 1. Typical Application of AP2201

**Features**

- Up to 150mA Regulator Output
- Low Quiescent Current
- Low Dropout Voltage:  $V_{\text{D}}=165\text{mV}$  at 150mA
- High Precision Output Voltage:  $\pm 1\%$
- Output Noise:  $45\mu\text{Vrms}$  at 80Hz-100KHz
- Good Ripple Rejection Ability: 75dB at 100Hz and  $I_{\text{OUT}}=100\mu\text{A}$
- Tight Load and Line Regulation
- Low Temperature Coefficient
- Over Current Protection
- Thermal Protection
- Reverse-battery Protection
- Zero Off-mode Current
- Logic-controlled Enable

**Applications**

- Cellular Phones
- Cordless Phones
- Digital Still Cameras
- Wireless Communicators
- PDAs / Palmtops
- PC Mother Board
- Consumer Electronics

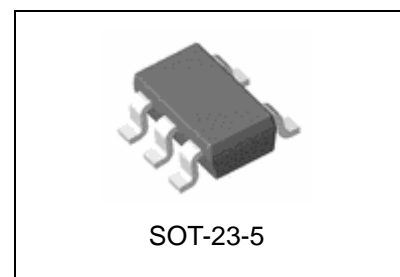

Figure 2. Package Type of AP2201

**150mA RF ULDO REGULATOR****AP2201****Pin Configuration**

Figure 3. Pin Configuration of AP2201 (Top View)

**Pin Description**

Pin Number	Pin Name	Function
1	EN	Logic high enable input.
2	GND	Ground.
3	BYP	Bypass capacitor for low noise operation.
4	$V_{OUT}$	Regulated output voltage.
5	$V_{IN}$	Input voltage.

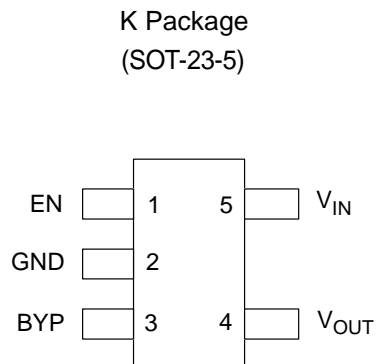

**150mA RF ULDO REGULATOR**

**AP2201**

**Functional Block Diagram**

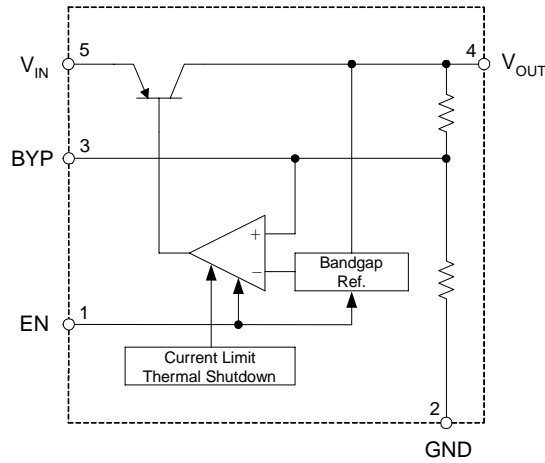
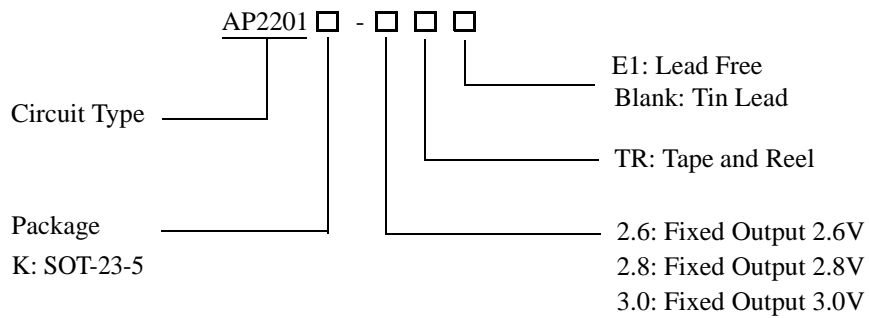

Figure 4. Functional Block Diagram of AP2201

**Ordering Information**



**150mA RF ULDO REGULATOR****AP2201****Ordering Information (Continued)**

Package	Temperature Range	Part Number		Marking ID		Packing Type
		Tin Lead	Lead Free	Tin Lead	Lead Free	
SOT-23-5	-40 to 125°C	AP2201K-2.6TR	AP2201K-2.6TRE1	K1E	E1E	Tape & Reel
		AP2201K-2.8TR	AP2201K-2.8TRE1	K1G	E1G	Tape & Reel
		AP2201K-3.0TR	AP2201K-3.0TRE1	K1I	E1I	Tape & Reel

BCD Semiconductor's Pb-free products, as designated with "E1" suffix in the part number, are RoHS compliant.

**Absolute Maximum Ratings (Note 1)**

Parameter	Symbol	Value	Unit
Supply Input Voltage	$V_{IN}$	15	V
Enable Input Voltage	$V_{EN}$	15	V
Power Dissipation	$P_D$	Internally Limited	W
Lead Temperature (Soldering, 5sec)	$T_{LEAD}$	260	°C
Storage Temperature	$T_{STG}$	-65 to 150	°C
ESD (Machine Model)		200	V
Thermal Resistance	$\theta_{JA}$	(Note 2)	

Note 1: Stresses greater than those listed under "Absolute Maximum Ratings" may cause permanent damage to the device. These are stress ratings only, and functional operation of the device at these or any other conditions beyond those indicated under "Recommended Operating Conditions" is not implied. Exposure to "Absolute Maximum Ratings" for extended periods may affect device reliability.

Note 2: Absolute maximum ratings indicate limits beyond which damage to the component may occur. Electrical specifications do not apply when operating the device outside of its operating ratings. The maximum allowable power dissipation is a function of the maximum junction temperature,  $T_{J(max)}$ , the junction-to-ambient thermal resistance,  $\theta_{JA}$ , and the ambient temperature,  $T_A$ . The maximum allowable power dissipation at any ambient temperature is calculated using:  $P_{D(max)} = (T_{J(max)} - T_A) / \theta_{JA}$ . Exceeding the maximum allowable power dissipation will result in excessive die temperature, and the regulator will go into thermal shutdown.

**Recommended Operating Conditions**

Parameter	Symbol	Min	Max	Unit
Supply Input Voltage	$V_{IN}$	2.5	13.2	V
Enable Input Voltage	$V_{EN}$	0	13.2	V
Operating Junction Temperature	$T_J$	-40	125	°C



**150mA RF ULDO REGULATOR**

**AP2201**

**Electrical Characteristics**

$V_{IN}=V_{OUT}+1V$ ,  $I_{OUT} = 100\mu A$ ,  $C_L = 2.2\mu F$ ,  $V_{EN} \geq 2.0V$ ,  $T_J = 25^\circ C$ , **Bold** typeface applies over  $-40^\circ C < T_J < 125^\circ C$ , unless otherwise specified.

Parameter	Symbol	Conditions	Min	Typ	Max	Unit	
Output Voltage Accuracy	$\Delta V_O/V_O$	Variation from specified $V_{OUT}$	-1		1	%	
			-2		2		
Output Voltage Temperature Coefficient	$\Delta V_O/\Delta T$	(Note 3)		<b>120</b>		$\mu V/^\circ C$	
Line Regulation	$V_{RLINE}$	AP2201-2.6V $V_{IN}=V_{OUT}+1V$ to 13.2V		1	3	mV	
					<b>13</b>		
		AP2201-2.8V $V_{IN}=V_{OUT}+1V$ to 13.2V		1	4		<b>14</b>
		AP2201-3.0V $V_{IN}=V_{OUT}+1V$ to 13.2V		1	4	<b>14</b>	
Load Regulation (Note 4)	$V_{RLOAD}$	AP2201-2.6V $I_{OUT}=0.1mA$ to 150mA		1	8	mV	
					<b>16</b>		
		AP2201-2.8V $I_{OUT}=0.1mA$ to 150mA		1	9		<b>18</b>
		AP2201-3.0V $I_{OUT}=0.1mA$ to 150mA		1	9	<b>18</b>	
Dropout Voltage (Note 5)	$V_{IN}-V_O$	$I_{OUT}=100\mu A$		15	50	mV	
					<b>70</b>		
		$I_{OUT}=50mA$		110	150		<b>230</b>
					<b>300</b>		
		$I_{OUT}=100mA$		140	250	<b>300</b>	
		$I_{OUT}=150mA$		165	275	<b>350</b>	
Quiescent Current	$I_Q$	$V_{EN} \leq 0.4V$ (shutdown)		0.01	1	$\mu A$	
		$V_{EN} \leq 0.18V$ (shutdown)			<b>5</b>		
Ground Pin Current (Note 6)	$I_{GND}$	$V_{EN} \geq 2.0V$ , $I_{OUT}=0\mu A$		180	245	$\mu A$	
					<b>265</b>		
		$V_{EN} \geq 2.0V$ , $I_{OUT}=100\mu A$		182	250		<b>270</b>
					<b>270</b>		
		$V_{EN} \geq 2.0V$ , $I_{OUT}=50mA$		350	600	<b>800</b>	
		$V_{EN} \geq 2.0V$ , $I_{OUT}=100mA$		600	1000	<b>1500</b>	



**150mA RF ULDO REGULATOR**

**AP2201**

**Electrical Characteristics (Continued)**

$V_{IN}=V_{OUT}+1V$ ,  $I_{OUT} = 100\mu A$ ,  $C_L = 2.2\mu F$ ,  $V_{EN} \geq 2.0V$ ,  $T_J = 25^\circ C$ , **Bold** typeface applies over  $-40^\circ C < T_J < 125^\circ C$ , unless otherwise specified.

Parameter	Symbol	Conditions	Min	Typ	Max	Unit
Ground Pin Current (Note 6)	$I_{GND}$	$V_{EN} \geq 2.0V$ , $I_{OUT}=150mA$		1300	1900	$\mu A$
					<b>2500</b>	
Ripple Rejection	PSRR	frequency=100Hz, $I_{OUT}=100\mu A$		75		dB
Current Limit	$I_{LIMIT}$	$V_{OUT} = 0V$		<b>320</b>	550	mA
Output Noise (Regulator B only)	$e_{no}$	$I_{OUT}=50mA$ , $C_L=2.2\mu F$ , 470 pF from BYP to GND		260		$nV/\sqrt{Hz}$
Enable Input Logic-Low Voltage	$V_{IL}$	Regulator shutdown			0.4	V
					<b>0.18</b>	
Enable Input Logic-High Voltage	$V_{IH}$	Regulator enabled	<b>2.0</b>			V
Enable Input Logic-Low Current	$I_{IL}$	$V_{IL} \leq 0.4V$		0.01	-1	$\mu A$
		$V_{IL} \leq 0.18V$			<b>-2</b>	
Enable Input Logic-High Current	$I_{IH}$	$V_{IL} \geq 2.0V$		5	20	$\mu A$
		$V_{IL} \geq 2.0V$			<b>25</b>	

Note 3: Output voltage temperature coefficient is defined as the worst case voltage change divided by the total temperature range.

Note 4: Regulation is measured at constant junction temperature using low duty cycle pulse testing. Parts are tested for load regulation in the load range from 0.1mA to 150mA. Changes in output voltage due to heating effects are covered by the thermal regulation specification.

Note 5: Dropout voltage is defined as the input to output differential at which the output voltage drops 2% below its nominal value measured at 1V differential.

Note 6: Ground pin current is the regulator quiescent current plus pass transistor base current. The total current drawn from the supply is the sum of the load current plus the ground pin current.



**150mA RF ULDO REGULATOR**

**AP2201**

**Typical Performance Characteristics**

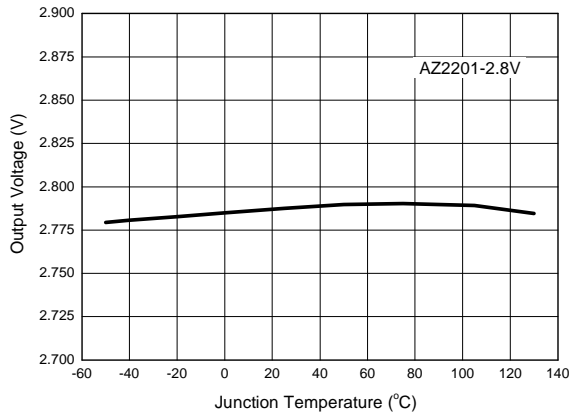

Figure 5. Output Voltage vs. Junction Temperature

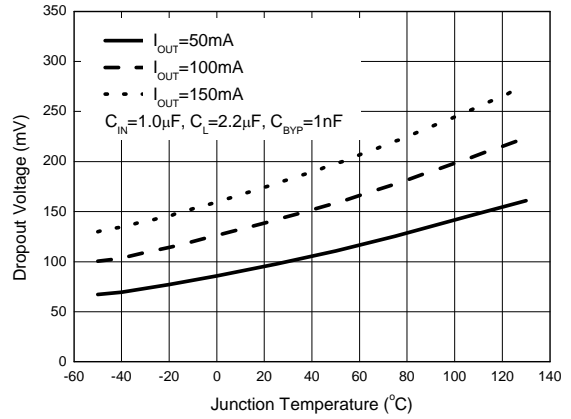

Figure 6. Dropout Voltage vs. Junction Temperature

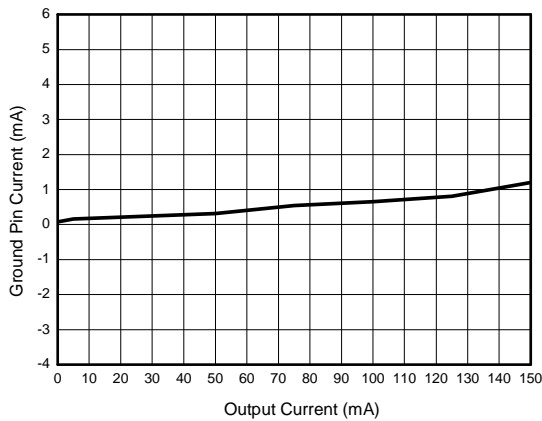

Figure 7. Ground Pin Current vs. Output Current

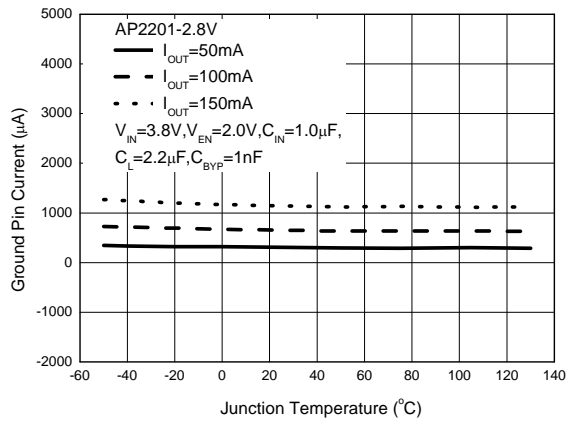

Figure 8. Ground Pin Current vs. Junction Temperature



**150mA RF ULDO REGULATOR**

**AP2201**

**Typical Performance Characteristics (Continued)**

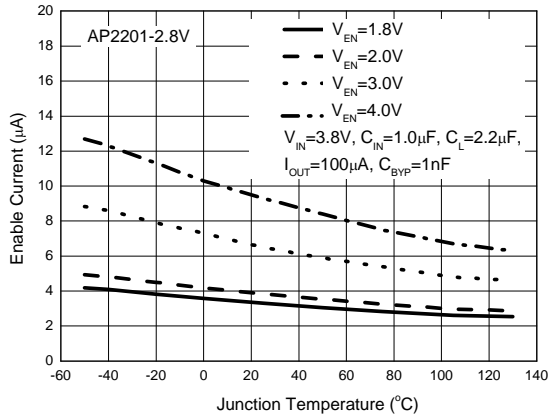

Figure 9. Enable Current vs. Junction Temperature

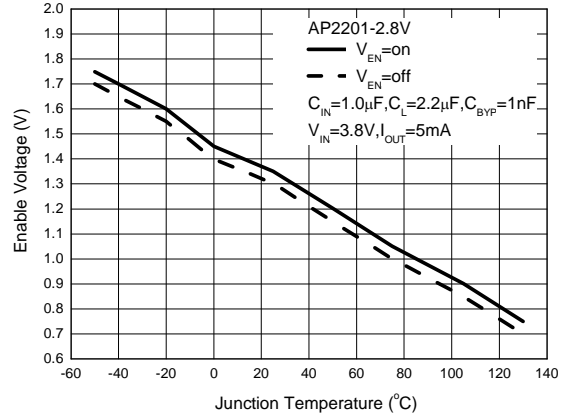

Figure 10. Enable Voltage vs. Junction Temperature

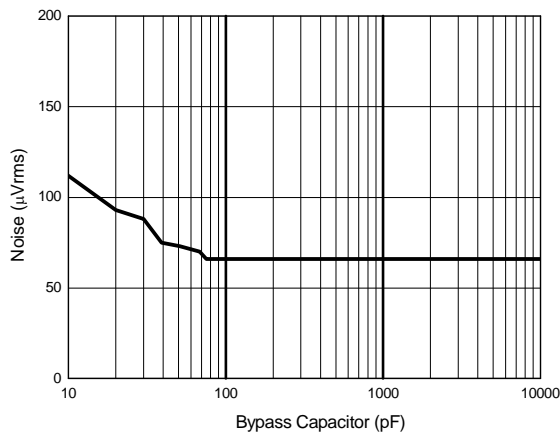

Figure 11. Noise vs. Bypass Capacitor

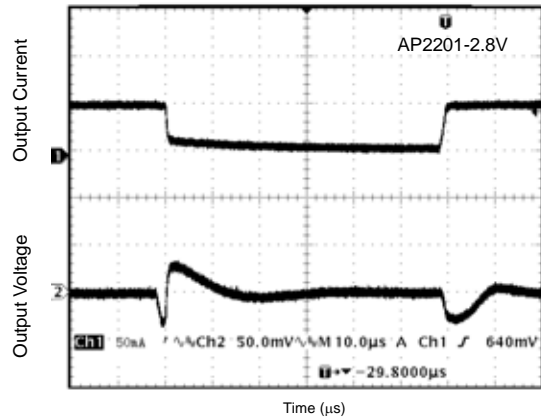

Figure 12. Load Transient  
(Conditions:  $V_{IN}=3.8V$ ,  $C_{BYP}=680pF$ ,  $V_{EN}=2V$ ,  $I_{OUT}=5mA$  to  $50mA$ ,  $C_L=2.2µF$ )





**150mA RF ULDO REGULATOR**

**AP2201**

**Typical Performance Characteristics (Continued)**

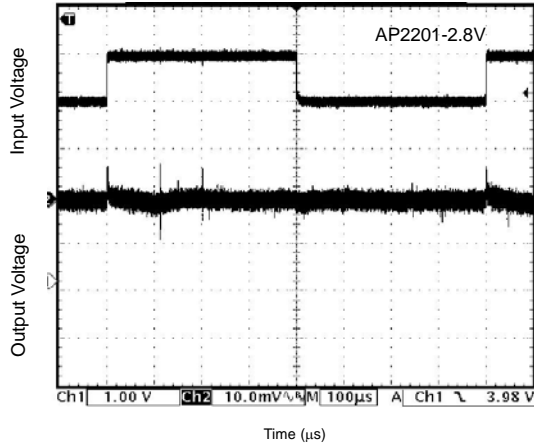

Figure 13. Line Transient  
 (Conditions:  $V_{IN}=3.8V$  to  $4.8V$ ,  $V_{EN}=2V$ ,  $I_{OUT}=100\mu A$ ,  $C_{BYP}=680pF$ ,  $C_L=10\mu F$ )

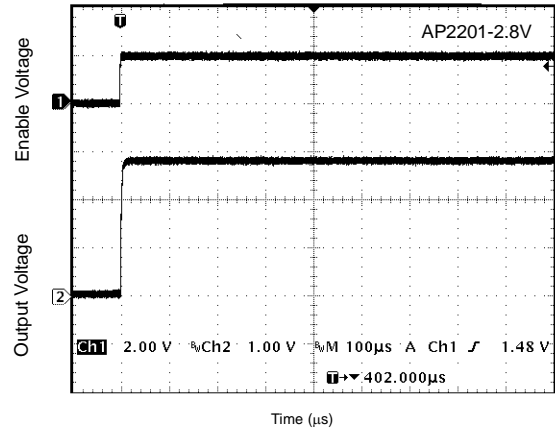

Figure 14.  $V_{EN(on)}$  vs.  $V_O$   
 (Conditions:  $V_{EN}=0V$  to  $2V$ ,  $V_{IN}=3.8V$ ,  $I_{OUT}=30mA$ ,  $C_{BYP}=open$ ,  $C_L=2.2\mu F$ )

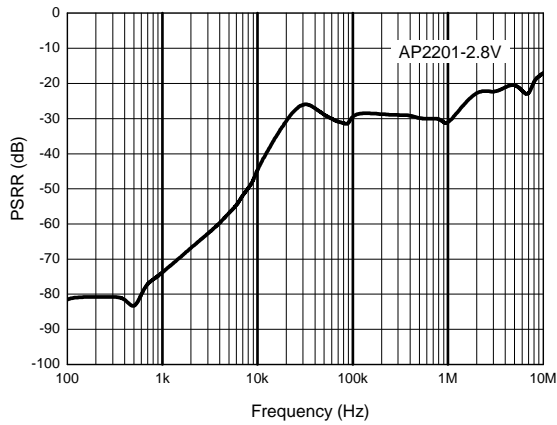

Figure 15. PSRR vs. Frequency  
 ( Conditions:  $C_{IN}=1.0\mu F$ ,  $C_L=2.2\mu F$ ,  $C_{BYP}=open$ ,  $V_{IN}=3.8V$ ,  $I_{OUT}=10mA$ ,  $V_{EN}=2V$ )

**150mA RF ULDO REGULATOR****AP2201****Application Information****External Capacitors**

The AP2201 requires external capacitors for regulator stability. These capacitors must be correctly selected for good performance.

**Input Capacitor**

If there is more than 10 inches of wire between the input and the AC filter or if a battery is used as the input, at least a  $1\mu\text{F}$  capacitor should be placed from IN to GND.

**Output Capacitor**

It is required to prevent oscillation.  $1.0\mu\text{F}$  minimum is recommended when  $C_{\text{BYP}}$  is not used.  $2.2\mu\text{F}$  minimum is recommended when  $C_{\text{BYP}}$  is  $470\text{pF}$ . The output capacitor may be increased without limit for large values to improve transient response.

The output capacitor should have an ESR of about  $5\Omega$  or less. In most cases, tantalum or aluminium electrolytic capacitors are adequate.

**Noise Bypass Capacitor**

Bypass capacitor is connected to the internal voltage reference. A  $680\text{pF}$  capacitor connected from BYP to GND make this reference quiet, resulting in a significant reduction in output noise. When using  $C_{\text{BYP}}$  output capacitors of  $2.2\mu\text{F}$  or greater are required for better stability.

The start-up speed of the AP2201 is inversely proportional to the value of reference bypass capacitor. In some cases if output noise is not a major concern and rapid turn-on is necessary, omit  $C_{\text{BYP}}$  and leave BYP open.



**150mA RF ULDO REGULATOR**

**AP2201**

**Mechanical Dimensions**

**SOT-23-5**

**Unit: mm(inch)**

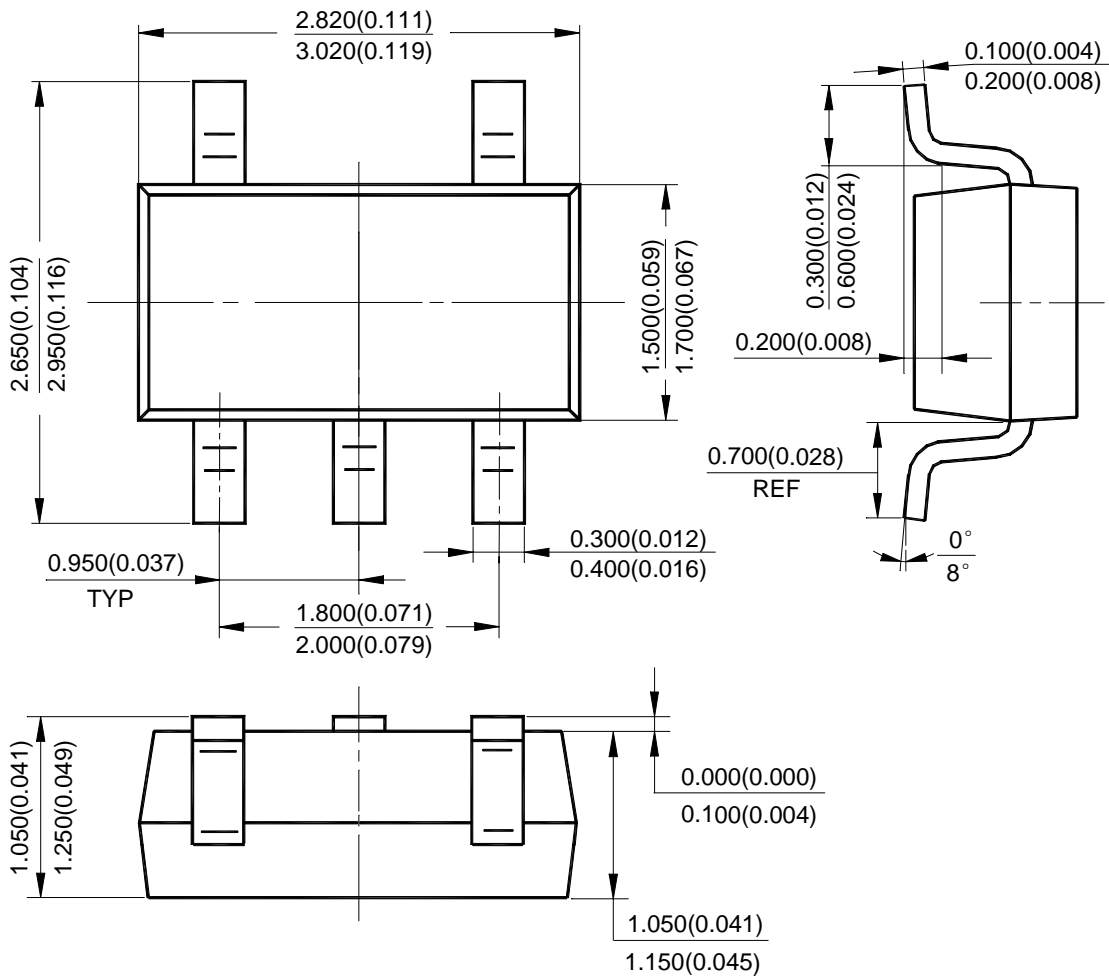



BCD Semiconductor Manufacturing Limited

<http://www.bcdsemi.com>

---

**BCD Semiconductor Corporation**

3170 De La Cruz Blvd, Suite # 105 Santa Clara, CA 95054-2411, U.S.A

Tel: +1-408-988 6388, Fax: +1-408-988 6386

**Shanghai SIM-BCD Semiconductor Manufacturing Co., Ltd.**

800 Yi Shan Road, Shanghai 200233, PRC

Tel: +86-21-6485 1491, Fax: +86-21-5450 0008

**Advanced Analog Circuits (Shanghai) Corporation**

8F, B Zone, 900 Yi Shan Road, Shanghai 200233, PRC

Tel: +86-21-6495 9539, Fax: +86-21-6485 9673

**BCD Semiconductor (Taiwan) Company Limited**

4F, 298-1 Rui Guang Road, Nei-Hu District, Taipei, Taiwan

Tel: +886-2-2656-2808, Fax: +886-2-2656-2806

**IMPORTANT NOTICE**

BCD Semiconductor Manufacturing Limited reserves the right to make changes without further notice to any products or specifications herein. BCD Semiconductor Manufacturing Limited does not assume any responsibility for use of any its products for any particular purpose, nor does BCD Semiconductor Manufacturing Limited assume any liability arising out of the application or use of any its products or circuits. BCD Semiconductor Manufacturing Limited does not convey any license under its patent rights or other rights nor the rights of others.