

Description

The AP2204 series is a positive voltage regulator IC fabricated by high voltage EPNP process.

The AP2204 has features of wide input voltage range, high accuracy, high ripple rejection, low dropout voltage, low noise, current limit and ultra-low quiescent current which make it ideal for use in various USB and portable devices.

The IC consists of a voltage reference, an error amplifier, a resistor network for setting output voltage, a current limit circuit for current protection, and a chip enable circuit.

The AP2204 has 1.5V, 1.8V, 2.5V, 2.8V, 3.0V, 3.3V, 5.0V fixed voltage versions and adjustable voltage version.

The AP2204 is available in space-saving SOT-23-5, SOT-89 and PSOP-8 packages.

Features

- Wide Input Voltage Range: 2.6V to 24V
- Wide Output Voltage Range: 1.24V to 22V
- Excellent Ripple Rejection: 60dB@ f = 1kHz
- Low Dropout Voltage: $V_{DROD} = 100mV @ I_{OUT} = 100\mu A$
- Low Ground Current
- High Output Voltage Accuracy
- Compatible with Low ESR Ceramic Capacitor
- Excellent Line/Load Regulation
- Thermal Shutdown Function
- **Totally Lead-Free & Fully RoHS Compliant (Notes 1 & 2)**
- **Halogen and Antimony Free. "Green" Device (Note 3)**
- **For automotive applications requiring specific change control (i.e. parts qualified to AEC-Q100/101/200, PPAP capable, and manufactured in IATF 16949 certified facilities), please [contact us](#) or your local Diodes representative. <https://www.diodes.com/quality/product-definitions/>**

Applications

- Battery-powered Equipment
- Laptop, Palmtops, Notebook Computers
- Portable Information Appliances

- Notes:
1. No purposely added lead. Fully EU Directive 2002/95/EC (RoHS), 2011/65/EU (RoHS 2) & 2015/863/EU (RoHS 3) compliant.
 2. See <https://www.diodes.com/quality/lead-free/> for more information about Diodes Incorporated's definitions of Halogen- and Antimony-free, "Green" and Lead-free.
 3. Halogen- and Antimony-free "Green" products are defined as those which contain <900ppm bromine, <900ppm chlorine (<1500ppm total Br + Cl) and <1000ppm antimony compounds.

Pin Assignments

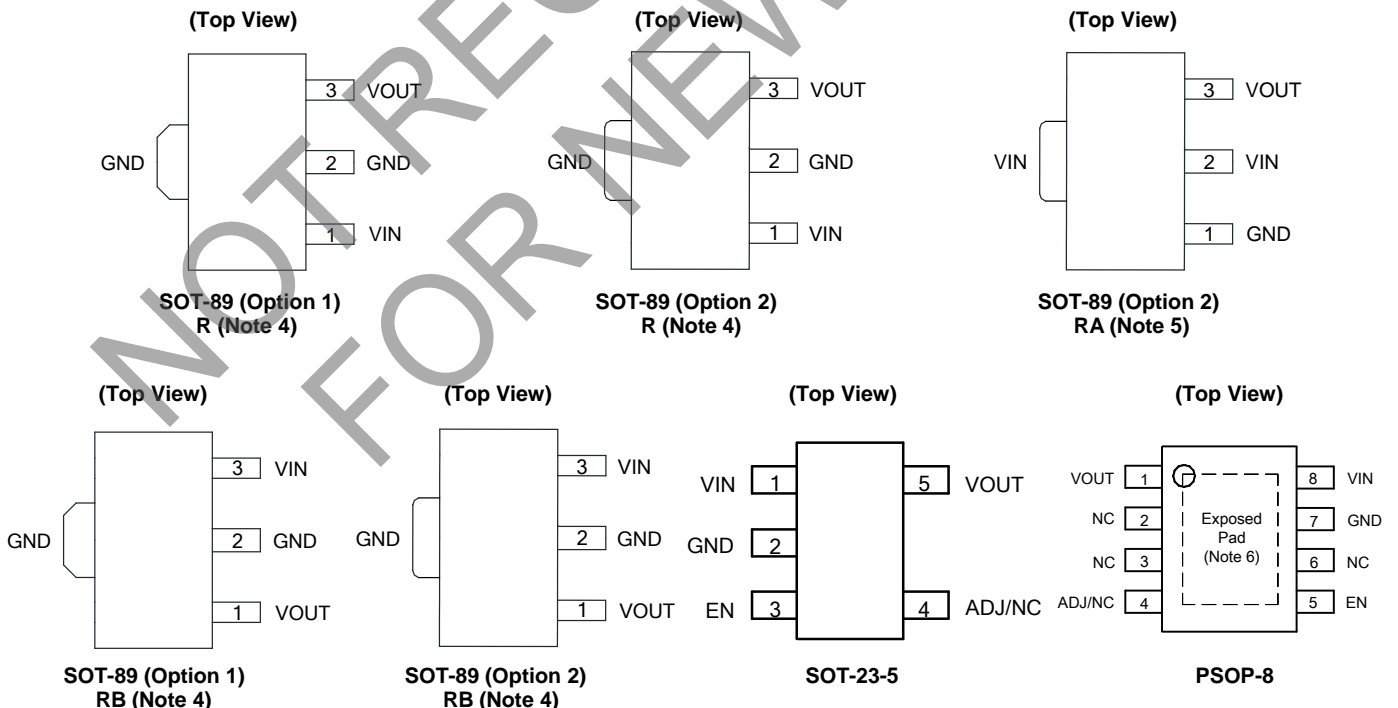

- Notes:
4. The substrate/exposed pad should be connected to GND.
 5. The substrate/exposed pad should be connected to VIN.
 6. The exposed pad should be connected to GND for better dissipation.

Typical Applications Circuit

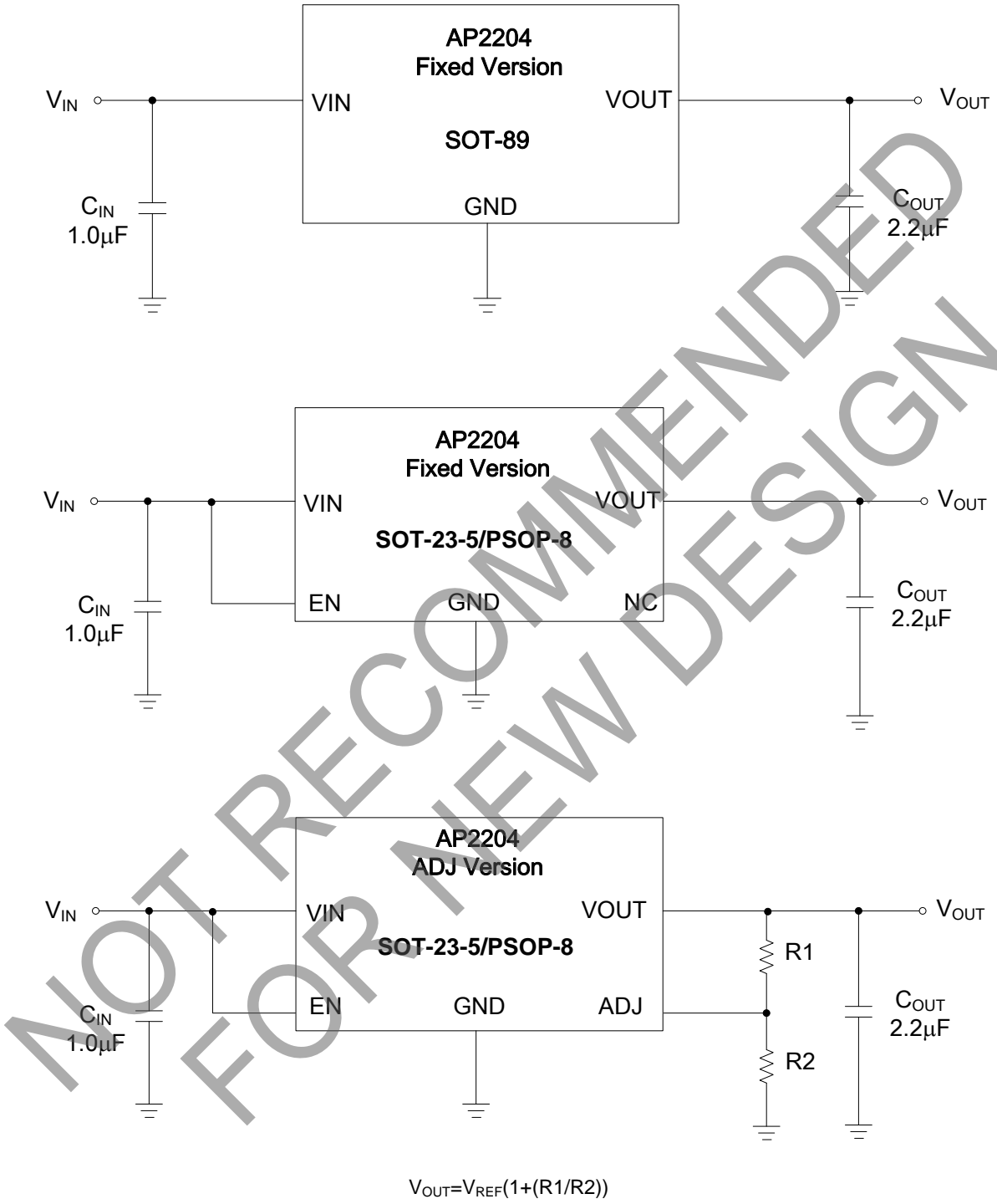

Pin Descriptions

Pin Number					Pin Name	Function
SOT-23-5	PSOP-8	SOT-89				
		R	RA	RB		
1	8	1	2	3	VIN	Input voltage
2	7	2	1	2	GND	Ground
3	5	—	—	—	EN	Enable input
4	4	—	—	—	ADJ/NC	ADJ- Adjust output for ADJ version NC- Not connected for fixed version, Not Connected internally. Recommend connection to GND to maximize PCB copper for thermal dissipation.
5	1	3	3	1	VOUT	Regulated output voltage

Functional Block Diagram

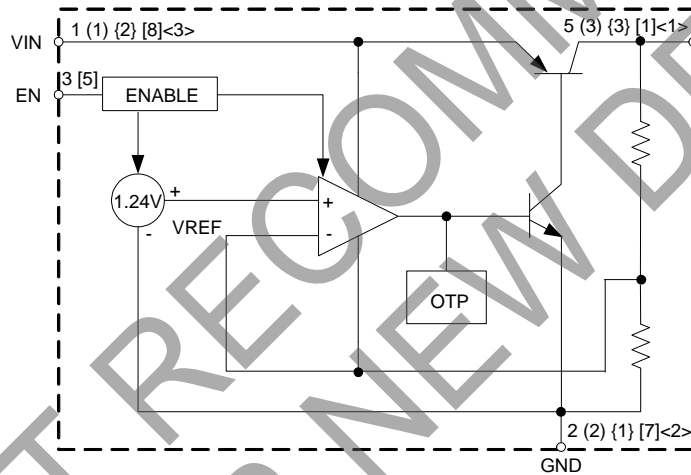

Fixed Output Voltage

A (B) {C} [D] <E>
 A for SOT-23-5
 B for SOT-89 (R)
 C for SOT-89 (RA)
 D for PSOP-8
 E for SOT-89 (RB)

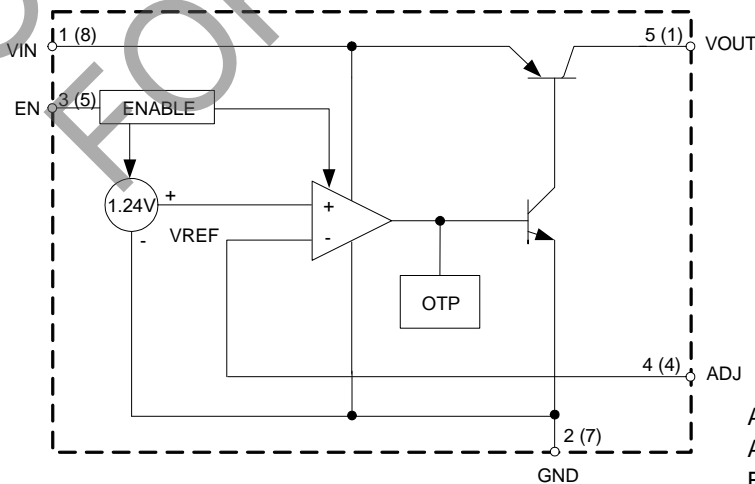

Adjustable Output Voltage

A (B)
 A for SOT-23-5
 B for PSOP-8

Absolute Maximum Ratings (Note 7)

Symbol	Parameter	Rating		Unit
V_{IN}	Supply Input Voltage	38		V
V_{CE}	Enable Input Voltage	38		V
I_{OUT}	Output Current	250		mA
T_{LEAD}	Lead Temperature (Soldering, 10sec)	+260		°C
T_J	Operating Junction Temperature	+150		°C
θ_{JA}	Thermal Resistance	SOT-23-5	250	°C/W
		SOT-89	165	
		PSOP-8 (Note 8)	51	
T_{STG}	Storage Temperature Range	-65 to +150		°C
—	ESD (Machine Model)	275		V
—	ESD (Human Body Model)	2000		V

Notes: 7. Stresses greater than those listed under "Absolute Maximum Ratings" can cause permanent damage to the device. These are stress ratings only, and functional operation of the device at these or any other conditions beyond those indicated under "Recommended Operating Conditions" is not implied. Exposure to "Absolute Maximum Ratings" for extended periods can affect device reliability.
 8. θ_{JA} is measured with the component mounted on a 2-Layer FR-4 PCB board with 1.5cm*1.5cm thermal sink pad in free air.

Recommended Operating Conditions

Symbol	Parameter	Min	Max	Unit
V_{IN}	Supply Input Voltage	2.6 (Note 9)	24	V
T_J	Operating Junction Temperature	-40	+125	°C

Note: 9. Minimum recommended input voltage is the larger of 2.6V or $V_{OUT} + 1V$. Below this value the device may enter drop-out conditions and cease to regulate the output voltage correctly.

Electrical Characteristics (@ $V_{IN} = V_{OUT} + 1V$, $T_J = +25^\circ C$, $I_{OUT} = 100\mu A$, $C_{IN} = 1.0\mu F$, $C_{OUT} = 2.2\mu F$, **Bold** typeface applies over $-40^\circ C \leq T_J \leq +125^\circ C$, unless otherwise specified.)

Symbol	Parameter	Conditions	Min	Typ	Max	Unit	
V_{OUT}	Output Voltage	Variation from Specified V_{OUT}	$V_{OUT} \times 98\%$	—	$V_{OUT} \times 102\%$	V	
V_{REF}	Reference Voltage	—	1.215	1.24	1.265	V	
V_{IN}	Input Voltage	—	—	—	24	V	
$I_{OUT(max)}$	Maximum Output Current	$V_{IN} - V_{OUT} = 1V$, $V_{OUT} = 98\% \times V_{OUT}$	150	200	—	mA	
$\Delta V_{OUT}/\Delta V_{IN}$	Line Regulation	$V_{OUT} + 1V \leq V_{IN} \leq 24V$	—	0.05	—	%	
$\Delta V_{OUT}/V_{OUT}$	Load Regulation	$1mA \leq I_{OUT} \leq 150mA$	—	0.5	—	%	
V_{DROP}	Dropout Voltage	$I_{OUT} = 100\mu A$	—	100	150	mV	
		$I_{OUT} = 50mA$	—	270	350		
		$I_{OUT} = 100mA$	—	320	460		
		$I_{OUT} = 150mA$	—	360	500		
I_{GND}	Ground Current	$I_{OUT} = 0A$	—	20	—	μA	
		$I_{OUT} = 100\mu A$	—	50	—	mA	
		$I_{OUT} = 50mA$	—	0.5	—		
		$I_{OUT} = 100mA$	—	1.3	—		
		$I_{OUT} = 150mA$	—	2.5	—		
I_{STD}	Standby Current	$V_{IN} = V_{OUT} + 1V$ V_{EN} in OFF Mode	—	0.01	1.0	μA	
PSRR	Power Supply Rejection Ratio	Ripple 0.5V _{P-P} $V_{IN} = V_{OUT} + 1V$	f = 100Hz	—	60	—	dB
			f = 1kHz	—	60	—	
$\Delta V_{OUT}/(V_{OUT} \times \Delta T)$	Output Voltage Temperature Coefficient	$I_{OUT} = 100\mu A$, $-40^\circ C \leq T_J \leq +125^\circ C$	—	± 100	—	ppm/ $^\circ C$	
V_{NOI}	RMS Output Noise	$T_J = +25^\circ C$, $10Hz \leq f \leq 100kHz$	—	30	—	μV_{rms}	
I_{ADJ}	ADJ Pin Current	$I_{OUT} = 100\mu A$	—	0.5	—	μA	
I_{EN}	EN Pin Current	$V_{EN} = V_{OUT} + 1V$	—	1	—	μA	
—	EN "High" Voltage	EN Input Voltage "High"	2.0	—	—	V	
—	EN "Low" Voltage	EN Input Voltage "Low"	—	—	0.4	V	
θ_{JC}	Thermal Resistance (Junction to Case)	SOT-23-5	—	43	—	$^\circ C/W$	
		SOT-89	—	27	—		
		PSOP-8	—	22	—		

Performance Characteristics

Output Voltage vs. Output Current

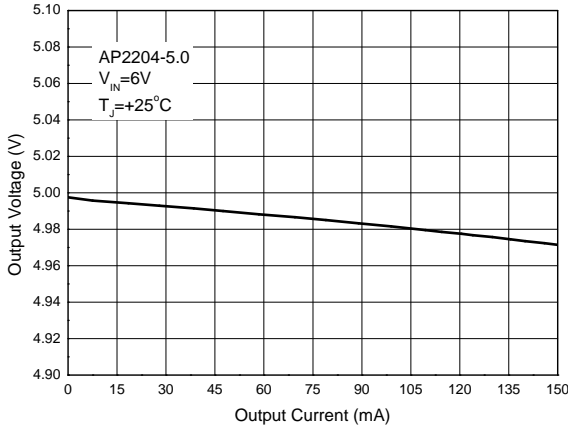

Output Voltage vs. Output Current

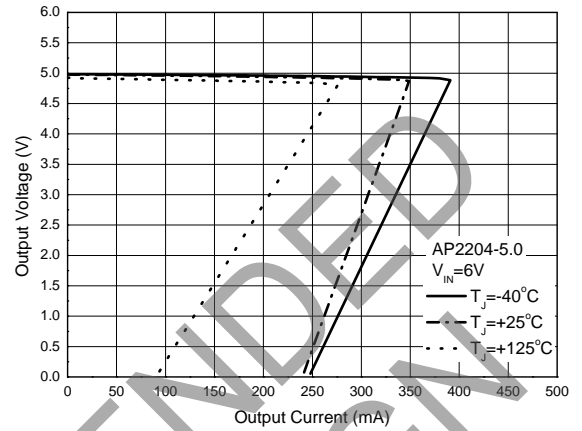

Output Voltage vs. Output Current

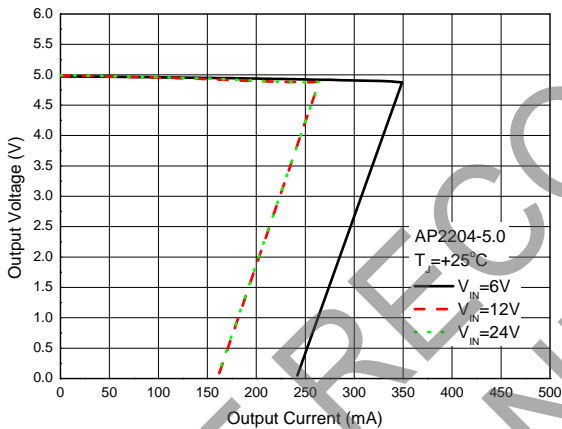

Dropout Voltage vs. Output Current

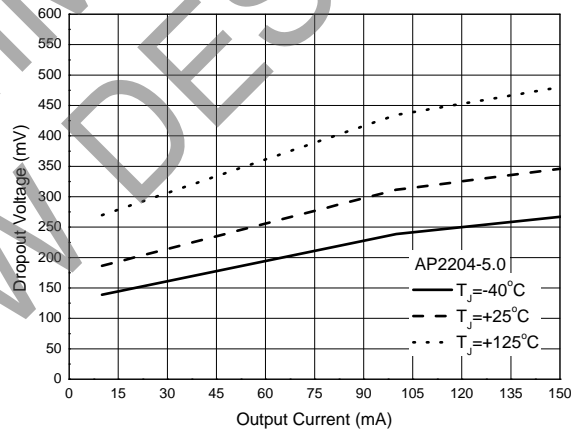

Dropout Voltage vs. Junction Temperature

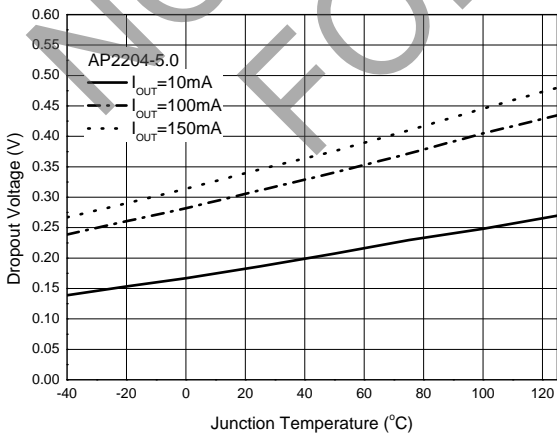

Output Voltage vs. Input Voltage

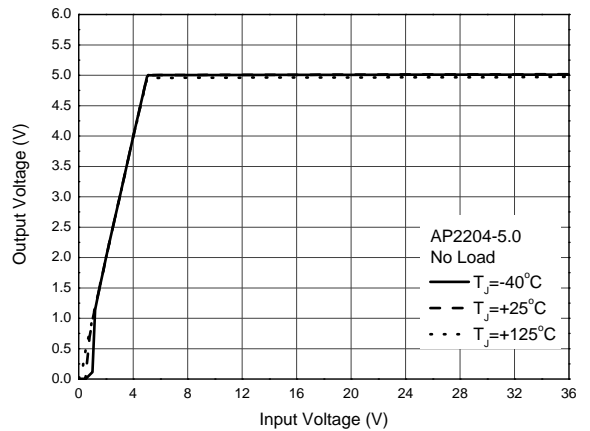

Performance Characteristics (continued)

Output Voltage vs. Input Voltage

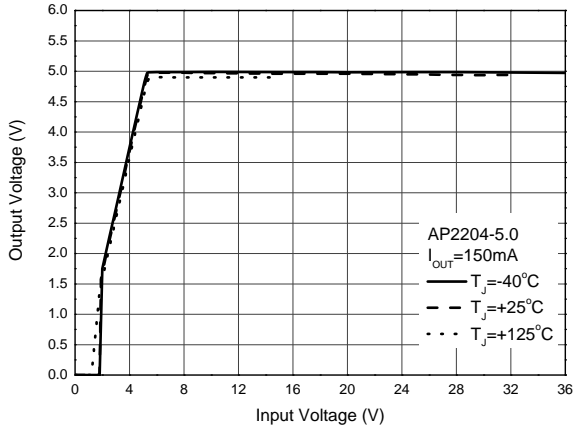

Output Voltage vs. Junction Temperature

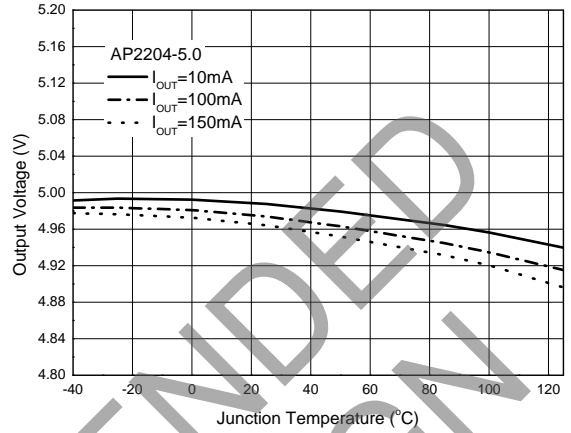

Supply Current vs. Input Voltage

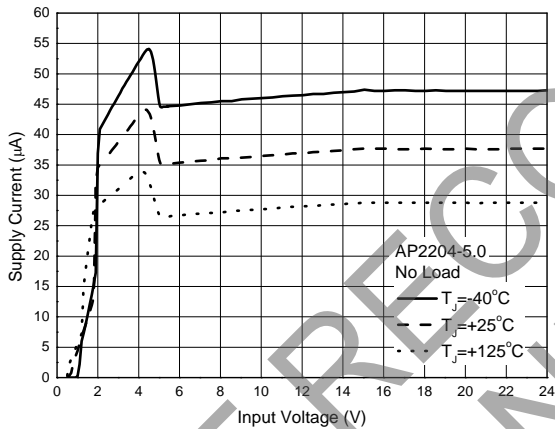

Ground Current vs. Junction Temperature

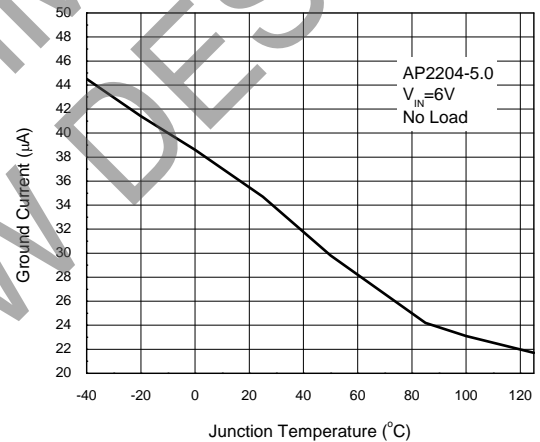

Ground Current vs. Output Current

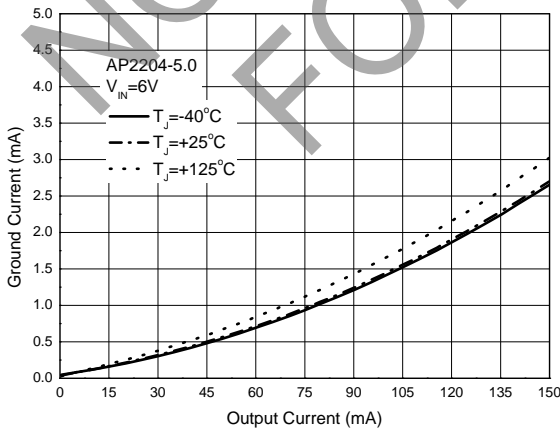

Enable Current vs. Enable Input Voltage

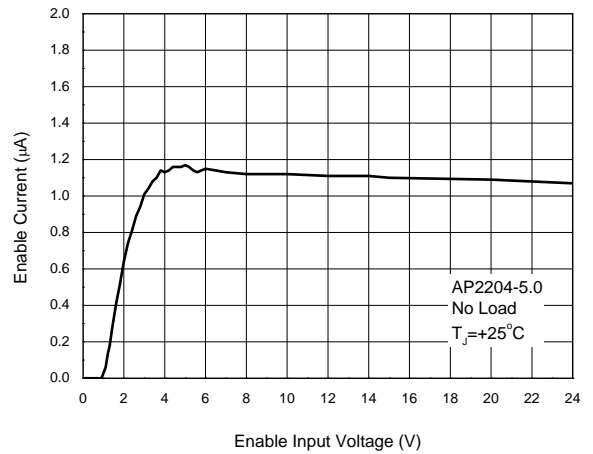

Performance Characteristics (continued)

Line Transient
(Conditions: $V_{IN}=V_{EN}=3.5V$ to $8V$, $C_{IN}=1.0\mu F$,
 $C_{OUT}=2.2\mu F$, $I_{OUT}=1mA$)

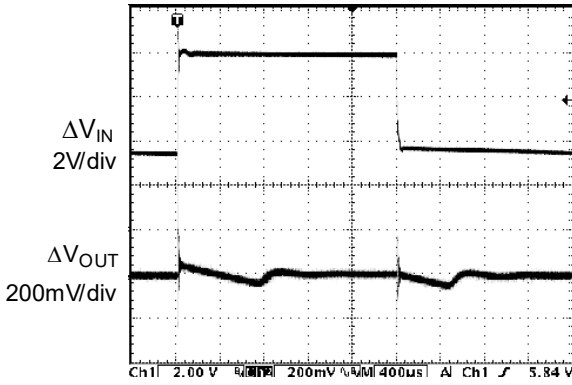

Line Transient
(Conditions: $V_{IN}=V_{EN}=5V$ to $15V$, $C_{IN}=1.0\mu F$,
 $C_{OUT}=2.2\mu F$, $I_{OUT}=1mA$)

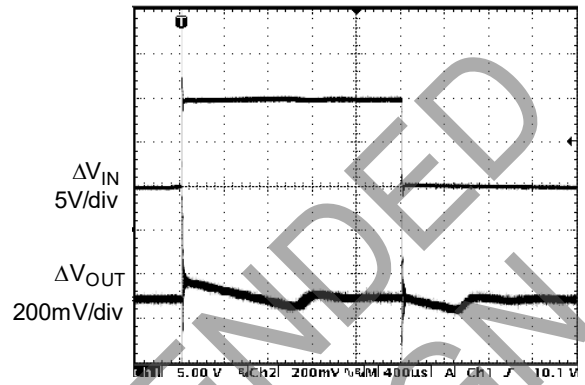

Load Transient
(Conditions: $V_{IN}=5V$, $C_{IN}=1.0\mu F$, $C_{OUT}=2.2\mu F$,
 $I_{OUT}=1mA$ to $50mA$)

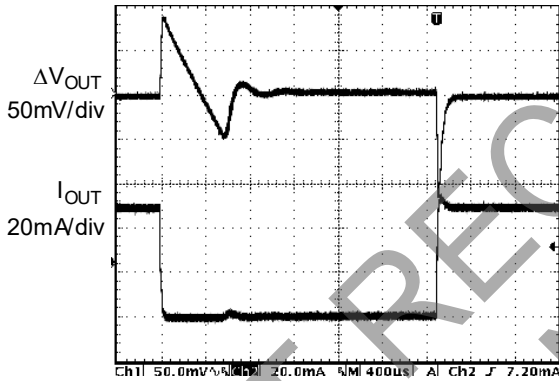

Load Transient
(Conditions: $V_{IN}=5V$, $C_{IN}=1.0\mu F$, $C_{OUT}=2.2\mu F$,
 $I_{OUT}=1mA$ to $150mA$)

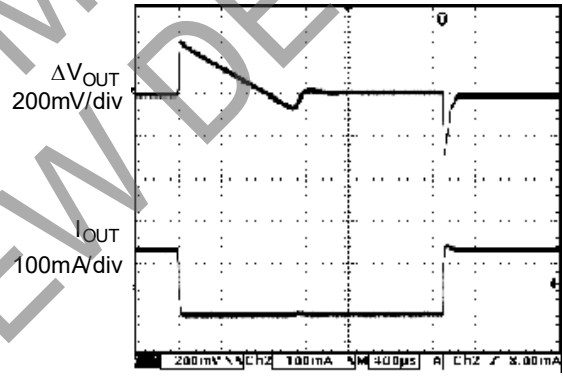

Enable Input Response



Start-up Response

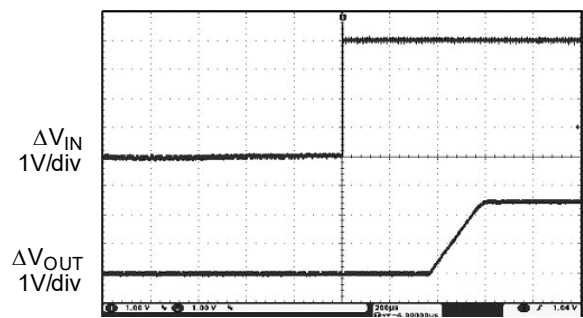

Performance Characteristics (continued)

PSRR vs. Frequency
(Conditions: $V_{PP}=2V$, $I_{OUT}=10mA$)

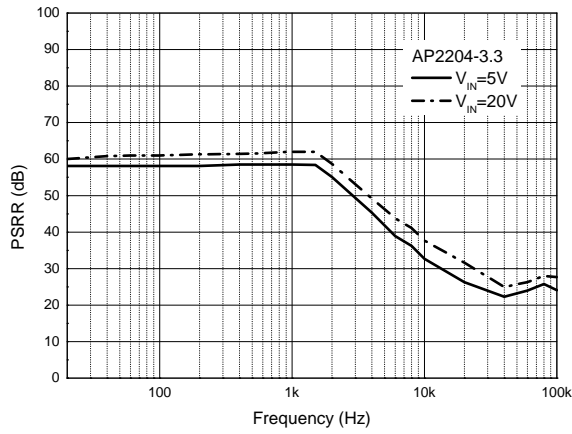

Output Voltage vs. Output Current

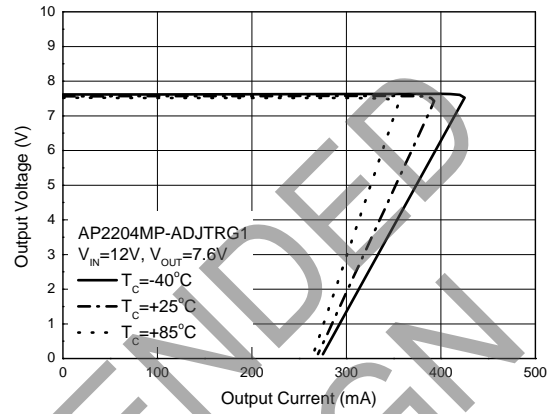

Maximum Output Current vs. Case Temperature

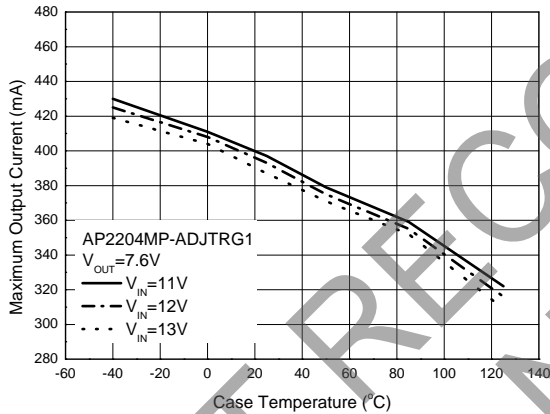

Case Temperature vs. Output Current

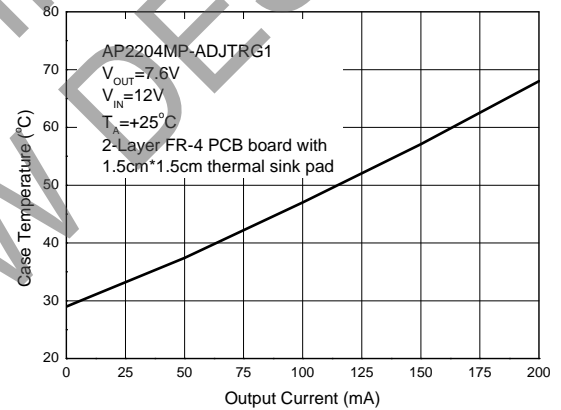

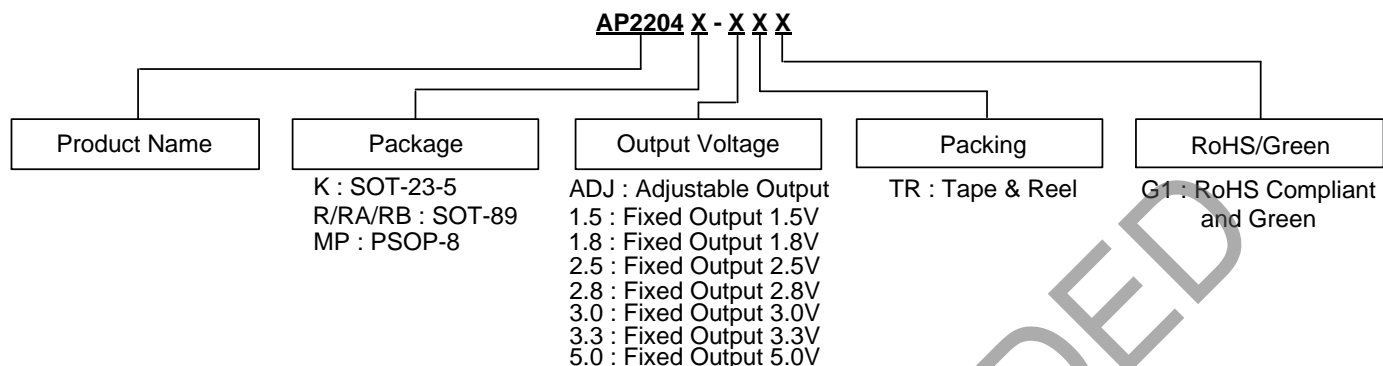
Ordering Information



Package	Temperature Range	Output Voltage	Part Number	Marking ID	Packing
SOT-23-5	-40 to +85°C	ADJ	AP2204K-ADJTRG1	GAF	3000/7" Tape & Reel
		1.5V	AP2204K-1.5TRG1	GBH	3000/7" Tape & Reel
		1.8V	AP2204K-1.8TRG1	GAG	3000/7" Tape & Reel
		2.5V	AP2204K-2.5TRG1	GAD	3000/7" Tape & Reel
		2.8V	AP2204K-2.8TRG1	GAE	3000/7" Tape & Reel
		3.0V	AP2204K-3.0TRG1	GEF	3000/7" Tape & Reel
		3.3V	AP2204K-3.3TRG1	GAH	3000/7" Tape & Reel
		5.0V	AP2204K-5.0TRG1	GAI	3000/7" Tape & Reel
SOT-89	-40 to +85°C	1.5V (R)	AP2204R-1.5TRG1	G22C	1000/7" Tape & Reel
		1.8V (R)	AP2204R-1.8TRG1	G31C	1000/7" Tape & Reel
		2.5V (R)	AP2204R-2.5TRG1	G22D	1000/7" Tape & Reel
		2.8V (R)	AP2204R-2.8TRG1	G22E	1000/7" Tape & Reel
		3.0V (R)	AP2204R-3.0TRG1	G22F	1000/7" Tape & Reel
		3.3V (R)	AP2204R-3.3TRG1	G31D	1000/7" Tape & Reel
		5.0V (R)	AP2204R-5.0TRG1	G31E	1000/7" Tape & Reel
SOT-89	-40 to +85°C	3.3V (RA)	AP2204RA-3.3TRG1	G37O	1000/7" Tape & Reel
		5.0V (RA)	AP2204RA-5.0TRG1	G41O	1000/7" Tape & Reel
SOT-89	-40 to +85°C	3.3V (RB)	AP2204RB-3.3TRG1	G37R	1000/7" Tape & Reel
		5.0V (RB)	AP2204RB-5.0TRG1	G41R	1000/7" Tape & Reel
PSOP-8	-40 to +85°C	ADJ	AP2204MP-ADJTRG1	2204MP-ADJG1	4000/13" Tape & Reel

Marking Information

(1) SOT-23-5

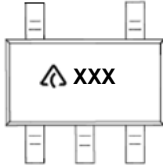
(Top View)



 : Logo
XXX: Marking ID (See Ordering Information)

(2) SOT-89

(Top View)

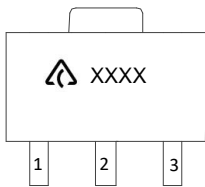

(Top View)

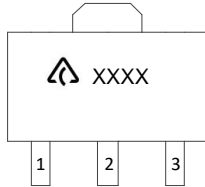

First Line: Logo and Marking ID
(See Ordering Information)

(3) PSOP-8

(Top View)



First and Second Lines: Logo and Marking ID
(See Ordering Information)
Third Line: Date Code
Y: Year
WW: Work Week of Molding
A: Assembly House Code
XX: 7th and 8th Digits of Batch Number

NOT RECOMMENDED FOR NEW DESIGN

Package Outline Dimensions (All dimensions in mm(inch).)

Please see <http://www.diodes.com/package-outlines.html> for the latest version.

(1) Package Type: SOT-23-5

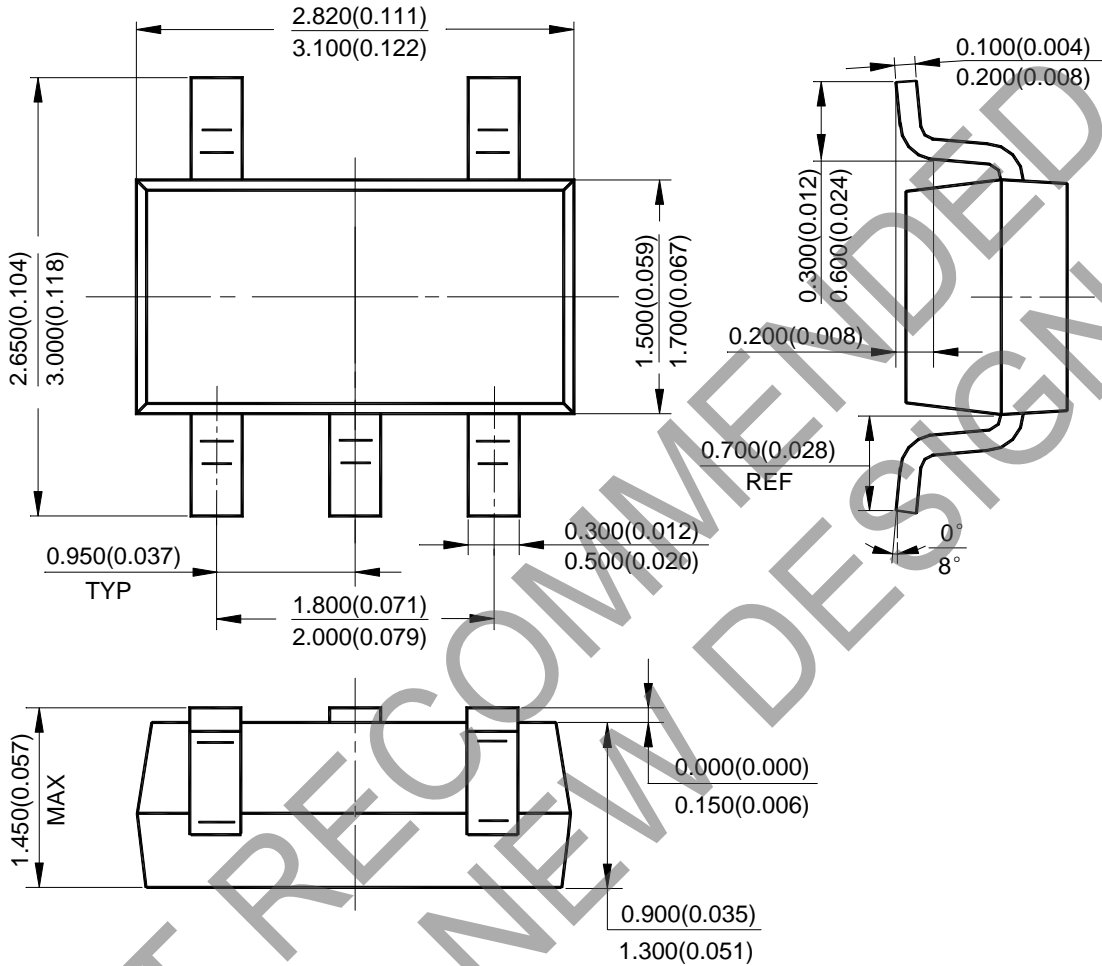

NOT RECOMMENDED FOR NEW DESIGN

Package Outline Dimensions (All dimensions in mm(inch).) (continued)

Please see <http://www.diodes.com/package-outlines.html> for the latest version.

(2) Package Type: SOT-89

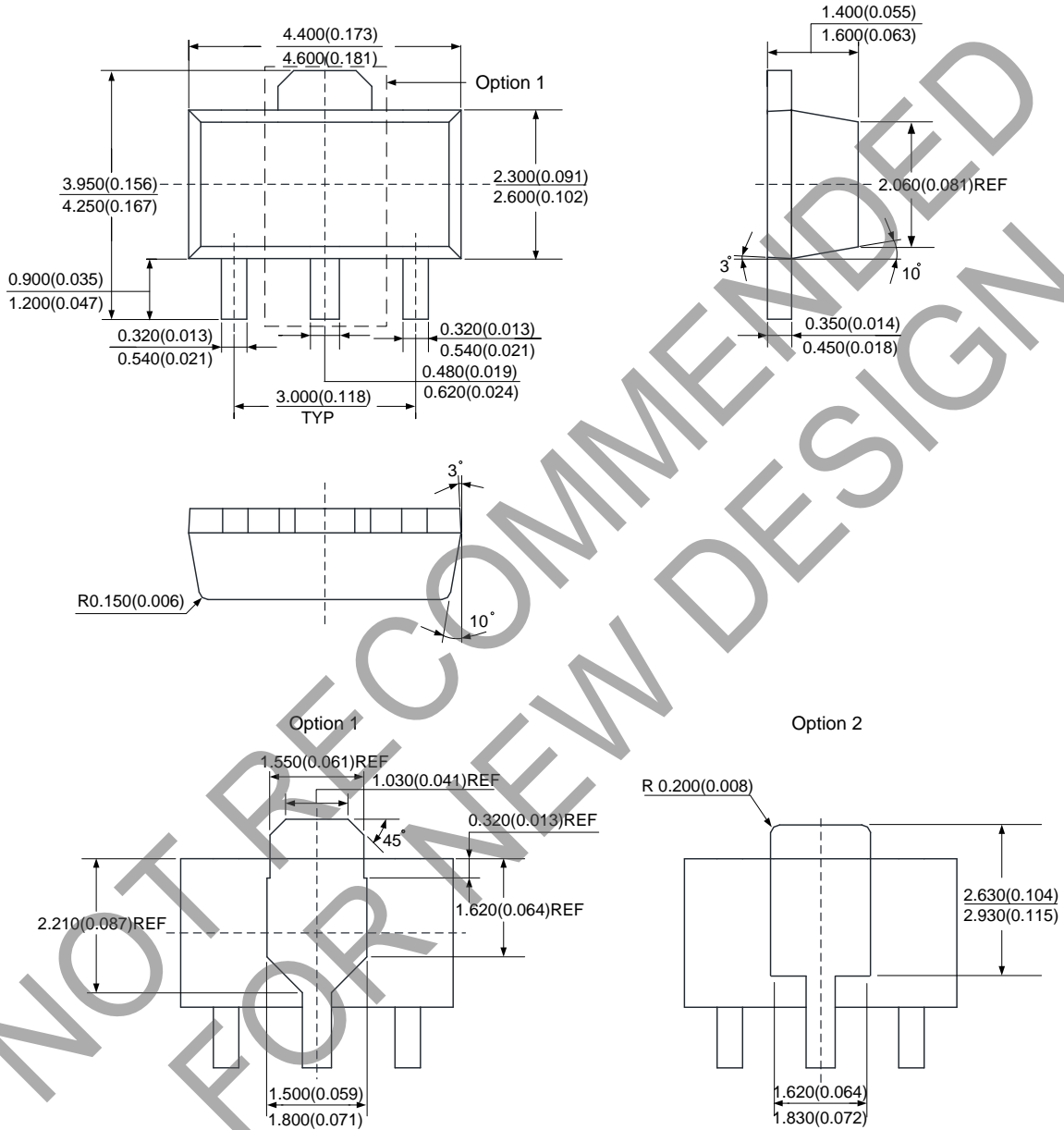

Package Outline Dimensions (All dimensions in mm(inch).) (continued)

Please see <http://www.diodes.com/package-outlines.html> for the latest version.

(3) Package Type: PSOP-8

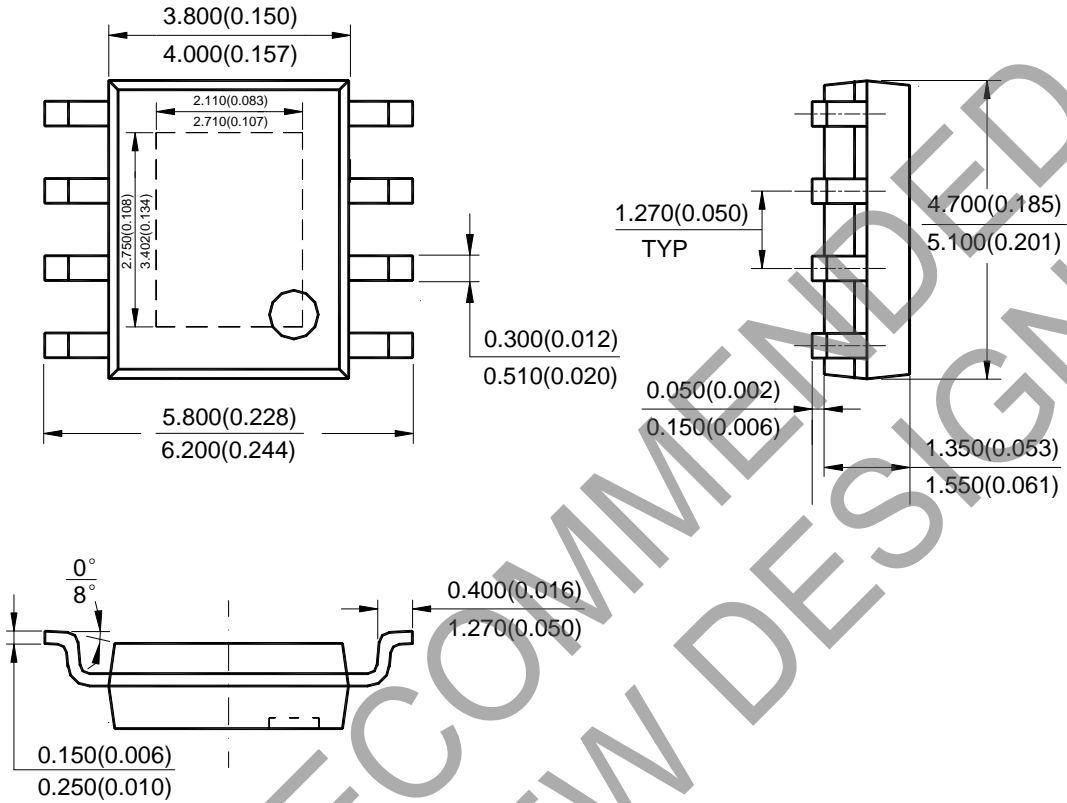

Note: Eject hole, oriented hole and mold mark is optional.

NOT RECOMMENDED FOR NEW DESIGN

Suggested Pad Layout

Please see <http://www.diodes.com/package-outlines.html> for the latest version.

(1) Package Type: SOT-23-5

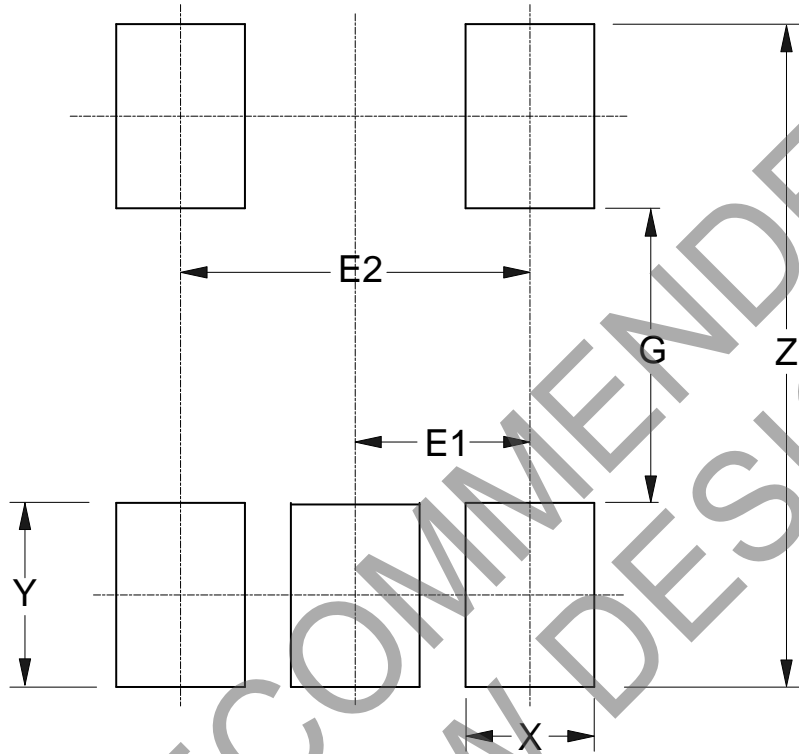

Dimensions	Z (mm)/(inch)	G (mm)/(inch)	X (mm)/(inch)	Y (mm)/(inch)	E1 (mm)/(inch)	E2 (mm)/(inch)
Value	3.600/0.142	1.600/0.063	0.700/0.028	1.000/0.039	0.950/0.037	1.900/0.075

Suggested Pad Layout (continued)

Please see <http://www.diodes.com/package-outlines.html> for the latest version.

(2) Package Type: SOT-89

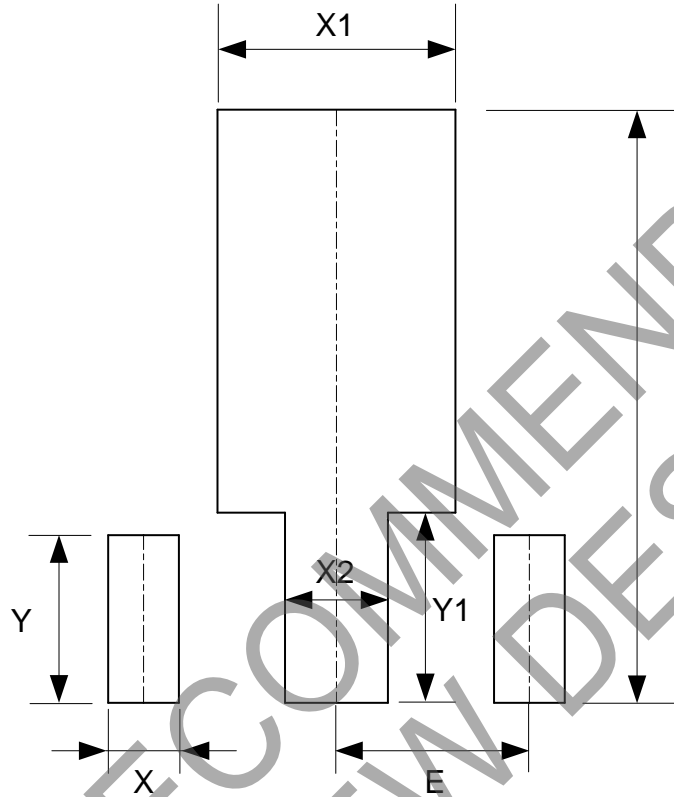

Dimensions	Z (mm)/(inch)	X (mm)/(inch)	X1 (mm)/(inch)	X2 (mm)/(inch)	Y (mm)/(inch)	Y1 (mm)/(inch)	E (mm)/(inch)
Value	4.600/0.181	0.550/0.022	1.850/0.073	0.800/0.031	1.300/0.051	1.475/0.058	1.500/0.059

Suggested Pad Layout (continued)

Please see <http://www.diodes.com/package-outlines.html> for the latest version.

(3) Package Type: PSOP-8

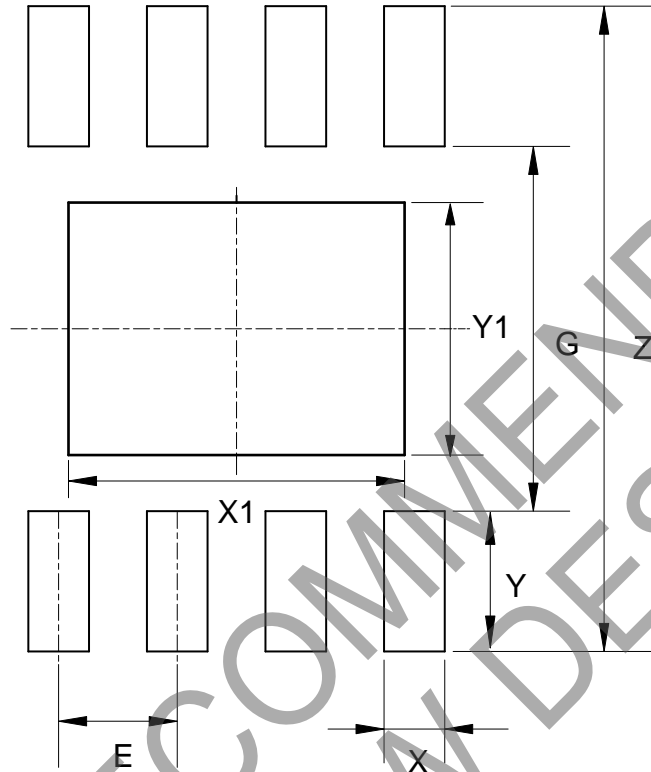

Dimensions	Z (mm)/(inch)	G (mm)/(inch)	X (mm)/(inch)	Y (mm)/(inch)	X1 (mm)/(inch)	Y1 (mm)/(inch)	E (mm)/(inch)
Value	6.900/0.272	3.900/0.154	0.650/0.026	1.500/0.059	3.600/0.142	2.700/0.106	1.270/0.050

IMPORTANT NOTICE

1. DIODES INCORPORATED (Diodes) AND ITS SUBSIDIARIES MAKE NO WARRANTY OF ANY KIND, EXPRESS OR IMPLIED, WITH REGARDS TO ANY INFORMATION CONTAINED IN THIS DOCUMENT, INCLUDING, BUT NOT LIMITED TO, THE IMPLIED WARRANTIES OF MERCHANTABILITY, FITNESS FOR A PARTICULAR PURPOSE OR NON-INFRINGEMENT OF THIRD PARTY INTELLECTUAL PROPERTY RIGHTS (AND THEIR EQUIVALENTS UNDER THE LAWS OF ANY JURISDICTION).
2. The Information contained herein is for informational purpose only and is provided only to illustrate the operation of Diodes' products described herein and application examples. Diodes does not assume any liability arising out of the application or use of this document or any product described herein. This document is intended for skilled and technically trained engineering customers and users who design with Diodes' products. Diodes' products may be used to facilitate safety-related applications; however, in all instances customers and users are responsible for (a) selecting the appropriate Diodes products for their applications, (b) evaluating the suitability of Diodes' products for their intended applications, (c) ensuring their applications, which incorporate Diodes' products, comply the applicable legal and regulatory requirements as well as safety and functional-safety related standards, and (d) ensuring they design with appropriate safeguards (including testing, validation, quality control techniques, redundancy, malfunction prevention, and appropriate treatment for aging degradation) to minimize the risks associated with their applications.
3. Diodes assumes no liability for any application-related information, support, assistance or feedback that may be provided by Diodes from time to time. Any customer or user of this document or products described herein will assume all risks and liabilities associated with such use, and will hold Diodes and all companies whose products are represented herein or on Diodes' websites, harmless against all damages and liabilities.
4. Products described herein may be covered by one or more United States, international or foreign patents and pending patent applications. Product names and markings noted herein may also be covered by one or more United States, international or foreign trademarks and trademark applications. Diodes does not convey any license under any of its intellectual property rights or the rights of any third parties (including third parties whose products and services may be described in this document or on Diodes' website) under this document.
5. Diodes' products are provided subject to Diodes' Standard Terms and Conditions of Sale (<https://www.diodes.com/about/company/terms-and-conditions/terms-and-conditions-of-sales/>) or other applicable terms. This document does not alter or expand the applicable warranties provided by Diodes. Diodes does not warrant or accept any liability whatsoever in respect of any products purchased through unauthorized sales channel.
6. Diodes' products and technology may not be used for or incorporated into any products or systems whose manufacture, use or sale is prohibited under any applicable laws and regulations. Should customers or users use Diodes' products in contravention of any applicable laws or regulations, or for any unintended or unauthorized application, customers and users will (a) be solely responsible for any damages, losses or penalties arising in connection therewith or as a result thereof, and (b) indemnify and hold Diodes and its representatives and agents harmless against any and all claims, damages, expenses, and attorney fees arising out of, directly or indirectly, any claim relating to any noncompliance with the applicable laws and regulations, as well as any unintended or unauthorized application.
7. While efforts have been made to ensure the information contained in this document is accurate, complete and current, it may contain technical inaccuracies, omissions and typographical errors. Diodes does not warrant that information contained in this document is error-free and Diodes is under no obligation to update or otherwise correct this information. Notwithstanding the foregoing, Diodes reserves the right to make modifications, enhancements, improvements, corrections or other changes without further notice to this document and any product described herein. This document is written in English but may be translated into multiple languages for reference. Only the English version of this document is the final and determinative format released by Diodes.
8. Any unauthorized copying, modification, distribution, transmission, display or other use of this document (or any portion hereof) is prohibited. Diodes assumes no responsibility for any losses incurred by the customers or users or any third parties arising from any such unauthorized use.
9. This Notice may be periodically updated with the most recent version available at <https://www.diodes.com/about/company/terms-and-conditions/important-notice>

DIODES is a trademark of Diodes Incorporated in the United States and other countries.
The Diodes logo is a registered trademark of Diodes Incorporated in the United States and other countries.
© 2022 Diodes Incorporated. All Rights Reserved.

www.diodes.com