

**500mA LOW NOISE LDO REGULATOR****AP2213****General Description**

The AP2213 is a 500mA output current fixed voltage regulator which provides low noise, very low dropout voltage (typically 350mV at 500mA), very low standby current (1 $\mu$ A maximum) and excellent power supply ripple rejection (PSRR 75dB at 100Hz) in battery powered applications, such as handsets and PDAs and in noise sensitive applications, such as RF electronics.

The AP2213 features individual logic compatible enable/shutdown control inputs, a low power shutdown mode for extended battery life, over current protection, over temperature protection, as well as reversed-battery protection.

The AP2213 has 2.5V, 3.0V and 3.3V versions.

The AP2213 is available in TO-252-2 (1) and SOIC-8 packages.

**Features**

- Up to 500mA Output Current
- Low Standby Current
- Low Dropout Voltage:  $V_{DROP}=350mV$  at 500mA
- High Output Accuracy:  $\pm 1\%$
- Good Ripple Rejection Ability: 75dB at 100Hz and  $I_{OUT}=100\mu A$
- Tight Load and Line Regulation
- Low Temperature Coefficient
- Over Current Protection
- Thermal Protection
- Reversed-battery Protection
- Logic-controlled Enable

**Applications**

- Laptop, Notebook, and Palmtop Computer
- CD-ROM, CD-R/RW, DVD Driver
- Portable Electronic
- PC Peripheral

[www.DataSheet4U.com](http://www.DataSheet4U.com)

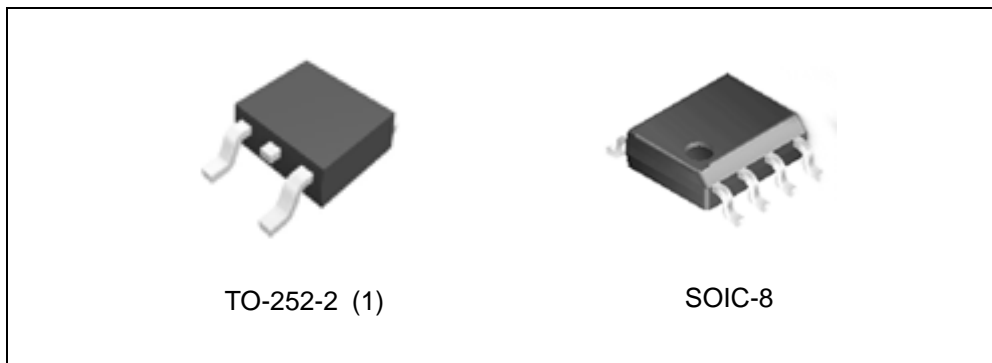

Figure 1. Package Types of AP2213



**500mA LOW NOISE LDO REGULATOR**

**AP2213**

**Pin Configuration**

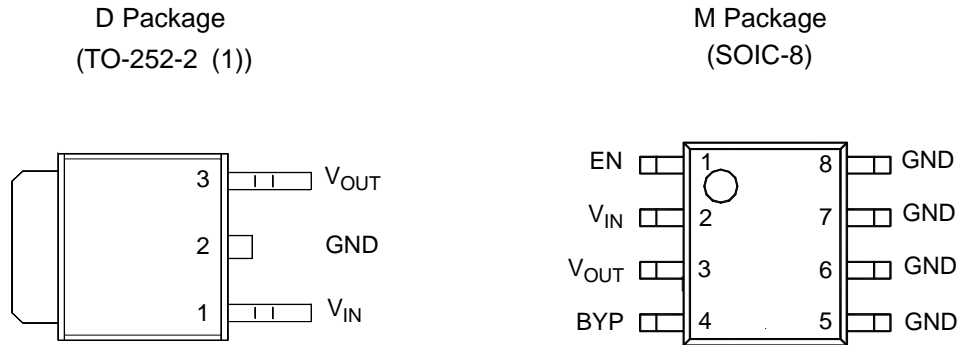

Figure 2. Pin Configuration of AP2213 (Top View)

**Pin Description**

Pin Number		Pin Name	Function
TO-252-2 (1)	SOIC-8		
3	3	$V_{OUT}$	Regulated output voltage
2	5, 6, 7, 8	GND	Ground
1	2	$V_{IN}$	Input Voltage
	1	EN	Enable input: CMOS or TTL compatible input. Logic high=enable, logic low=shutdown
	4	BYP	Bypass capacitor for low noise operation



**500mA LOW NOISE LDO REGULATOR**

**AP2213**

**Functional Block Diagram**

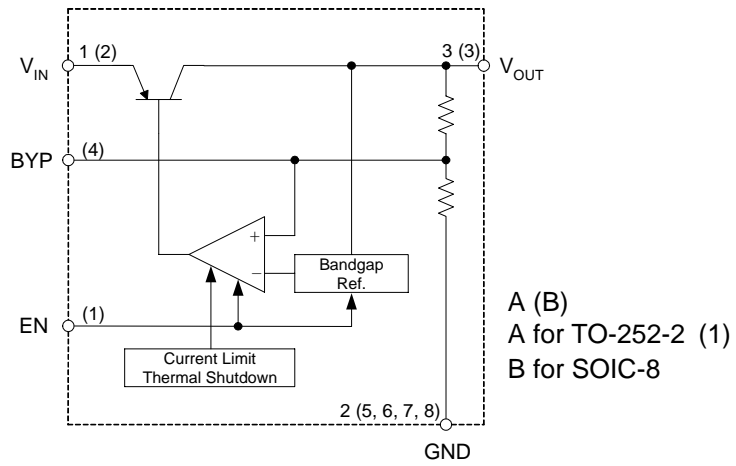

Figure 3. Functional Block Diagram of AP2213



**500mA LOW NOISE LDO REGULATOR**

**AP2213**

**Ordering Information**

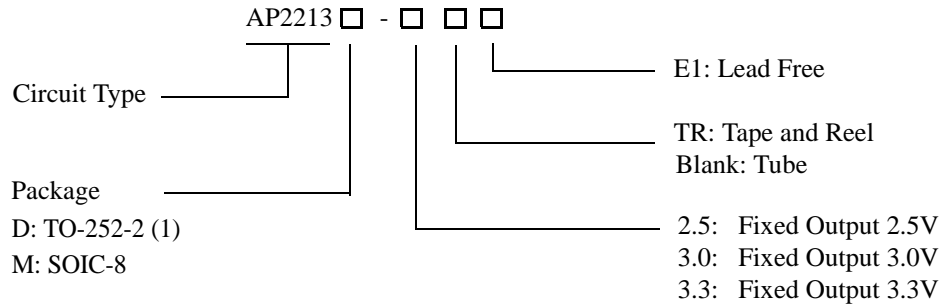

Package	Temperature Range	Part Number	Marking ID	Packing Type
TO-252-2 (1)	-40 to 125°C	AP2213D-2.5E1	AP2213D-2.5E1	Tube
		AP2213D-2.5TRE1	AP2213D-2.5E1	Tape & Reel
		AP2213D-3.0E1	AP2213D-3.0E1	Tube
		AP2213D-3.0TRE1	AP2213D-3.0E1	Tape & Reel
		AP2213D-3.3E1	AP2213D-3.3E1	Tube
		AP2213D-3.3TRE1	AP2213D-3.3E1	Tape & Reel
SOIC-8	-40 to 125°C	AP2213M-2.5E1	2213M-2.5E1	Tube
		AP2213M-2.5TRE1	2213M-2.5E1	Tape & Reel
		AP2213M-3.0E1	2213M-3.0E1	Tube
		AP2213M-3.0TRE1	2213M-3.0E1	Tape & Reel
		AP2213M-3.3E1	2213M-3.3E1	Tube
		AP2213M-3.3TRE1	2213M-3.3E1	Tape & Reel

BCD Semiconductor's Pb-free products, as designated with "E1" suffix in the part number, are RoHS compliant.

**500mA LOW NOISE LDO REGULATOR****AP2213****Absolute Maximum Ratings (Note 1)**

Parameter	Symbol	Value	Unit	
Supply Input Voltage	$V_{IN}$	20	V	
Enable Input Voltage	$V_{EN}$	20	V	
Power Dissipation	$P_D$	Internally Limited (Thermal Protection)	W	
Lead Temperature (Soldering, 10sec)	$T_{LEAD}$	260	°C	
Junction Temperature	$T_J$	150	°C	
Storage Temperature	$T_{STG}$	-65 to 150	°C	
ESD (Machine Model)	ESD	300	V	
Thermal Resistance (No Heatsink)	$\theta_{JA}$	TO-252-2 (1)	90	°C/W
		SOIC-8	160	

Note 1: Stresses greater than those listed under "Absolute Maximum Ratings" may cause permanent damage to the device. These are stress ratings only, and functional operation of the device at these or any other conditions beyond those indicated under "Recommended Operating Conditions" is not implied. Exposure to "Absolute Maximum Ratings" for extended periods may affect device reliability.

**Recommended Operating Conditions**

Parameter	Symbol	Min	Max	Unit
Supply Input Voltage	$V_{IN}$	2.5	18	V
Enable Input Voltage	$V_{EN}$	0	18	V
Operating Junction Temperature	$T_J$	-40	125	°C



**500mA LOW NOISE LDO REGULATOR**

**AP2213**

**Electrical Characteristics**

**AP2213-2.5 Electrical Characteristics**

$V_{IN}=3.5V$ ,  $I_{OUT}=100\mu A$ ,  $C_{IN}=1.0\mu F$ ,  $C_{OUT}=2.2\mu F$ ,  $V_{EN}\geq 2.0V$ ,  $T_J=25^\circ C$ , **Bold** typeface applies over  $-40^\circ C \leq T_J \leq 125^\circ C$  (Note 2), unless otherwise specified.

Parameter	Symbol	Conditions	Min	Typ	Max	Unit
Output Voltage Accuracy	$\Delta V_{OUT}/V_{OUT}$	Variation from specified $V_{OUT}$	-1		1	%
			-2		2	
Output Voltage Temperature Coefficient (Note 3)	$\Delta V_{OUT}/\Delta T$			<b>120</b>		$\mu V/^\circ C$
	$(\Delta V_{OUT}/V_{OUT})/\Delta T$			<b>48</b>		ppm/ $^\circ C$
Line Regulation	$V_{RLINE}$	$V_{IN}=3.5V$ to $13.2V$		1.5	4.5	mV
					<b>12</b>	
Load Regulation (Note 4)	$V_{RLOAD}$	$I_{OUT}=0.1mA$ to $500mA$		1	7	mV
					<b>17</b>	
Dropout Voltage (Note 5)	$V_{DROP}$	$I_{OUT}=100\mu A$		15	50	mV
				<b>70</b>		
		$I_{OUT}=50mA$		110	150	
				<b>230</b>		
		$I_{OUT}=100mA$		140	250	
				<b>300</b>		
		$I_{OUT}=150mA$		165	275	
		<b>350</b>				
		$I_{OUT}=300mA$		250	400	
				<b>500</b>		
		$I_{OUT}=500mA$		350	600	
				<b>700</b>		
Standby Current	$I_{STD}$	$V_{EN}\leq 0.4V$ (shutdown)		0.01	1	$\mu A$
		$V_{EN}\leq 0.18V$ (shutdown)			<b>5</b>	
Ground Pin Current (Note 6)	$I_{GND}$	$V_{EN}\geq 2.0V$ , $I_{OUT}=100\mu A$		100	150	$\mu A$
				<b>180</b>		
		$V_{EN}\geq 2.0V$ , $I_{OUT}=50mA$		350	600	mA
				<b>800</b>		
		$V_{EN}\geq 2.0V$ , $I_{OUT}=150mA$		1.3	1.9	
				<b>2.5</b>		
		$V_{EN}\geq 2.0V$ , $I_{OUT}=300mA$		4	10	
				<b>15</b>		
		$V_{EN}\geq 2.0V$ , $I_{OUT}=500mA$		11	20	
				<b>28</b>		



**500mA LOW NOISE LDO REGULATOR**

**AP2213**

**Electrical Characteristics (Continued)**

**AP2213-2.5 Electrical Characteristics**

$V_{IN}=3.5V$ ,  $I_{OUT}=100\mu A$ ,  $C_{IN}=1.0\mu F$ ,  $C_{OUT}=2.2\mu F$ ,  $V_{EN}\geq 2.0V$ ,  $T_J=25^\circ C$ , **Bold** typeface applies over  $-40^\circ C\leq T_J\leq 125^\circ C$  (Note 2), unless otherwise specified.

Parameter	Symbol	Conditions	Min	Typ	Max	Unit
Ripple Rejection	PSRR	$f=100Hz$ , $I_{OUT}=100\mu A$		75		dB
Current Limit	$I_{LIMIT}$	$V_{OUT}=0V$		<b>700</b>	1000	mA
Output Noise	$e_{no}$	$I_{OUT}=50mA$ , $C_{OUT}=2.2\mu F$ , 100pF from BYP to GND		260		$nV/\sqrt{Hz}$
Enable Input Logic-low Voltage	$V_{IL}$	Regulator shutdown			0.4	V
					<b>0.18</b>	
Enable Input Logic-high Voltage	$V_{IH}$	Regulator enabled	<b>2.0</b>			V
Enable Input Logic-low Current	$I_{IL}$	$V_{IL}\leq 0.4V$		0.01	1	$\mu A$
		$V_{IL}\leq 0.18V$			<b>2</b>	
Enable Input Logic-high Current	$I_{IH}$	$V_{IL}\geq 2.0V$		5	20	$\mu A$
		$V_{IL}\geq 2.0V$			<b>25</b>	

Note 2: Specifications in bold type are limited to  $-40^\circ C\leq T_J\leq 125^\circ C$ . Limits over temperature are guaranteed by design, but not tested in production.

Note 3: Output voltage temperature coefficient is defined as the worst case voltage change divided by the total temperature range.

Note 4: Regulation is measured at constant junction temperature using low duty cycle pulse testing. Parts are tested for load regulation in the load range from 0.1mA to 500mA. Changes in output voltage due to heating effects are covered by the thermal regulation specification.

Note 5: Dropout voltage is defined as the input to output differential at which the output voltage drops 1% ( $T_J=25^\circ C$ ) or 2% ( $-40^\circ C\leq T_J\leq 125^\circ C$ ) below its nominal value measured at 1V differential.

Note 6: Ground pin current is the regulator quiescent current plus pass transistor base current. The total current drawn from the



**500mA LOW NOISE LDO REGULATOR**

**AP2213**

**Electrical Characteristics (Continued)**

**AP2213-3.0 Electrical Characteristics**

$V_{IN}=4V$ ,  $I_{OUT}=100\mu A$ ,  $C_{IN}=1.0\mu F$ ,  $C_{OUT}=2.2\mu F$ ,  $V_{EN}\geq 2.0V$ ,  $T_J=25^\circ C$ , **Bold** typeface applies over  $-40^\circ C \leq T_J \leq 125^\circ C$  (Note 2), unless otherwise specified.

Parameter	Symbol	Conditions	Min	Typ	Max	Unit
Output Voltage Accuracy	$\Delta V_{OUT}/V_{OUT}$	Variation from specified $V_{OUT}$	-1		1	%
			<b>-2</b>		<b>2</b>	
Output Voltage Temperature Coefficient (Note 3)	$\Delta V_{OUT}/\Delta T$			<b>120</b>		$\mu V/^\circ C$
	$(\Delta V_{OUT}/V_{OUT})/\Delta T$			<b>40</b>		ppm/ $^\circ C$
Line Regulation	$V_{RLINE}$	$V_{IN}=4V$ to 13.2V		1.5	4.5	mV
					<b>12</b>	
Load Regulation (Note 4)	$V_{RLOAD}$	$I_{OUT}=0.1mA$ to 500mA		1	8	mV
					<b>17</b>	
Dropout Voltage (Note 5)	$V_{DROP}$	$I_{OUT}=100\mu A$		15	50	mV
				<b>70</b>		
		$I_{OUT}=50mA$		110	150	
				<b>230</b>		
		$I_{OUT}=100mA$		140	250	
				<b>300</b>		
		$I_{OUT}=150mA$		165	275	
		<b>350</b>				
		$I_{OUT}=300mA$		250	400	
				<b>500</b>		
		$I_{OUT}=500mA$		350	600	
				<b>700</b>		
Standby Current	$I_{STD}$	$V_{EN}\leq 0.4V$ (shutdown)		0.01	1	$\mu A$
		$V_{EN}\leq 0.18V$ (shutdown)			<b>5</b>	
Ground Pin Current (Note 6)	$I_{GND}$	$V_{EN}\geq 2.0V$ , $I_{OUT}=100\mu A$		100	150	$\mu A$
				<b>180</b>		
		$V_{EN}\geq 2.0V$ , $I_{OUT}=50mA$		350	600	
				<b>800</b>		
		$V_{EN}\geq 2.0V$ , $I_{OUT}=150mA$		1.3	1.9	mA
				<b>2.5</b>		
$V_{EN}\geq 2.0V$ , $I_{OUT}=300mA$		4	10			
		<b>15</b>				
$V_{EN}\geq 2.0V$ , $I_{OUT}=500mA$		11	20			
		<b>28</b>				





**500mA LOW NOISE LDO REGULATOR**

**AP2213**

**Electrical Characteristics (Continued)**

**AP2213-3.0 Electrical Characteristics**

$V_{IN}=4V$ ,  $I_{OUT}=100\mu A$ ,  $C_{IN}=1.0\mu F$ ,  $C_{OUT}=2.2\mu F$ ,  $V_{EN}\geq 2.0V$ ,  $T_J=25^\circ C$ , **Bold** typeface applies over  $-40^\circ C \leq T_J \leq 125^\circ C$  (Note 2), unless otherwise specified.

Parameter	Symbol	Conditions	Min	Typ	Max	Unit
Ripple Rejection	PSRR	$f=100Hz$ , $I_{OUT}=100\mu A$		75		dB
Current Limit	$I_{LIMIT}$	$V_{OUT}=0V$		<b>700</b>	1000	mA
Output Noise	$e_{no}$	$I_{OUT}=50mA$ , $C_{OUT}=2.2\mu F$ , 100pF from BYP to GND		260		$nV/\sqrt{Hz}$
Enable Input Logic-low Voltage	$V_{IL}$	Regulator shutdown			0.4	V
					<b>0.18</b>	
Enable Input Logic-high Voltage	$V_{IH}$	Regulator enabled	<b>2.0</b>			V
Enable Input Logic-low Current	$I_{IL}$	$V_{IL}\leq 0.4V$		0.01	1	$\mu A$
		$V_{IL}\leq 0.18V$			<b>2</b>	
Enable Input Logic-high Current	$I_{IH}$	$V_{IL}\geq 2.0V$		5	20	$\mu A$
		$V_{IL}\geq 2.0V$			<b>25</b>	

Note 2: Specifications in bold type are limited to  $-40^\circ C \leq T_J \leq 125^\circ C$ . Limits over temperature are guaranteed by design, but not tested in production.

Note 3: Output voltage temperature coefficient is defined as the worst case voltage change divided by the total temperature range.

Note 4: Regulation is measured at constant junction temperature using low duty cycle pulse testing. Parts are tested for load regulation in the load range from 0.1mA to 500mA. Changes in output voltage due to heating effects are covered by the thermal regulation specification.

Note 5: Dropout voltage is defined as the input to output differential at which the output voltage drops 1% ( $T_J=25^\circ C$ ) or 2% ( $-40^\circ C \leq T_J \leq 125^\circ C$ ) below its nominal value measured at 1V differential.

Note 6: Ground pin current is the regulator quiescent current plus pass transistor base current. The total current drawn from the supply is the sum of the load current plus the ground pin current.



**500mA LOW NOISE LDO REGULATOR**

**AP2213**

**Electrical Characteristics (Continued)**

**AP2213-3.3 Electrical Characteristics**

$V_{IN}=4.3V$ ,  $I_{OUT}=100\mu A$ ,  $C_{IN}=1.0\mu F$ ,  $C_{OUT}=2.2\mu F$ ,  $V_{EN}\geq 2.0V$ ,  $T_J=25^\circ C$ , **Bold** typeface applies over  $-40^\circ C \leq T_J \leq 125^\circ C$  (Note 2), unless otherwise specified.

Parameter	Symbol	Conditions	Min	Typ	Max	Unit
Output Voltage Accuracy	$\Delta V_{OUT}/V_{OUT}$	Variation from specified $V_{OUT}$	-1		1	%
			<b>-2</b>		<b>2</b>	
Output Voltage Temperature Coefficient (Note 3)	$\Delta V_{OUT}/\Delta T$			<b>120</b>		$\mu V/^\circ C$
	$(\Delta V_{OUT}/V_{OUT})/\Delta T$			<b>36.3</b>		ppm/ $^\circ C$
Line Regulation	$V_{RLINE}$	$V_{IN}=4.3V$ to $13.2V$		1.5	4.5	mV
					<b>12</b>	
Load Regulation (Note 4)	$V_{RLOAD}$	$I_{OUT}=0.1mA$ to $500mA$		1	9	mV
					<b>18</b>	
Dropout Voltage (Note 5)	$V_{DROP}$	$I_{OUT}=100\mu A$		15	50	mV
				<b>70</b>		
		$I_{OUT}=50mA$		110	150	
				<b>230</b>		
		$I_{OUT}=100mA$		140	250	
				<b>300</b>		
		$I_{OUT}=150mA$		165	275	
				<b>350</b>		
		$I_{OUT}=300mA$		250	400	
				<b>500</b>		
		$I_{OUT}=500mA$		350	600	
				<b>700</b>		
Standby Current	$I_{STD}$	$V_{EN}\leq 0.4V$ (shutdown)		0.01	1	$\mu A$
		$V_{EN}\leq 0.18V$ (shutdown)			<b>5</b>	
Ground Pin Current (Note 6)	$I_{GND}$	$V_{EN}\geq 2.0V$ , $I_{OUT}=100\mu A$		100	150	$\mu A$
				<b>180</b>		
		$V_{EN}\geq 2.0V$ , $I_{OUT}=50mA$		350	600	
				<b>800</b>		
		$V_{EN}\geq 2.0V$ , $I_{OUT}=150mA$		1.3	1.9	mA
		<b>2.5</b>				
$V_{EN}\geq 2.0V$ , $I_{OUT}=300mA$		4	10			
				<b>15</b>		
		$V_{EN}\geq 2.0V$ , $I_{OUT}=500mA$		11	20	
				<b>28</b>		



**500mA LOW NOISE LDO REGULATOR**

**AP2213**

**Electrical Characteristics (Continued)**

**AP2213-3.3 Electrical Characteristics**

$V_{IN}=4.3V$ ,  $I_{OUT}=100\mu A$ ,  $C_{IN}=1.0\mu F$ ,  $C_{OUT}=2.2\mu F$ ,  $V_{EN}\geq 2.0V$ ,  $T_J=25^\circ C$ , **Bold** typeface applies over  $-40^\circ C \leq T_J \leq 125^\circ C$  (Note 2), unless otherwise specified.

Parameter	Symbol	Conditions	Min	Typ	Max	Unit
Ripple Rejection	PSRR	$f=100Hz$ , $I_{OUT}=100\mu A$		75		dB
Current Limit	$I_{LIMIT}$	$V_{OUT}=0V$		<b>700</b>	1000	mA
Output Noise	$e_{no}$	$I_{OUT}=50mA$ , $C_{OUT}=2.2\mu F$ , 100pF from BYP to GND		260		$nV/\sqrt{Hz}$
Enable Input Logic-low Voltage	$V_{IL}$	Regulator shutdown			0.4	V
					<b>0.18</b>	
Enable Input Logic-high Voltage	$V_{IH}$	Regulator enabled	<b>2.0</b>			V
Enable Input Logic-low Current	$I_{IL}$	$V_{IL}\leq 0.4V$		0.01	1	$\mu A$
		$V_{IL}\leq 0.18V$			<b>2</b>	
Enable Input Logic-high Current	$I_{IH}$	$V_{IL}\geq 2.0V$		5	20	$\mu A$
		$V_{IL}\geq 2.0V$			<b>25</b>	

Note 2: Specifications in bold type are limited to  $-40^\circ C \leq T_J \leq 125^\circ C$ . Limits over temperature are guaranteed by design, but not tested in production.

Note 3: Output voltage temperature coefficient is defined as the worst case voltage change divided by the total temperature range.

Note 4: Regulation is measured at constant junction temperature using low duty cycle pulse testing. Parts are tested for load regulation in the load range from 0.1mA to 500mA. Changes in output voltage due to heating effects are covered by the thermal regulation specification.

Note 5: Dropout voltage is defined as the input to output differential at which the output voltage drops 1% ( $T_J=25^\circ C$ ) or 2% ( $-40^\circ C \leq T_J \leq 125^\circ C$ ) below its nominal value measured at 1V differential.

Note 6: Ground pin current is the regulator quiescent current plus pass transistor base current. The total current drawn from the supply is the sum of the load current plus the ground pin current.



**500mA LOW NOISE LDO REGULATOR**

**AP2213**

**Typical Performance Characteristics**

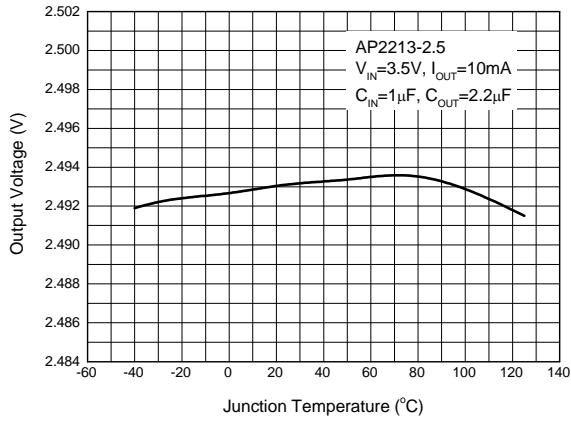

Figure 4. Output Voltage vs. Junction Temperature

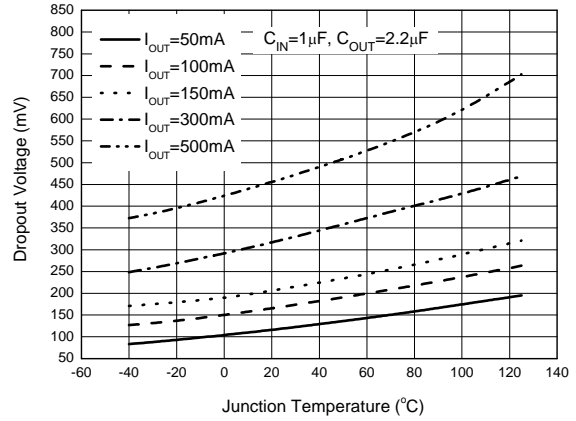

Figure 5. Dropout Voltage vs. Junction Temperature

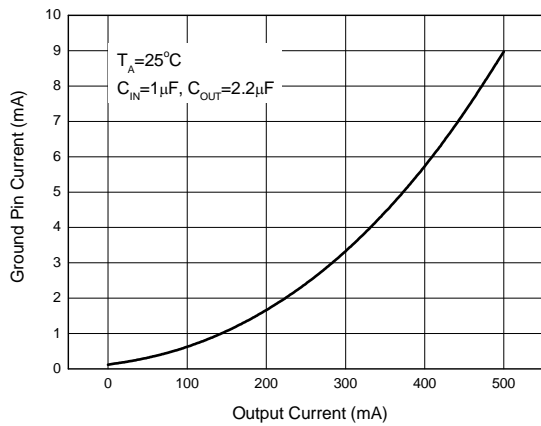

Figure 6. Ground Pin Current vs. Output Current

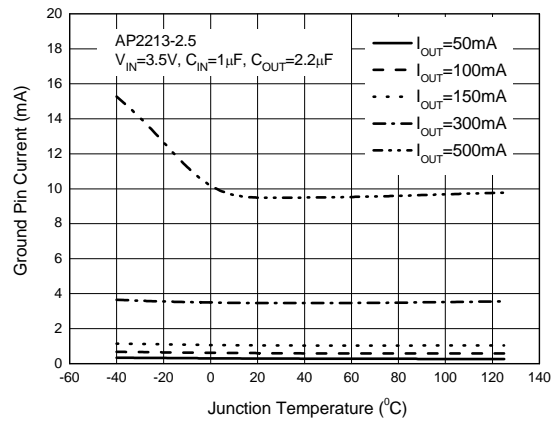

Figure 7. Ground Pin Current vs. Junction Temperature



**500mA LOW NOISE LDO REGULATOR**

**AP2213**

**Typical Performance Characteristics (Continued)**

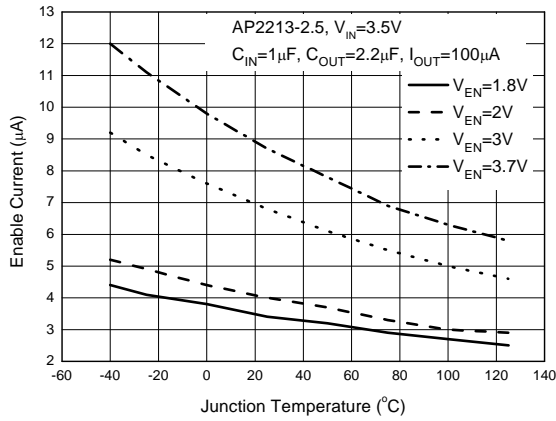

Figure 8. Enable Current vs. Junction Temperature

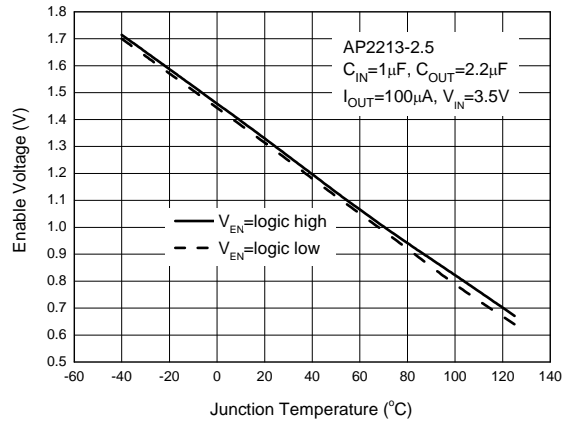

Figure 9. Enable Voltage vs. Junction Temperature

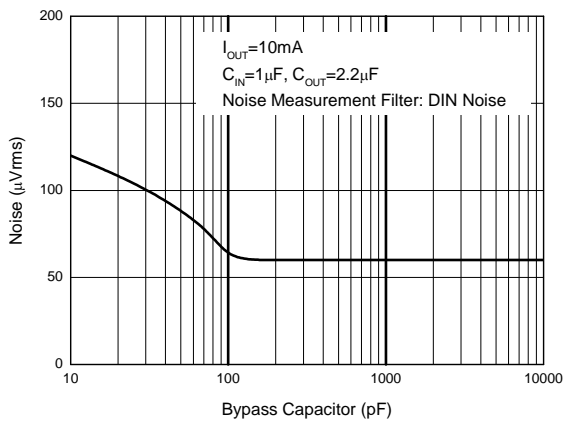

Figure 10. Noise vs. Bypass Capacitor

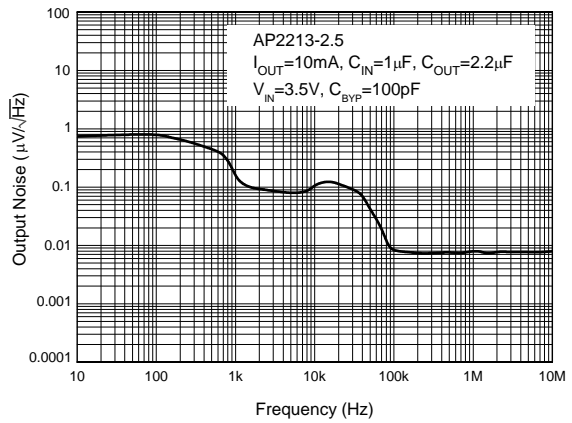

Figure 11. Output Noise vs. Frequency



**500mA LOW NOISE LDO REGULATOR**

**AP2213**

**Typical Performance Characteristics (Continued)**

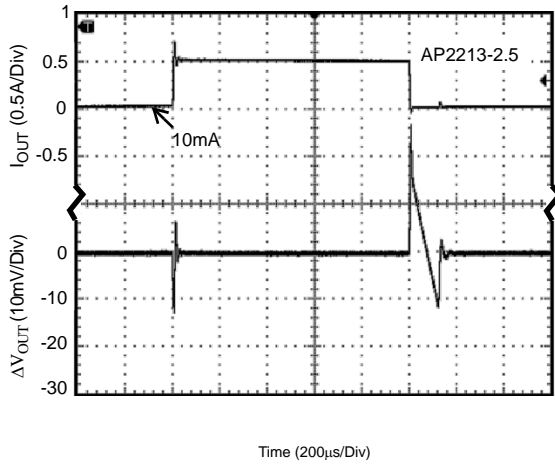

Figure 12. Load Transient  
 (Conditions:  $V_{IN}=3.5V$ ,  $C_{BYP}=100pF$ ,  $V_{EN}=2V$ ,  
 $I_{OUT}=10$  to  $500mA$ ,  $C_{IN}=1μF$ ,  $C_{OUT}=2.2μF$ )

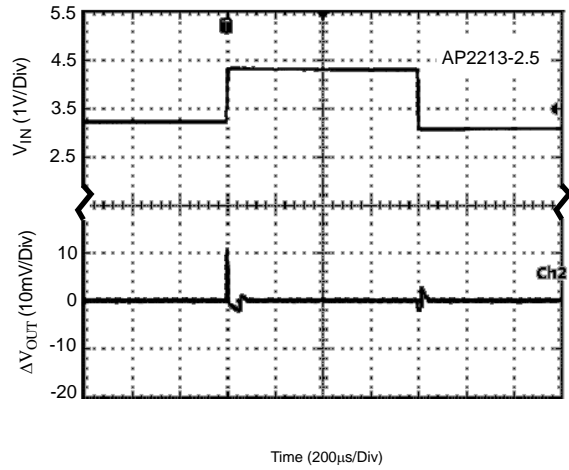

Figure 13. Line Transient  
 (Conditions:  $V_{IN}=3.4$  to  $4.4V$ ,  $V_{EN}=2V$ ,  $I_{OUT}=100μA$ ,  
 $C_{BYP}=100pF$ ,  $C_{OUT}=2.2μF$ )

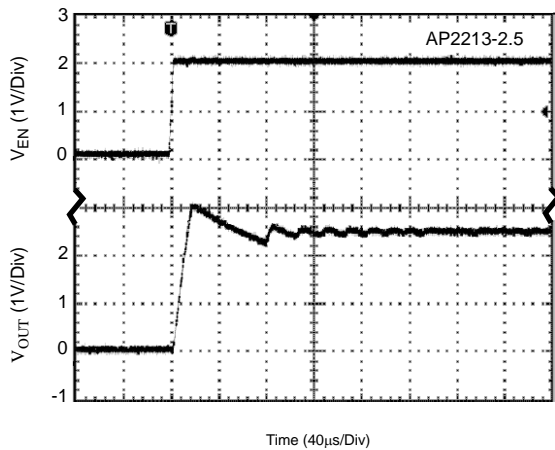

Figure 14.  $V_{EN}$  vs.  $V_{OUT}$   
 (Conditions:  $V_{EN}=0$  to  $2V$ ,  $V_{IN}=3.5V$ ,  $I_{OUT}=30mA$ ,  
 $C_{BYP}=open$ ,  $C_{IN}=1μF$ ,  $C_{OUT}=2.2μF$ )

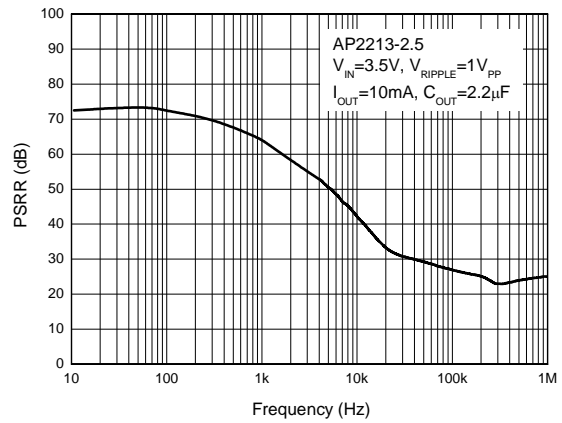

Figure 15. PSRR vs. Frequency



**500mA LOW NOISE LDO REGULATOR**

**AP2213**

**Typical Performance Characteristics (Continued)**

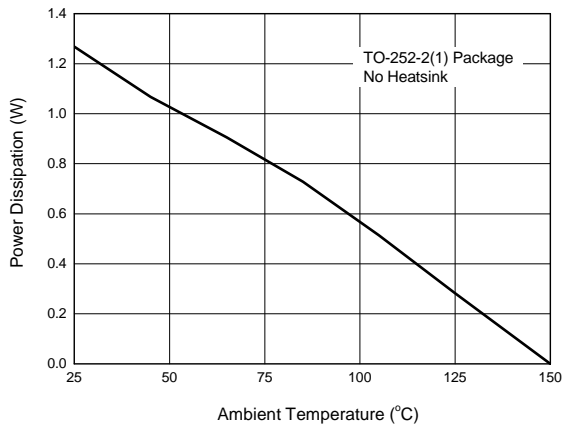

Figure 16. Power Dissipation vs. Ambient Temperature

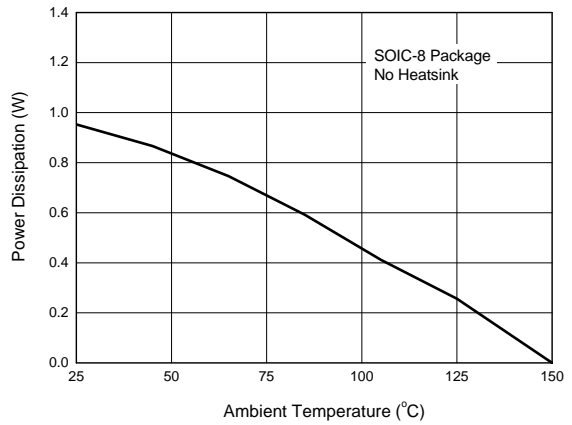

Figure 17. Power Dissipation vs. Ambient Temperature

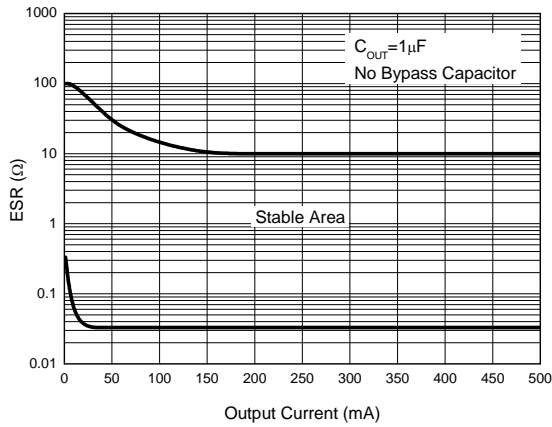

Figure 18. ESR vs. Output Current

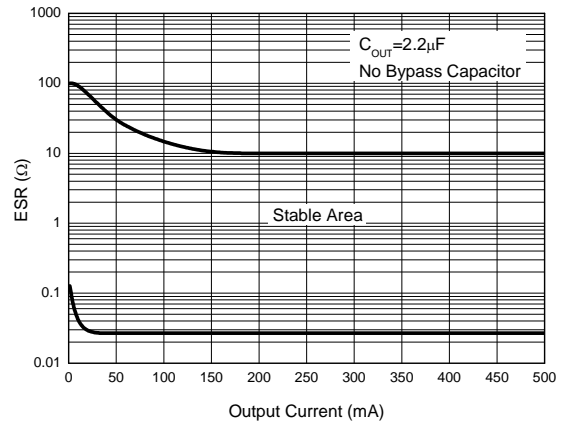

Figure 19. ESR vs. Output Current



**500mA LOW NOISE LDO REGULATOR**

**AP2213**

**Typical Performance Characteristics (Continued)**

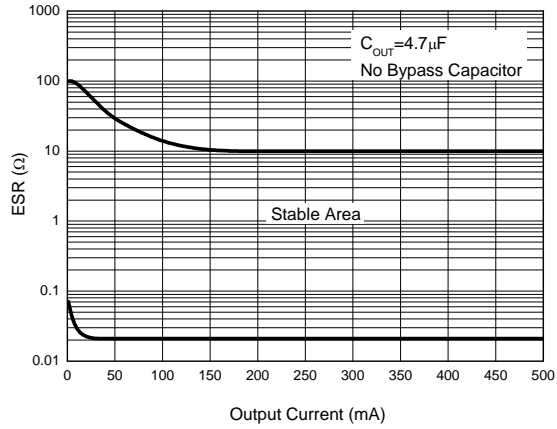

Figure 20. ESR vs. Output Current



**500mA LOW NOISE LDO REGULATOR****AP2213****Typical Application**

Figure 21. Typical Application of AP2213 (Note 7)

Note 7: Dropout voltage is 350mV when  $T_A=25^\circ\text{C}$ . In order to obtain a normal output voltage,  $V_{\text{OUT}}+0.35\text{V}$  is the minimum input voltage which will result in a low PSRR, imposing a bad influence on system. Therefore, the recommended input voltage is  $V_{\text{OUT}}+1\text{V}$  to 18V. For AP2213-2.5 version, its input voltage can be set from  $3.5\text{V}(V_{\text{OUT}}+1\text{V})$  to 18V.

**500mA LOW NOISE LDO REGULATOR****AP2213****Application Information****Input Capacitor**

A 1 $\mu$ F minimum capacitor is recommended to be placed between  $V_{IN}$  and GND.

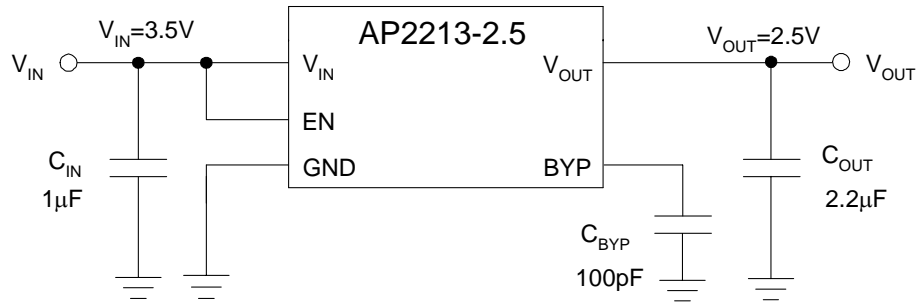
**Output Capacitor**

It is required to prevent oscillation. 1 $\mu$ F minimum is recommended when  $C_{BYP}$  is unused. 2.2 $\mu$ F minimum is recommended when  $C_{BYP}$  is 100pF. The output capacitor may be increased to improve transient response.

**Noise Bypass Capacitor**

Bypass capacitor is connected to the internal voltage reference. A 100pF capacitor connected from BYP to GND make this reference quiet, resulting in a significant reduction in output noise, but the ESR stable area will be narrowed.

The start-up speed of the AP2213 is inversely proportional to the value of reference bypass capacitor. In some cases, if output noise is not a major concern and rapid turn-on is necessary, omit  $C_{BYP}$  and leave BYP open.

**Power Dissipation**

Thermal shutdown may take place if exceeding the maximum power dissipation in application. Under all possible operating conditions, the junction temperature must be within the range specified under absolute maximum ratings to avoid thermal shutdown.

To determine if the power dissipated in the regulator reaches the maximum power dissipation (see figure 16, 17), using:

$$T_J = P_D * \theta_{JA} + T_A$$

$$P_D = (V_{IN} - V_{OUT}) * I_{OUT} + V_{IN} * I_{GND}$$

Where:  $T_J \leq T_{J(max)}$ .  $T_{J(max)}$  is absolute maximum ratings for the junction temperature;  $V_{IN} * I_{GND}$  can be ignored due to its small value.

$T_{J(max)}$  is 150 $^{\circ}$ C,  $\theta_{JA}$  is 90 $^{\circ}$ C/W for TO-252-2 (1) package and 160 $^{\circ}$ C/W for SOIC-8 package.

Example: For 2.5V version packaged in SOIC-8,  $I_{OUT} = 500\text{mA}$ ,  $T_A = 50^{\circ}\text{C}$ ,  $V_{IN(Max)}$  is:

$$(150^{\circ}\text{C} - 50^{\circ}\text{C}) / (0.5\text{A} * 160^{\circ}\text{C/W}) + 2.5\text{V} = 3.75\text{V}$$

Therefore, for good performance, please make sure that input voltage is less than 3.75V without heatsink when  $T_A = 50^{\circ}\text{C}$ .



**500mA LOW NOISE LDO REGULATOR**

**AP2213**

**Mechanical Dimensions**

**TO-252-2(1)**

**Unit: mm(inch)**

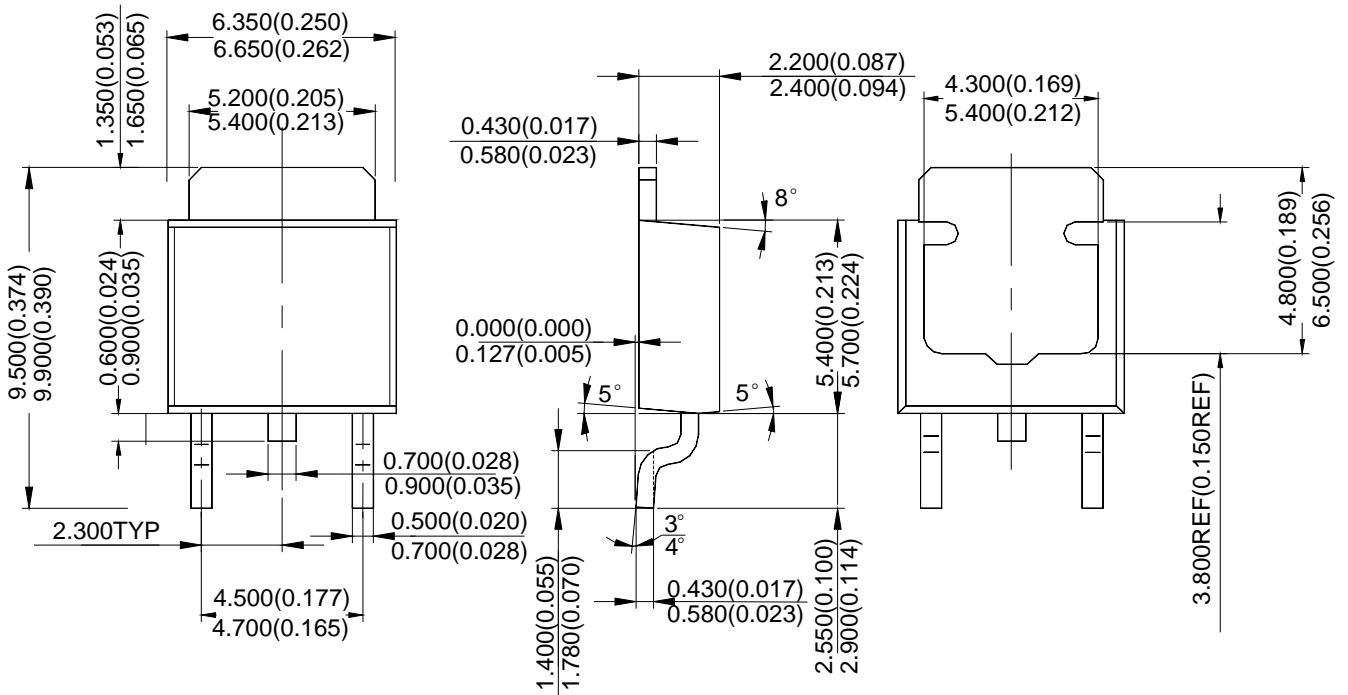



500mA LOW NOISE LDO REGULATOR

AP2213

Mechanical Dimensions (Continued)

SOIC-8

Unit: mm(inch)

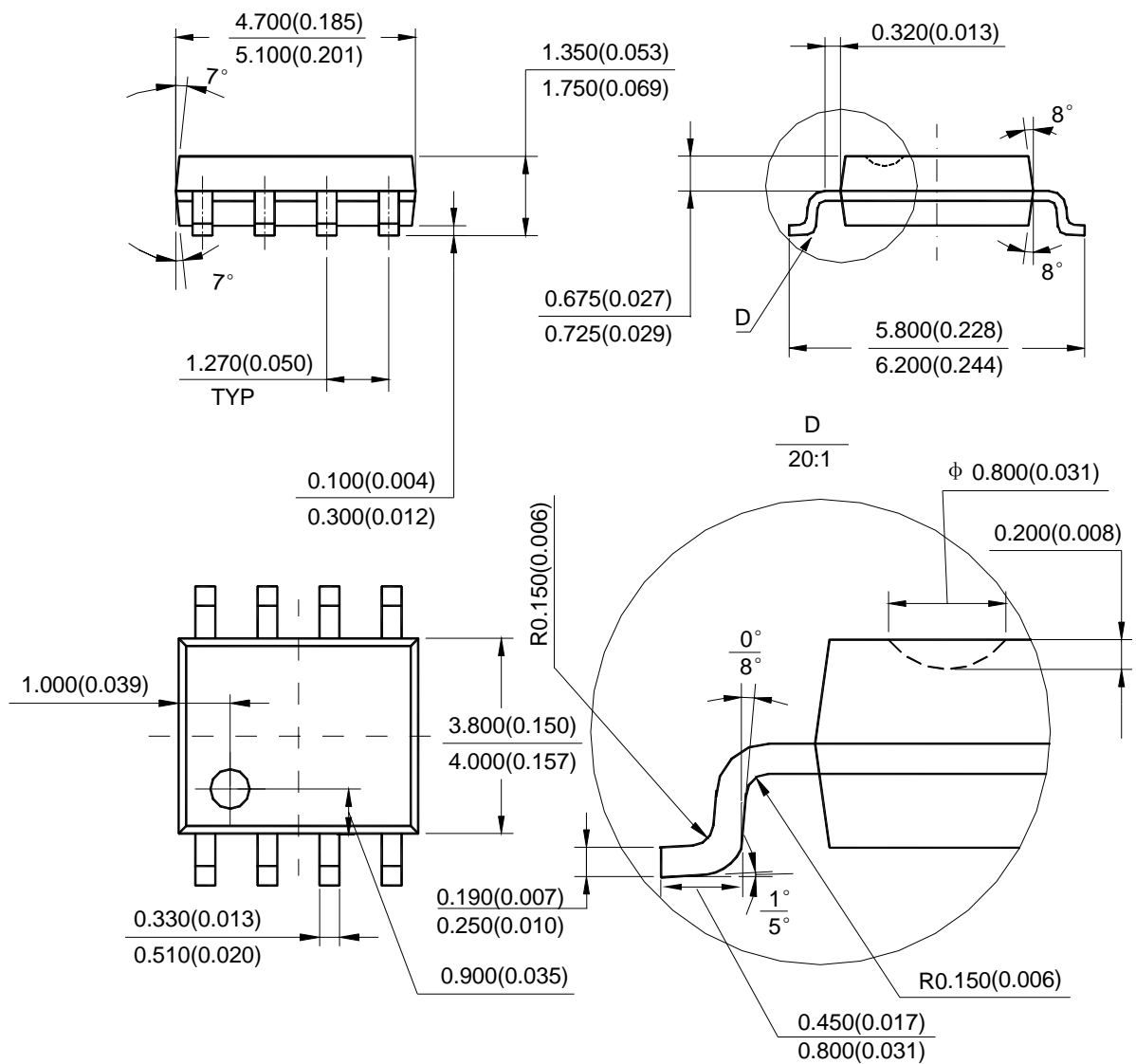



BCD Semiconductor Manufacturing Limited

<http://www.bcdsemi.com>

#### IMPORTANT NOTICE

BCD Semiconductor Manufacturing Limited reserves the right to make changes without further notice to any products or specifications herein. BCD Semiconductor Manufacturing Limited does not assume any responsibility for use of any its products for any particular purpose, nor does BCD Semiconductor Manufacturing Limited assume any liability arising out of the application or use of any its products or circuits. BCD Semiconductor Manufacturing Limited does not convey any license under its patent rights or other rights nor the rights of others.

---

#### MAIN SITE

**BCD Semiconductor Manufacturing Limited**  
- Wafer Fab  
Shanghai SIM-BCD Semiconductor Manufacturing Limited  
800, Yi Shan Road, Shanghai 200233, China  
Tel: +86-21-6485 1491, Fax: +86-21-5450 0008

**BCD Semiconductor Manufacturing Limited**  
- IC Design Group  
Advanced Analog Circuits (Shanghai) Corporation  
8F, Zone B, 900, Yi Shan Road, Shanghai 200233, China  
Tel: +86-21-6495 9539, Fax: +86-21-6485 9673

#### REGIONAL SALES OFFICE

**Shenzhen Office**  
Shanghai SIM-BCD Semiconductor Manufacturing Co., Ltd. Shenzhen Office  
Advanced Analog Circuits (Shanghai) Corporation Shenzhen Office  
Room E, 5F, Noble Center, No.1006, 3rd Fuzhong Road, Futian District, Shenzhen 518026, China  
Tel: +86-755-8826 7951  
Fax: +86-755-8826 7865

**Taiwan Office**  
BCD Semiconductor (Taiwan) Company Limited  
4F, 298-1, Rui Guang Road, Nei-Hu District, Taipei,  
Taiwan  
Tel: +886-2-2656 2808  
Fax: +886-2-2656 2806

**USA Office**  
BCD Semiconductor Corporation  
30920 Huntwood Ave. Hayward,  
CA 94544, U.S.A  
Tel : +1-510-324-2988  
Fax: +1-510-324-2788