

**600mA LOW DROPOUT LINEAR REGULATOR****AP2316****General Description**

The AP2316 is a series of low dropout three-terminal regulators with a dropout of 1.1V at 600mA output current.

This product has been optimized for low voltage where transient response and minimum input voltage are critical. The AP2316 provides current limit and thermal shutdown. Its circuit includes a trimmed bandgap reference to assure output voltage accuracy to be within $\pm 1\%$. On-chip thermal shutdown provides protection against any combination of overload and ambient temperatures that would create excessive junction temperatures.

The AP2316 is available in 2.5V and 3.3V versions. The fixed versions integrate the corresponding resistor divider.

The AP2316 is available in the industry standard SOT-89-3 power package.

Features

- Low Dropout Voltage: 1.1V at 600mA Output Current
- Output Noise from 10Hz to 10KHz: 0.003% of V_{OUT}
- PSRR at $I_{OUT}=300mA$ and $f=120Hz$: 75dB
- Output Voltage Accuracy: $\pm 1\%$
- On-chip Thermal Shutdown
- Maximum Quiescent Current: $I_{QMAX}=5mA$
- ESD (Human Body Model): 3.5KV
- Operation Junction Temperature: -40 to $125^{\circ}C$

Applications

- DVD/CD-ROM
- USB Device
- Add-on Card
- DVD Player
- PC Motherboard

www.DataSheet4U.com

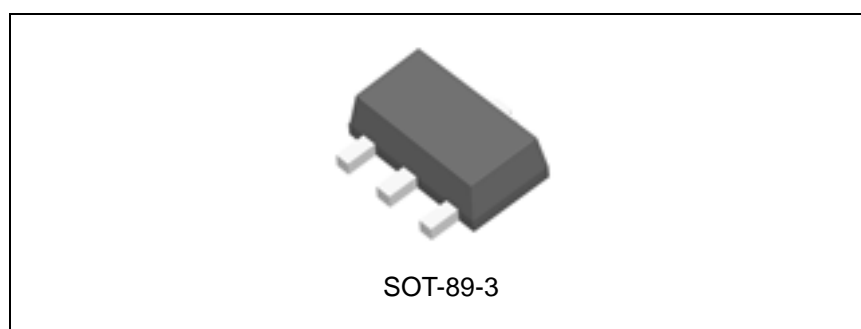

Figure 1. Package Type of AP2316



600mA LOW DROPOUT LINEAR REGULATOR

AP2316

Pin Configuration

R Package
(SOT-89-3)

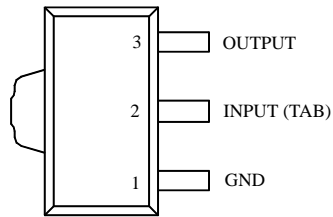

Figure 2. Pin Configuration of AP2316 (Top View)



600mA LOW DROPOUT LINEAR REGULATOR

AP2316

Functional Block Diagram

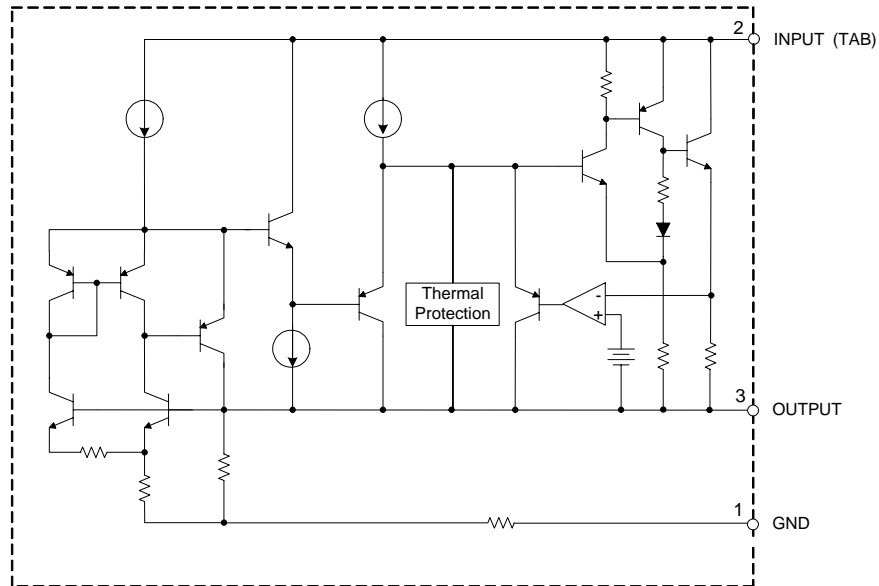

Figure 3. Functional Block Diagram of AP2316



600mA LOW DROPOUT LINEAR REGULATOR

AP2316

Ordering Information

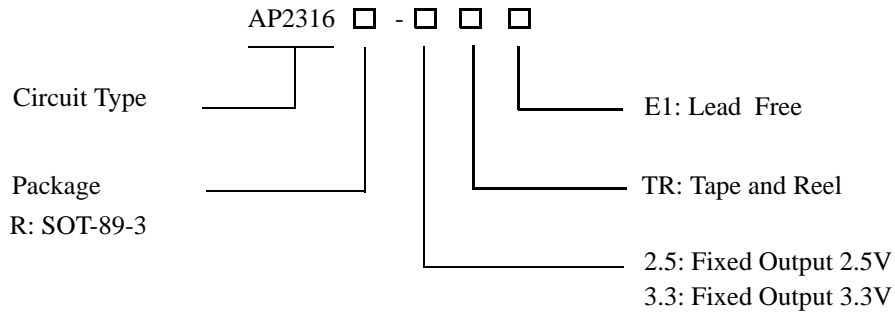

Package	Temperature Range	Part Number	Marking ID	Packing Type
SOT-89-3	-40 to 125°C	AP2316R-2.5TRE1	E27H	Tape & Reel
		AP2316R-3.3TRE1	E27J	Tape & Reel

BCD Semiconductor's Pb-free products, as designated with "E1" suffix in the part number, are RoHS compliant.

**600mA LOW DROPOUT LINEAR REGULATOR****AP2316****Absolute Maximum Ratings (Note 1)**

Parameter	Symbol	Value	Unit	
Input Voltage	V_{IN}	15	V	
Operating Junction Temperature	T_J	150	°C	
Storage Temperature Range	T_{STG}	-65 to 150	°C	
Lead Temperature (Soldering, 10sec)	T_{LEAD}	260	°C	
Thermal Resistance (Note 2)	θ_{JA}	SOT-89-3	165	°C/W
ESD (Human Body Model)	ESD	3500	V	
ESD (Machine Model)	ESD	350	V	

Note 1: Stresses greater than those listed under "Absolute Maximum Ratings" may cause permanent damage to the device. These are stress ratings only, and functional operation of the device at these or any other conditions beyond those indicated under "Recommended Operating Conditions" is not implied. Exposure to "Absolute Maximum Ratings" for extended periods may affect device reliability.

Note 2: Absolute maximum ratings indicate limits beyond which damage to the component may occur. Electrical specifications do not apply when operating the device outside of its operating ratings. The maximum allowable power dissipation is a function of the maximum junction temperature, $T_{J(max)}$, the junction-to-ambient thermal resistance, θ_{JA} , and the ambient temperature, T_A . The maximum allowable power dissipation at any ambient temperature is calculated using: $P_{D(max)} = (T_{J(max)} - T_A) / \theta_{JA}$. Exceeding the maximum allowable power dissipation will result in excessive die temperature, and the regulator will go into thermal shutdown.

Recommended Operating Conditions

Parameter	Symbol	Min	Max	Unit
Input Voltage	V_{IN}		12	V
Operating Junction Temperature Range	T_J	-40	125	°C



600mA LOW DROPOUT LINEAR REGULATOR

AP2316

Electrical Characteristics

Operating Conditions: $V_{IN} \leq 10V$, $T_J = 25^\circ C$, unless otherwise specified. ($P \leq$ maximum power dissipation)

Limits appearing in **Boldface** type apply over the entire junction temperature range for operation, $-40^\circ C$ to $125^\circ C$

Parameter	Symbol	Conditions	Min	Typ	Max	Unit
Output Voltage	V_{OUT}	AP2316-2.5 $I_{OUT} = 10mA$, $V_{IN} = 4.5V$, $T_J = 25^\circ C$ $10mA \leq I_{OUT} \leq 600mA$, $3.9V \leq V_{IN} \leq 10V$	2.475 2.450	2.5 2.5	2.525 2.550	V
		AP2316-3.3 $I_{OUT} = 10mA$, $V_{IN} = 5.0V$, $T_J = 25^\circ C$ $10mA \leq I_{OUT} \leq 600mA$, $4.75V \leq V_{IN} \leq 10V$	3.267 3.235	3.3 3.3	3.333 3.365	V
Line Regulation	ΔV_{OUT}	AP2316-2.5 $I_{OUT} = 10mA$, $1.5V \leq V_{IN} - V_{OUT} \leq 10V$		1	6	mV
		AP2316-3.3 $I_{OUT} = 10mA$, $1.5V \leq V_{IN} - V_{OUT} \leq 10V$		1	6	mV
Load Regulation	ΔV_{OUT}	AP2316-2.5 $(V_{IN} - V_{OUT}) = 2V$, $10mA \leq I_{OUT} \leq 600mA$		1	10	mV
		AP2316-3.3 $(V_{IN} - V_{OUT}) = 2V$, $10mA \leq I_{OUT} \leq 600mA$		1	10	mV
Dropout Voltage	V_{DROP}	$\Delta V_{OUT} = 1\%$, $I_{OUT} = 0.6A$		1.1	1.3	V
Current Limit	I_{LIMIT}	$(V_{IN} - V_{OUT}) = 2V$	0.75	0.9		A
Quiescent Current	I_Q	$V_{IN} = V_{OUT} + 1.25V$			5	mA
Ripple Rejection	PSRR	$f = 120Hz$, $C_{OUT} = 22\mu F$ $(V_{IN} - V_{OUT}) = 3V$, $I_{OUT} = 300mA$	60	75		dB
Temperature Stability				0.5		%
Long-Term Stability		$T_A = 125^\circ C$, 1000hrs.		0.3		%
RMS Output Noise (% of V_{OUT})		$T_A = 25^\circ C$, $10Hz \leq f \leq 10KHz$		0.003		%
Thermal Shutdown		Junction Temperature		150		$^\circ C$
Thermal Shutdown Hysteresis				25		$^\circ C$



600mA LOW DROPOUT LINEAR REGULATOR

AP2316

Typical Performance Characteristics

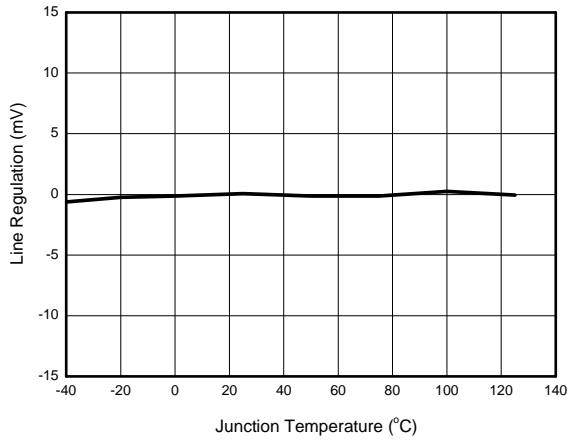

Figure 4. Line Regulation vs. Junction Temperature

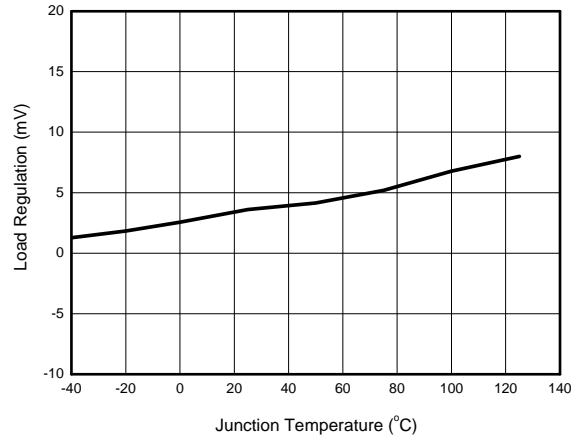

Figure 5. Load Regulation vs. Junction Temperature

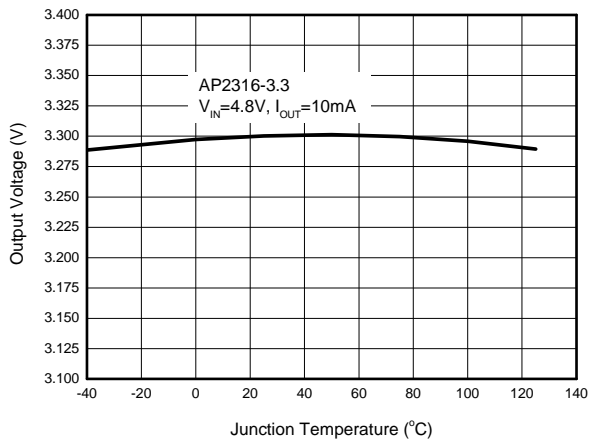

Figure 6. Output Voltage vs. Junction Temperature

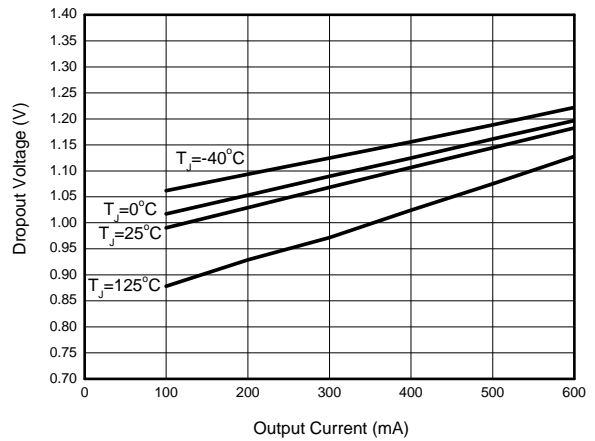

Figure 7. Dropout Voltage vs. Output Current



600mA LOW DROPOUT LINEAR REGULATOR

AP2316

Typical Performance Characteristics (Continued)

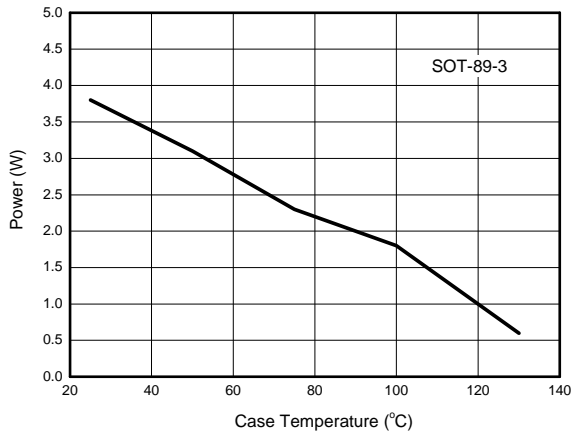

Figure 8. Maximum Power Dissipation

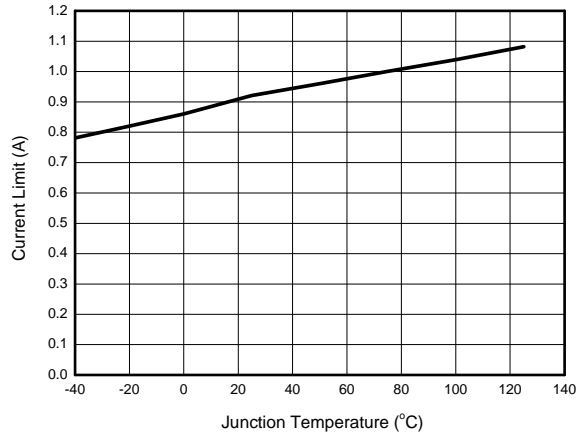

Figure 9. Current Limit vs. Junction Temperature

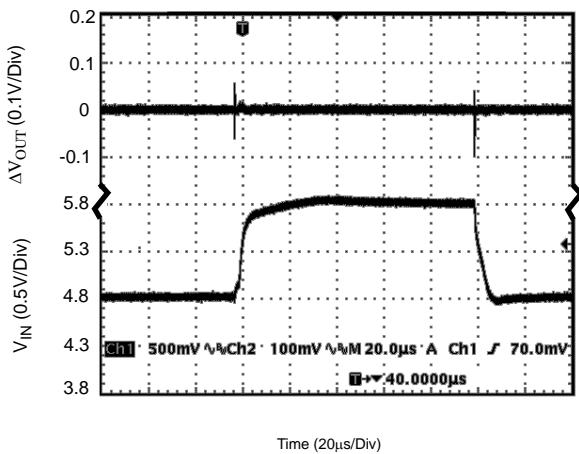

Figure 10. Line Transient Response
(Conditions: $V_{IN}=4.8$ to $5.8V$, $V_{OUT}=3.33V$, $I_{OUT}=0.1A$, $C_{IN}=1\mu F$, $C_{OUT}=10\mu F$)

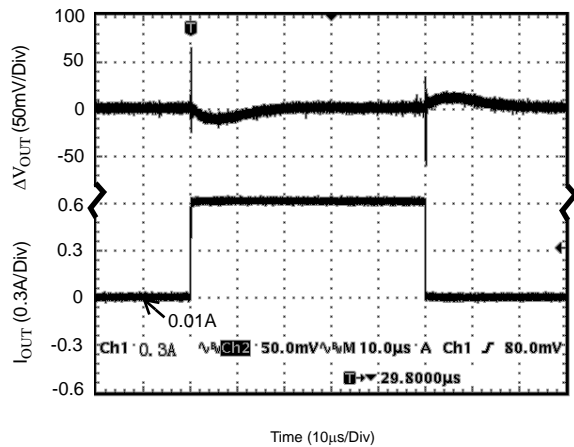

Figure 11. Load Transient Response
(Conditions: $V_{IN}=4.8V$, $V_{OUT}=3.33V$, $I_{OUT}=0.01$ to $0.6A$, $C_{IN}=C_{OUT}=10\mu F$)



600mA LOW DROPOUT LINEAR REGULATOR

AP2316

Typical Performance Characteristics (Continued)

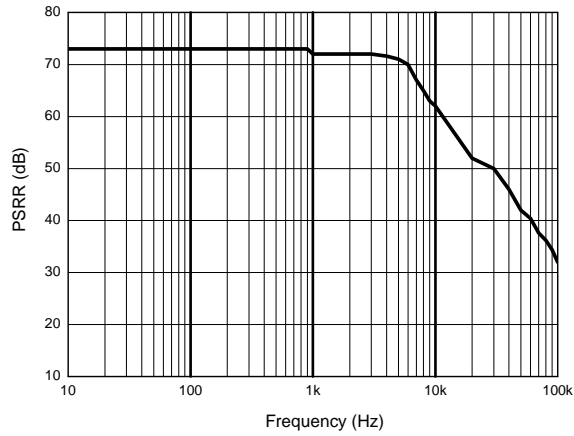

Figure 12. PSRR vs. Frequency



600mA LOW DROPOUT LINEAR REGULATOR

AP2316

Typical Application

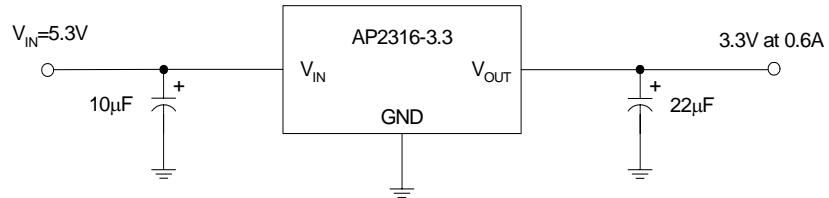

Figure 13. Typical Application of AP2316



600mA LOW DROPOUT LINEAR REGULATOR

AP2316

Mechanical Dimensions

SOT-89-3

Unit: mm(inch)

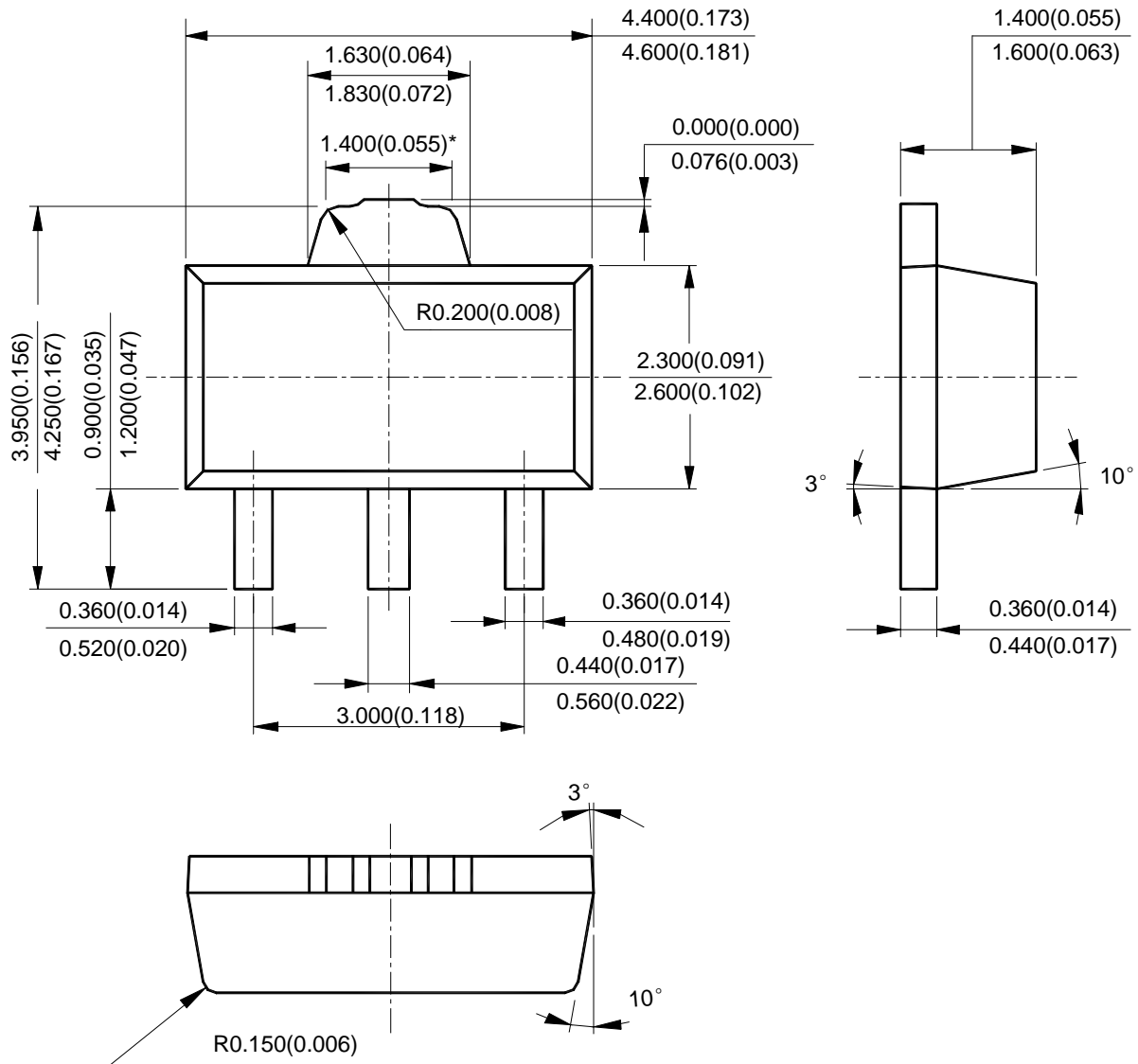



BCD Semiconductor Manufacturing Limited

<http://www.bcdsemi.com>

IMPORTANT NOTICE

BCD Semiconductor Manufacturing Limited reserves the right to make changes without further notice to any products or specifications herein. BCD Semiconductor Manufacturing Limited does not assume any responsibility for use of any its products for any particular purpose, nor does BCD Semiconductor Manufacturing Limited assume any liability arising out of the application or use of any its products or circuits. BCD Semiconductor Manufacturing Limited does not convey any license under its patent rights or other rights nor the rights of others.

MAIN SITE

BCD Semiconductor Manufacturing Limited
- Wafer Fab
Shanghai SIM-BCD Semiconductor Manufacturing Limited
800, Yi Shan Road, Shanghai 200233, China
Tel: +86-21-6485 1491, Fax: +86-21-5450 0008

BCD Semiconductor Manufacturing Limited
- IC Design Group
Advanced Analog Circuits (Shanghai) Corporation
8F, Zone B, 900, Yi Shan Road, Shanghai 200233, China
Tel: +86-21-6495 9539, Fax: +86-21-6485 9673

REGIONAL SALES OFFICE

Shenzhen Office
Shanghai SIM-BCD Semiconductor Manufacturing Co., Ltd. Shenzhen Office
Advanced Analog Circuits (Shanghai) Corporation Shenzhen Office
Room E, 5F, Noble Center, No.1006, 3rd Fuzhong Road, Futian District, Shenzhen 518026, China
Tel: +86-755-8826 7951
Fax: +86-755-8826 7865

Taiwan Office
BCD Semiconductor (Taiwan) Company Limited
4F, 298-1, Rui Guang Road, Nei-Hu District, Taipei,
Taiwan
Tel: +886-2-2656 2808
Fax: +886-2-2656 2806

USA Office
BCD Semiconductor Corporation
30920 Huntwood Ave. Hayward,
CA 94544, U.S.A
Tel : +1-510-324-2988
Fax: +1-510-324-2788