

**WHITE LED STEP-UP CONVERTER****AP3033****General Description**

The AP3033 is an inductor-based DC/DC boost converter designed to drive LED arrays. 1.3A switching current allows AP3033 to be used in different 7' to 10' LCD panel backlights (3S8P LED arrays typically).

A constant frequency 1MHz PWM control scheme is employed in this IC, which means tiny external components can be used. Specifically, 1mm tall 10 $\mu$ H inductor and 10 $\mu$ F output capacitor for the typical application is sufficient.

The over output voltage protection is equipped in AP3033, which protects the IC under open load condition. The AP3033 includes UVLO, soft-start, standby mode, current limit and OTSD to protect the circuit.

The AP3033 is available in standard TSOT-23-6 package.

**Features**

- Up to 92% Efficiency ( $V_{IN}=9V$ ,  $I_{OUT}=160mA$ )
- Up to 88% Efficiency ( $V_{IN}=5V$ ,  $I_{OUT}=160mA$ )
- Fast 1MHz Switching Frequency
- Wide Input Voltage Range: 3V to 16V
- Low 200mV Feedback Voltage
- Output Over Voltage Protection
- Cycle by Cycle Current Limit: 1.3A
- High Frequency PWM Dimming
- Built-in Soft-start
- Built-in Thermal Shutdown Function
- Under Voltage Lockout

**Applications**

- 7' to 10' LCD Panels
- Digital Photo Frame
- GPS Receiver
- Netbook
- PDVD

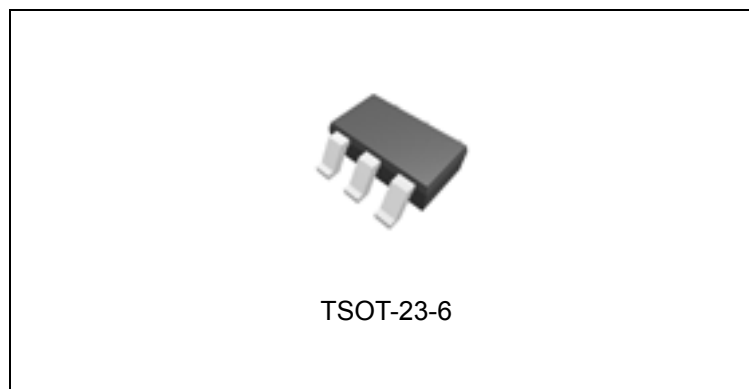

Figure 1. Package Type of AP3033

**WHITE LED STEP-UP CONVERTER**
**AP3033**
**Pin Configuration**

Figure 2. Pin Configuration of AP3033 (Top View)

**Pin Description**

Pin Number	Pin Name	Function
1	SW	Switch Pin. Connect external inductor and Schottky
2	GND	Ground Pin
3	FB	Voltage Feedback Pin. Reference voltage is 200mV
4	CTRL	Enable and Dimming Control Pin. Connect to a high input to enable the IC or a low input to disable the IC. If logic low time is more than about 0.45ms and then enable the IC, the AP3033 will soft start to protect system departments. If logic low time is less than about 0.45ms and then enable the IC, the AP3033 will hold on standby mode and start directly to achieve high frequency dimming
5	OV	Over-voltage Protection Input Pin. Connect to the output directly or connect to the $V_{OUT}$ through a resistor divider to set the OVP voltage. On OVP condition, the output voltage will be clamped
6	$V_{IN}$	Input Supply Pin. Must be locally bypassed

**WHITE LED STEP-UP CONVERTER**

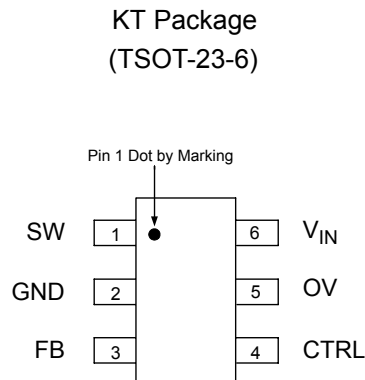
**AP3033**

**Functional Block Diagram**

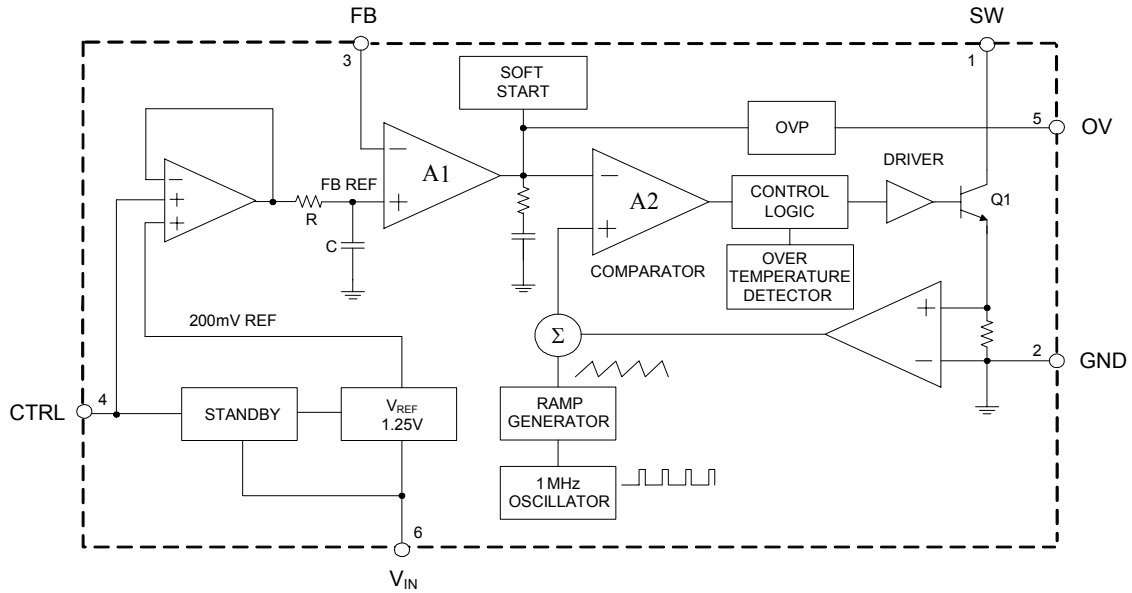
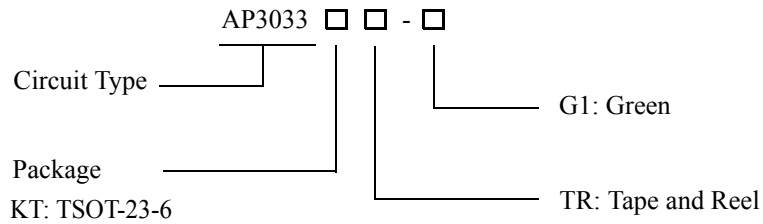

Figure 3. Functional Block Diagram of AP3033

**Ordering Information**



Package	Temperature Range	Part Number	Marking ID	Packing Type
TSOT-23-6	-40 to 85°C	AP3033KTTR-G1	L8G	Tape & Reel

BCD Semiconductor's Pb-free products, as designated with "G1" suffix in the part number, are RoHS compliant and green.

**WHITE LED STEP-UP CONVERTER****AP3033****Absolute Maximum Ratings (Note 1)**

Parameter	Symbol	Value	Unit
Input Voltage	$V_{IN}$	20	V
SW Voltage	$V_{SW}$	38	V
FB Voltage	$V_{FB}$	20	V
OV Voltage	$V_{OV}$	20	V
CTRL Voltage	$V_{CTRL}$	20	V
Thermal Resistance (Junction to Ambient, No Heat Sink)	$\theta_{JA}$	265	$^{\circ}C/W$
Operating Junction Temperature	$T_J$	150	$^{\circ}C$
Storage Temperature Range	$T_{STG}$	-65 to 150	$^{\circ}C$
Lead Temperature (Soldering, 10sec)	$T_{LEAD}$	260	$^{\circ}C$
ESD (Machine Model)		600	V
ESD (Human Body Model)		4000	V

Note 1: Stresses greater than those listed under "Absolute Maximum Ratings" may cause permanent damage to the device. These are stress ratings only, and functional operation of the device at these or any other conditions beyond those indicated under "Recommended Operating Conditions" is not implied. Exposure to "Absolute Maximum Ratings" for extended periods may affect device reliability.

**Recommended Operating Conditions**

Parameter	Symbol	Min	Max	Unit
Operating Temperature Range	$T_{OP}$	-40	85	$^{\circ}C$
Input Voltage	$V_{IN}$	3	16	V
CTRL Voltage	$V_{CTRL}$		16	V

**WHITE LED STEP-UP CONVERTER****AP3033****Electrical Characteristics**(V<sub>IN</sub>=5.0V, V<sub>CTRL</sub>=5.0V, T<sub>A</sub>=25°C, unless otherwise specified.)

Parameter	Symbol	Conditions	Min	Typ	Max	Unit
Operating Voltage	V <sub>IN</sub>		3.0		16	V
Quiescent Current	I <sub>Q</sub>	V <sub>FB</sub> =V <sub>IN</sub> , no switching	4.0	5.0	6.0	mA
Shutdown Quiescent Current	I <sub>SHDN</sub>	V <sub>CTRL</sub> =0V		50		μA
Feedback Voltage (Note 2)	V <sub>FB</sub>	I <sub>OUT</sub> =20mA, 3 LEDs, T <sub>A</sub> =-40°C to 85°C	<b>188</b>	<b>200</b>	<b>212</b>	mV
FB Pin Bias Current	I <sub>FB</sub>			35	100	nA
Switching Frequency	f		0.75	1	1.3	MHz
Maximum Duty Cycle	D <sub>MAX</sub>		90	93		%
Switch Current Limit	I <sub>LIMIT</sub>	D=60%	1.2	1.3		A
Switch V <sub>CE</sub> Saturation Voltage	V <sub>CESAT</sub>	I <sub>SW</sub> =0.6A		350		mV
Switch Leakage Current		V <sub>SW</sub> =38V		0.01	5	μA
CTRL Pin Voltage	V <sub>CTRL</sub>			1.2		V
CTRL Pin Bias Current	I <sub>CTRL</sub>			60		μA
OVP Voltage	V <sub>OVP</sub>			17		V
Soft-start Time	t <sub>SS</sub>			80		μs
Standby Time	t <sub>STB</sub>			0.45		ms
Thermal Shutdown	T <sub>OTSD</sub>			150		°C

Note 2: The bold type specifications of full temperature range are guaranteed by design (GBD).



**WHITE LED STEP-UP CONVERTER**

**AP3033**

**Typical Performance Characteristics**

(WLED forward voltage ( $V_F$ )=3.2V at  $I_F$ =20mA, unless otherwise noted.)

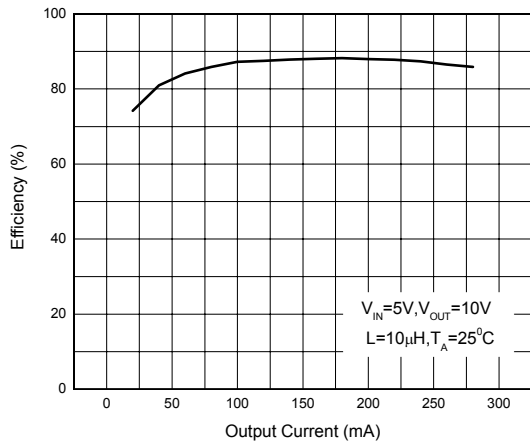

Figure 4. Efficiency vs. Output Current

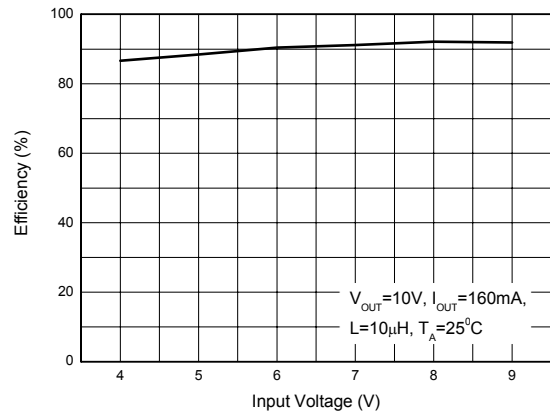

Figure 5. Efficiency vs. Input Voltage

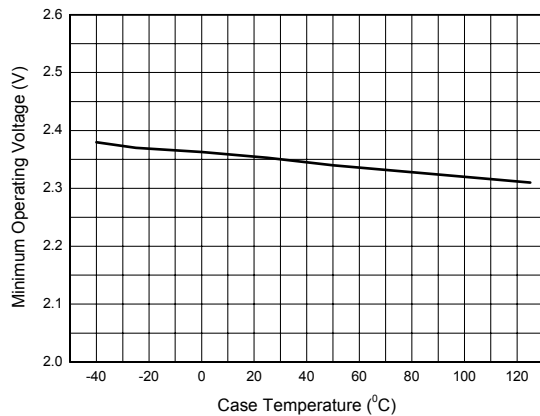

Figure 6. Minimum Operating Voltage vs. Case Temperature

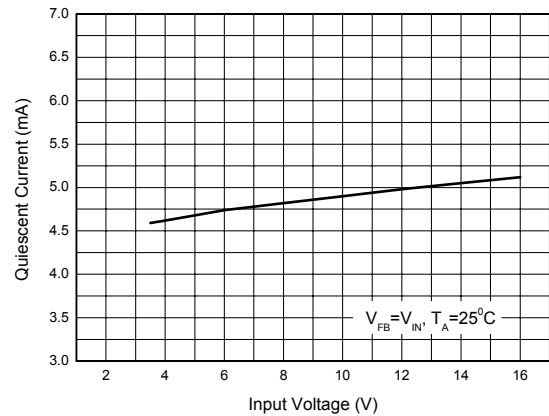

Figure 7. Quiescent Current vs. Input Voltage



**WHITE LED STEP-UP CONVERTER**

**AP3033**

**Typical Performance Characteristics (Continued)**

(WLED forward voltage ( $V_F$ )=3.2V at  $I_F$ =20mA, unless otherwise noted.)

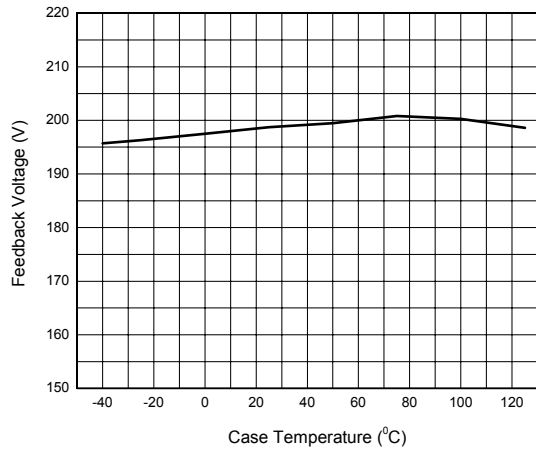

Figure 8. Feedback Voltage vs. Case Temperature

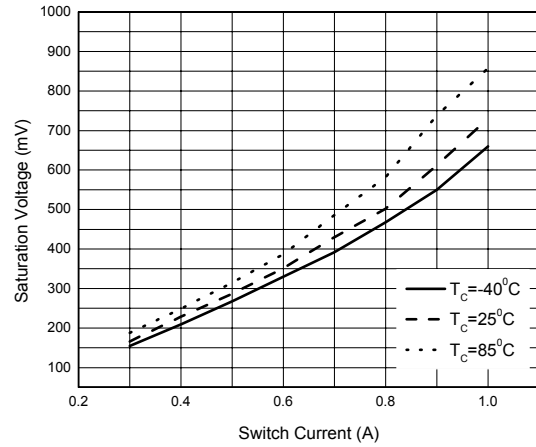

Figure 9. Saturation Voltage vs. Switch Current

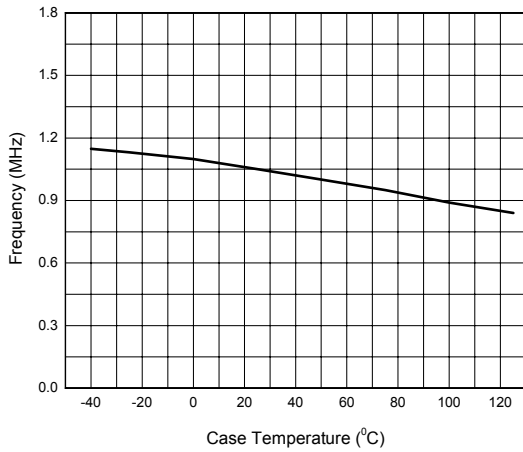

Figure 10. Frequency vs. Case Temperature

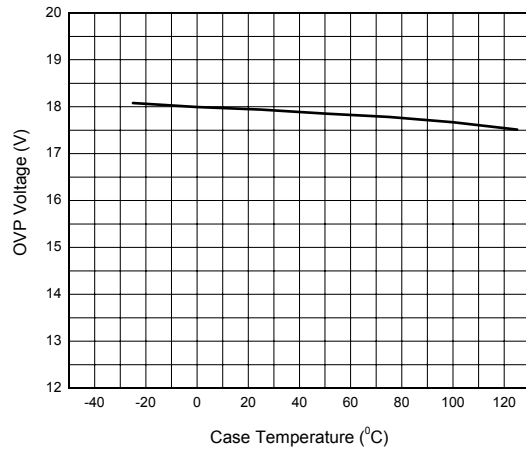

Figure 11. OVP Voltage vs. Case Temperature



**WHITE LED STEP-UP CONVERTER**

**AP3033**

**Typical Performance Characteristics (Continued)**

(WLED forward voltage ( $V_F$ )=3.2V at  $I_F$ =20mA, unless otherwise noted.)

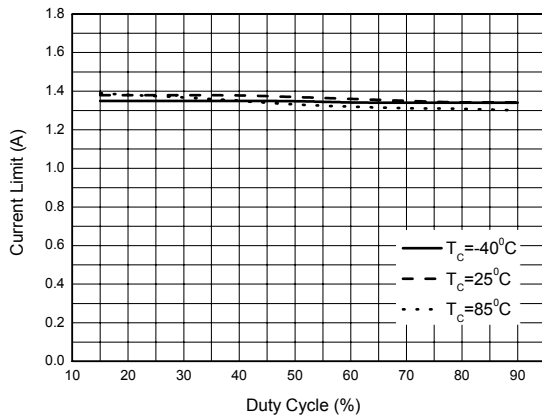

Figure 12. Current Limit vs. Duty Cycle



**WHITE LED STEP-UP CONVERTER**
**AP3033**
**Application Information**
**Operation**

The AP3033 is a boost DC-DC converter which uses a constant frequency, current mode control scheme to provide excellent line and load regulation. Operation can be best understood by referring to Figure 3 and Figure 17.

At the start of each oscillator cycle, switch Q1 turns on. The switch current will increase linearly. The voltage on sense resistor is proportional to the switch current. The output of the current sense amplifier is added to a stabilizing ramp and the result is fed into the non-inversion input of the PWM comparator A2. When this voltage exceeds the output voltage level of the error amplifier A1, the switch is turned off.

It is clear that the voltage level at inversion input of A2 sets the peak current level to keep the output in regulation. This voltage level is the output signal of error amplifier A1, and is the amplified signal of the voltage difference between feedback voltage and reference voltage of 200mV. So, a constant output current can be provided by this operation mode.

**LED Current Control**

Refer to Figure 17, the LED current is controlled by the feedback resistor  $R_{ISET}$ . LEDs' current accuracy is determined by the regulator's feedback threshold accuracy and is independent of the LED's forward voltage variation. So the precise resistors are preferred. The resistance of  $R_{ISET}$  is in inverse proportion to the LED current since the feedback reference is fixed at 200mV. The relation for  $R_{ISET}$  and LED current ( $I_{LED}$ ) can be expressed as below:

$$R_{ISET} = \frac{200mV}{I_{LED}}$$

**Over Voltage Protection**

The AP3033 has an internal open load protection circuit. When the LEDs are disconnected from circuit or fail open, the output voltage is clamped at about 17V. The AP3033 will switch at a low frequency, and minimize current to avoid input voltage drop.

**Soft Start**

The AP3033 has an internal soft start circuit to limit the inrush current during startup. If logic low time on CTRL pin is more than about 0.45ms and then enable the IC, the AP3033 will start smoothly to protect system departments. The time of startup is controlled by internal soft-start capacitor. Details please refer to Figure 13.

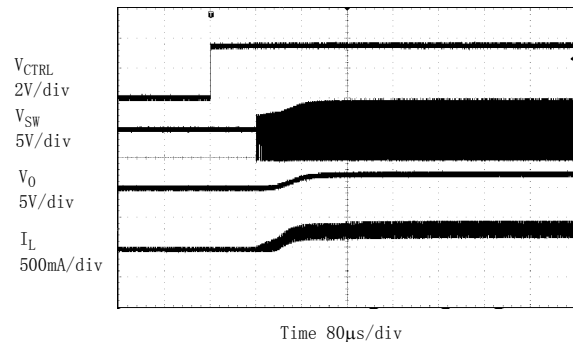

Figure 13. Soft-start Waveform  
 $V_{IN}=5V$ ,  $3 \times 8$  LEDs,  $I_{LED}=160mA$

**Dimming Control**

For controlling LED brightness, the AP3033 provides typically 200mV feedback voltage when the CTRL pin is pulled constantly high. However, CTRL pin allows a PWM signal to reduce this regulation voltage by changing the PWM duty cycle to achieve LED brightness dimming control. Detail circuit, as show in Figure 14. The relationship between the duty cycle and LED current can be expressed as below:

$$I_{LED} = \frac{200mV \times D_{PWM}}{R_{ISET}}$$

where  $D_{PWM}$  is the duty cycle of PWM signal and 200mV is internal reference voltage.

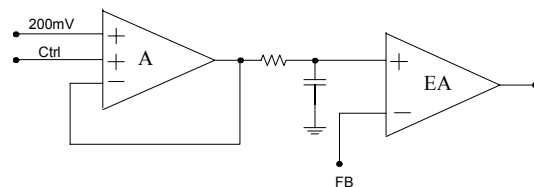

Figure 14. Block Diagram of Programmable FB Voltage Using PWM Signal

**WHITE LED STEP-UP CONVERTER**

**AP3033**

**Application Information (Continued)**

Two other typical types of dimming control circuit are presented as below.

**(1) Using DC Voltage to Change the Effective Feedback Voltage**

Adding a constant DC voltage through a resistor divider to FB pin can control the dimming. Changing the DC voltage or resistor between the FB Pin and the DC voltage can get appropriate luminous intensity. Comparing with all kinds of PWM signal control, this method features a stable output voltage and LEDs current. Please refer to Figure 15.

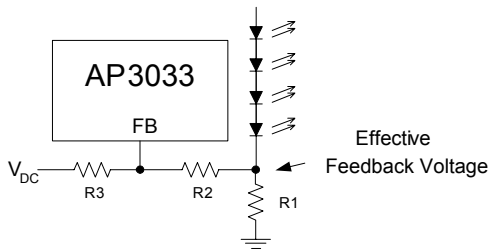

Figure 15. Dimming Control Using DC Voltage

**(2) Using Filtered PWM Signal to Change the Effective Feedback Voltage**

The filtered PWM signal can be considered as a varying and adjustable DC voltage, please refer to Figure 16.

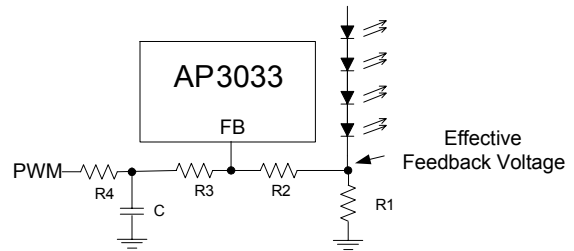

Figure 16. Dimming Control Using Filtered PWM Voltage

**Typical Application**

Figure 17. Typical Application of AP3033 (3S8P WLEDs)



**WHITE LED STEP-UP CONVERTER**

**AP3033**

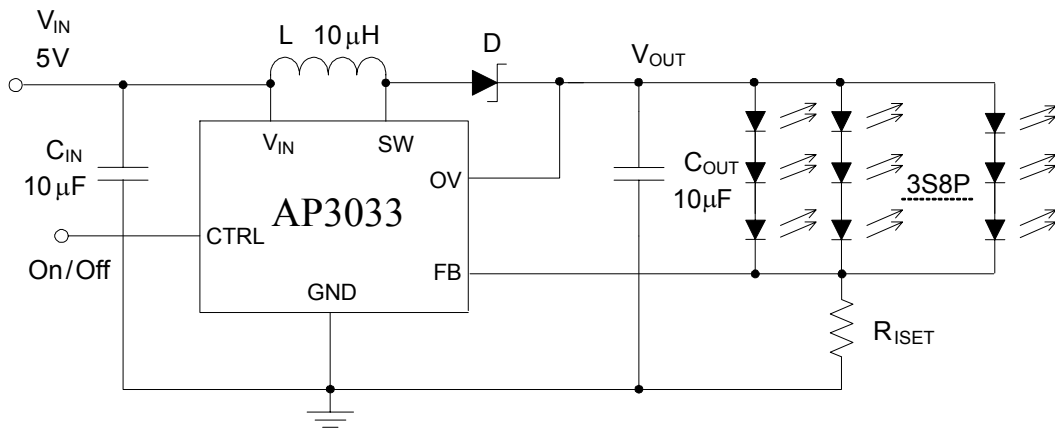
**Mechanical Dimensions**

**TSOT-23-6**

**Unit: mm(inch)**

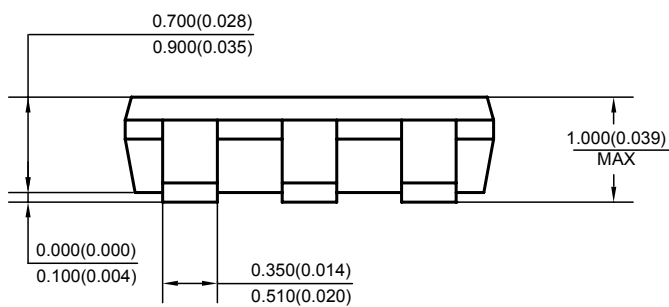
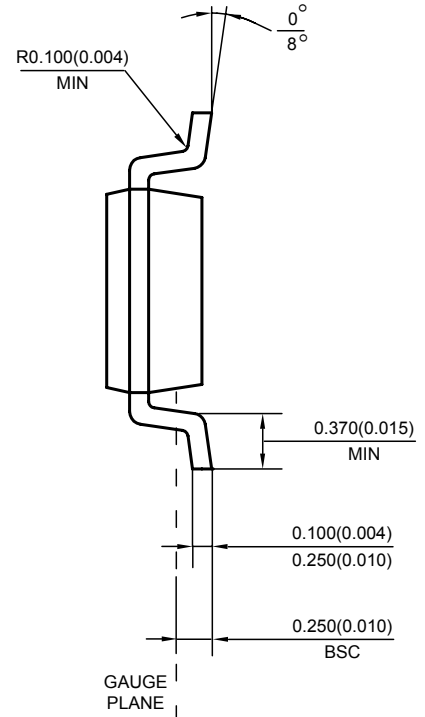
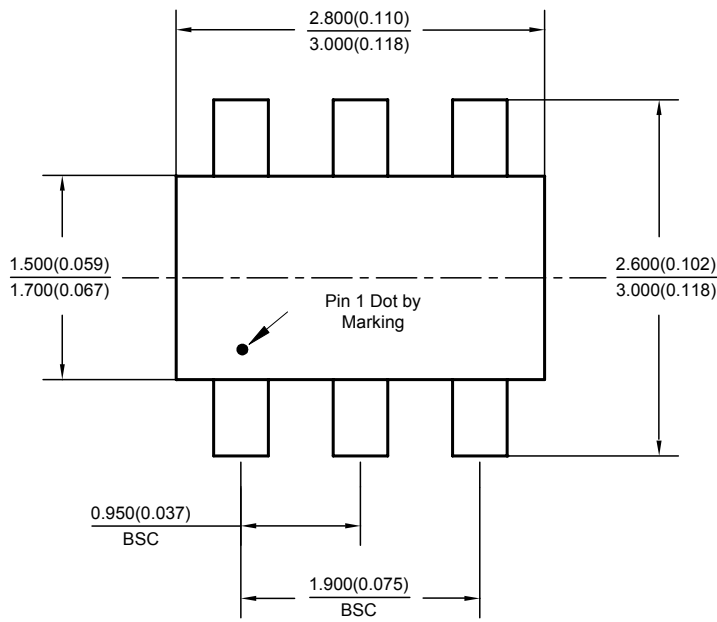



## **BCD Semiconductor Manufacturing Limited**

<http://www.bcdsemi.com>

### **IMPORTANT NOTICE**

BCD Semiconductor Manufacturing Limited reserves the right to make changes without further notice to any products or specifications herein. BCD Semiconductor Manufacturing Limited does not assume any responsibility for use of any its products for any particular purpose, nor does BCD Semiconductor Manufacturing Limited assume any liability arising out of the application or use of any its products or circuits. BCD Semiconductor Manufacturing Limited does not convey any license under its patent rights or other rights nor the rights of others.

---

#### **MAIN SITE**

##### **- Headquarters**

##### **BCD Semiconductor Manufacturing Limited**

No. 1600, Zi Xing Road, Shanghai ZiZhu Science-based Industrial Park, 200241, China  
Tel: +86-21-24162266, Fax: +86-21-24162277

##### **- Wafer Fab**

##### **Shanghai SIM-BCD Semiconductor Manufacturing Co., Ltd.**

800 Yi Shan Road, Shanghai 200233, China  
Tel: +86-21-6485 1491, Fax: +86-21-5450 0008

#### **REGIONAL SALES OFFICE**

##### **Shenzhen Office**

##### **Shanghai SIM-BCD Semiconductor Manufacturing Co., Ltd., Shenzhen Office**

Unit A Room 1203, Skyworth Bldg., Gaoxin Ave. 1.S., Nanshan District, Shenzhen, China  
Tel: +86-755-8826 7951  
Fax: +86-755-8826 7865

##### **Taiwan Office**

##### **BCD Semiconductor (Taiwan) Company Limited**

4F, 298-1, Rui Guang Road, Nei-Hu District, Taipei, Taiwan  
Tel: +886-2-2656 2808  
Fax: +886-2-2656 2806

##### **USA Office**

##### **BCD Semiconductor Corp.**

30920 Huntwood Ave. Hayward, CA 94544, USA  
Tel : +1-510-324-2988  
Fax: +1-510-324-2788