

## Description

The AP3429/A is a 2A step-down DC-DC converter. At heavy load, the constant frequency PWM control performs excellent stability and transient response. No external compensation components are required.

The AP3429/A supports a range of input voltages from 2.7V to 5.5V, allowing the use of a single Li+/Li- polymer cell, multiple Alkaline/NiMH cell, and other standard power sources. The output voltage is adjustable from 0.6V to the input voltage. The AP3429/A employs internal power switch and synchronous rectifier to minimize external part count and realize high efficiency. During shutdown, the input is disconnected from the output and the shutdown current is less than 1 $\mu$ A. Other key features include over-temperature and short circuit protection, and under-voltage lockout to prevent deep battery discharge.

The AP3429/A delivers 2A maximum output current while consuming only 90 $\mu$ A of no-load quiescent current. Ultra-low  $R_{DS(ON)}$  integrated MOSFETs and 100% duty cycle operation make the AP3429/A an ideal choice for high output voltage, high current applications which require a low dropout threshold.

The AP3429/A is available in TSOT25 package.

## Applications

- 5V or 3.3V Point of Load Conversion
- Telecom/Networking Equipment
- Set Top Boxes
- Storage Equipment
- Video Cards
- DDR Power Supply

- Notes:
1. No purposely added lead. Fully EU Directive 2002/95/EC (RoHS) & 2011/65/EU (RoHS 2) compliant.
  2. See [http://www.diodes.com/quality/lead\\_free.html](http://www.diodes.com/quality/lead_free.html) for more information about Diodes Incorporated's definitions of Halogen- and Antimony-free, "Green" and Lead-free.
  3. Halogen- and Antimony-free "Green" products are defined as those which contain <900ppm bromine, <900ppm chlorine (<1500ppm total Br + Cl) and <1000ppm antimony compounds.

## Pin Assignments

(Top View)

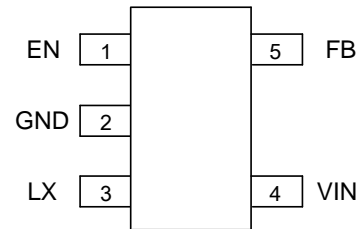

TSOT25

## Features

- Output Current: Up to 2A
- Output Voltage: 0.6V to  $V_{IN}$
- Input Voltage: 2.7V to 5.5V
- Shutdown Current: <1 $\mu$ A
- 100% Duty Cycle Operation
- 1MHz Switching Frequency
- Internal Soft Start
- No External Compensation Required
- Short Circuit Protection
  - AP3429: Latch Off Protection
  - AP3429A: Hiccup Mode Protection
- Over Voltage Protection
  - AP3429: Latch Off Protection
  - AP3429A: No Latch Off Protection
- Thermal Shutdown
- TSOT25 package
- **Totally Lead-Free & Fully RoHS Compliant (Notes 1 & 2)**
- **Halogen and Antimony Free. "Green" Device (Note 3)**

**Typical Applications Circuit**

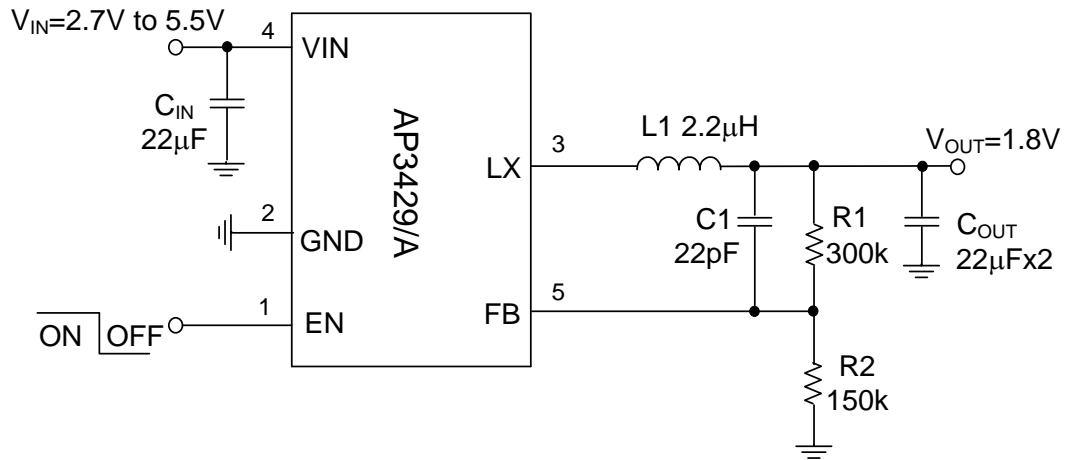

**Pin Descriptions**

Pin Number	Pin Name	Function
1	EN	Enable control input. Force this pin voltage above 1.5V enables the chip, and below 0.4V shuts down the device.
2	GND	Ground pin.
3	LX	The drains of the internal main and synchronous power MOSFETs.
4	VIN	Bias supply. Chip main power supply pin.
5	FB	Feedback voltage to internal error amplifier. The threshold voltage is 0.6V.

NEW PRODUCT

**Functional Block Diagram**

NEW PRODUCT

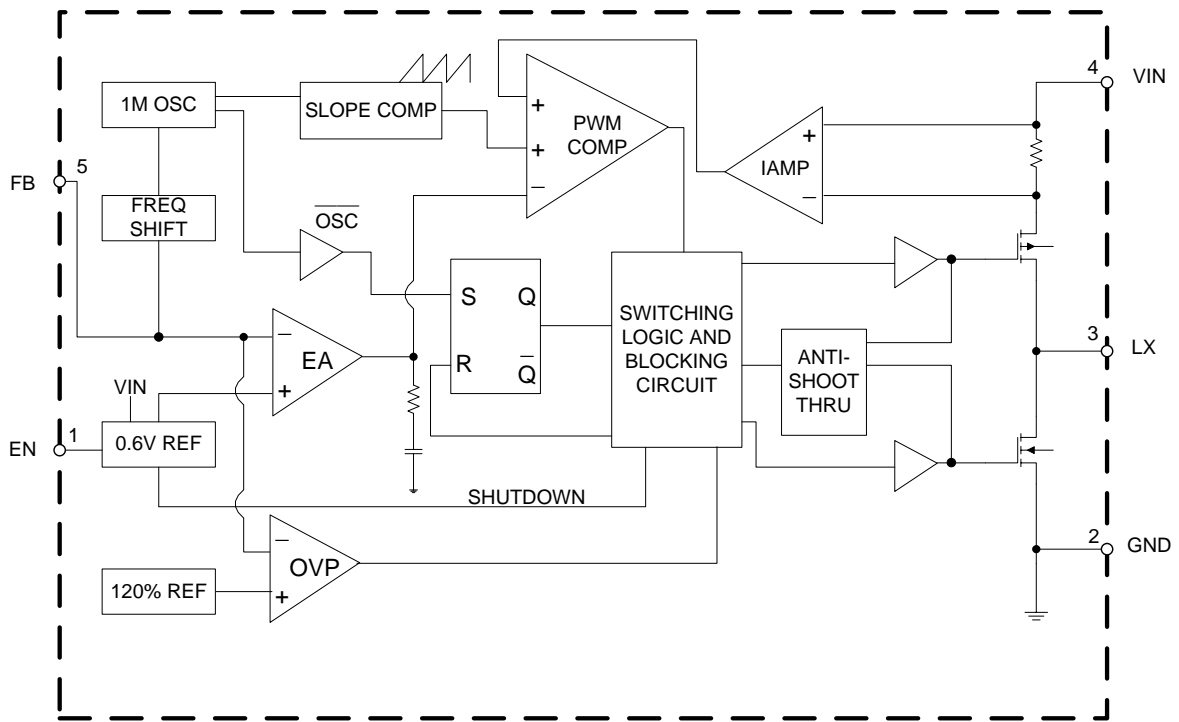

Function Block Diagram of AP3429

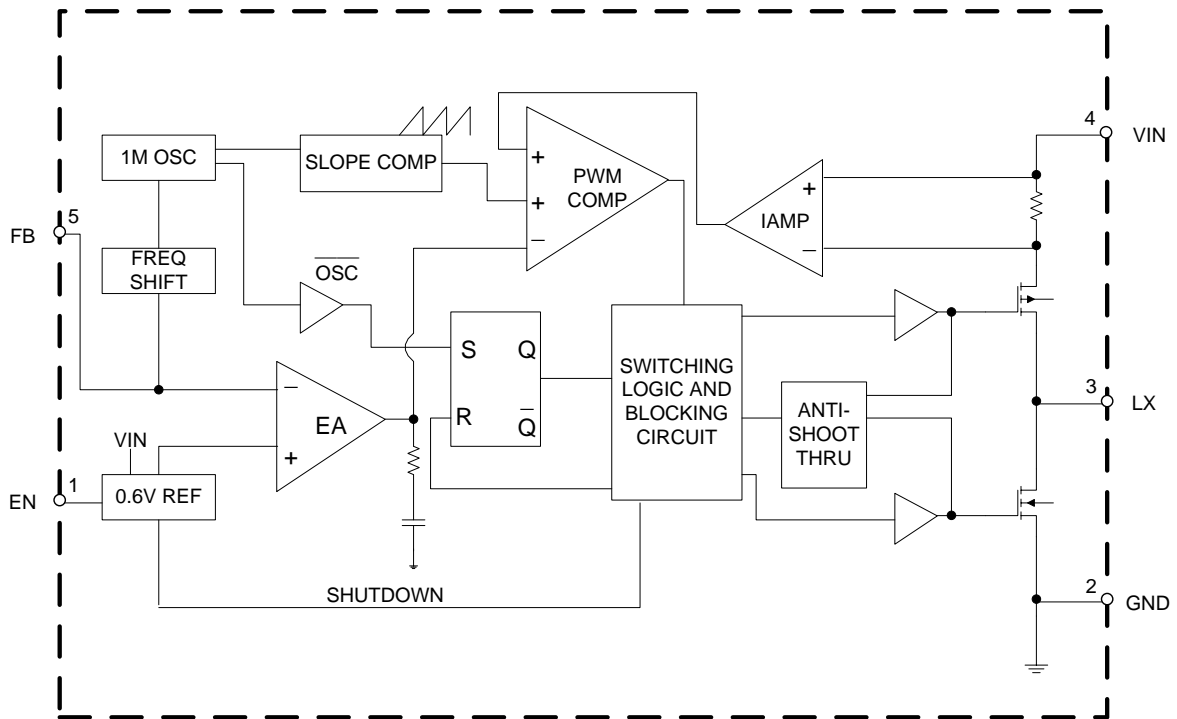

Function Block Diagram of AP3429A

**Absolute Maximum Ratings** (Note 4)

Symbol	Parameter	Rating	Unit
$V_{IN}$	Input Voltage	-0.3 to 6	V
$V_{EN}$	EN Pin Voltage	-0.3 to $V_{IN}+0.3$	V
$V_{LX}$	LX Pin Voltage	-0.3 to $V_{IN}+0.3$	V
$V_{FB}$	Feedback Pin Voltage	-0.3 to $V_{IN}+0.3$	V
$P_D$	Power Dissipation (on PCB, $T_A = +25^\circ\text{C}$ )	0.4	W
$\theta_{JA}$	Thermal Resistance (Junction to Ambient)	220	$^\circ\text{C/W}$
$\theta_{JC}$	Thermal Resistance (Junction to Case, Simulation)	130	$^\circ\text{C/W}$
$T_J$	Operating Junction Temperature	+150	$^\circ\text{C}$
$T_{STG}$	Storage Temperature	-55 to +150	$^\circ\text{C}$
$V_{MM}$	ESD (Machine Model)	200	V
$V_{HBM}$	ESD (Human Body Model)	2000	V

Note 4: Stresses greater than those listed under "Absolute Maximum Ratings" may cause permanent damage to the device. These are stress ratings only, and functional operation of the device at these or any other conditions beyond those indicated under "Recommended Operating Conditions" is not implied. Exposure to "Absolute Maximum Ratings" for extended periods may affect device reliability.

**Recommended Operating Conditions**

Symbol	Parameter	Min	Max	Unit
$V_{IN}$	Input Voltage Range	2.7	5.5	V
$T_A$	Operating Ambient Temperature	-40	+85	$^\circ\text{C}$
$T_J$	Junction Temperature Range	-40	+125	$^\circ\text{C}$

**Electrical Characteristics** (@ $V_{IN} = 5V$ ,  $V_{OUT} = 1.8V$ ,  $L = 2.2\mu H$ ,  $C_{IN} = 22\mu F$ ,  $C_{OUT} = 22\mu F \times 2$ ,  $T_A = +25^\circ C$ , unless otherwise specified.)

Symbol	Parameters	Conditions	Min	Typ	Max	Unit
$V_{IN}$	Input Voltage Range	–	2.7	–	5.5	V
$V_{FB}$	Regulated Feedback Voltage	–	0.588	0.6	0.612	V
$I_{FB}$	FB Leakage Current	$V_{FB} = 1V$	–	–	0.2	$\mu A$
$I_Q$	Quiescent Current	$V_{FB} = 0.65V$	–	90	–	$\mu A$
$I_{SD}$	Shutdown Current	$V_{EN} = 0V$	–	0.1	1	$\mu A$
$I_{LIM}$	Peak Inductor Current	–	3	–	–	A
$V_{SCP}$	Short Circuit Protection Latch Off Threshold	–	–	0.3	–	V
$f_{OSC}$	Oscillator Frequency	–	–	1	–	MHz
$R_{DS(ON)}$	Drain to Source On-state Resistance	$I_{LX} = 100mA$ , high side	–	110	–	m $\Omega$
		$I_{LX} = 100mA$ , low side	–	80	–	
$V_{ENH}$	EN High Threshold	–	1.5	–	–	V
$V_{ENL}$	EN Low Threshold	–	–	–	0.4	V
$I_{EN}$	EN Leakage Current	$V_{IN} = V_{EN} = 5V$	-1.0	–	1.0	$\mu A$
$V_{UVLO}$	Input UVLO Threshold	–	–	2.4	2.7	V
$V_{HYS}$	UVLO Hysteresis	–	–	0.2	–	V
–	Maximum Duty Cycle	–	100	–	–	%
$R_{DSCH}$	Output Discharge Switch On Resistance	–	–	50	–	$\Omega$
$T_{OTP}$	Over Temperature Protection	–	–	+160	–	$^\circ C$
$T_{OTH}$	OTP Hysteresis	–	–	+30	–	$^\circ C$
$V_{IOVP}$	$V_{IN}$ Over Voltage Protection	–	–	6.25	–	V
$V_{IHSY}$	IOVP Hysteresis	–	–	0.25	–	V
$t_{SS}$	Soft-start Time	–	–	1.8	–	ms

**Performance Characteristics** (@ $T_A = +25^\circ\text{C}$ ,  $V_{IN} = 5\text{V}$ ,  $V_{OUT} = 1.8\text{V}$ , unless otherwise specified.)

**Efficiency vs. Load Current**

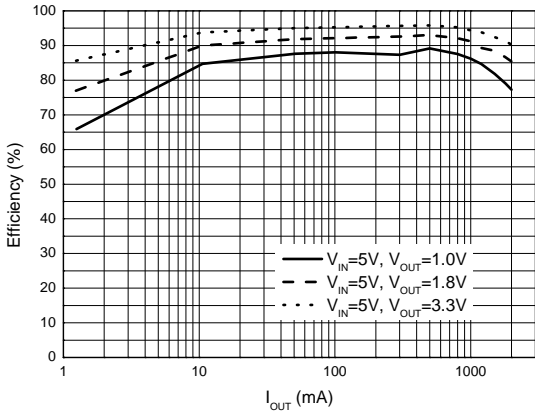

**Feedback Reference Voltage vs. Temperature**

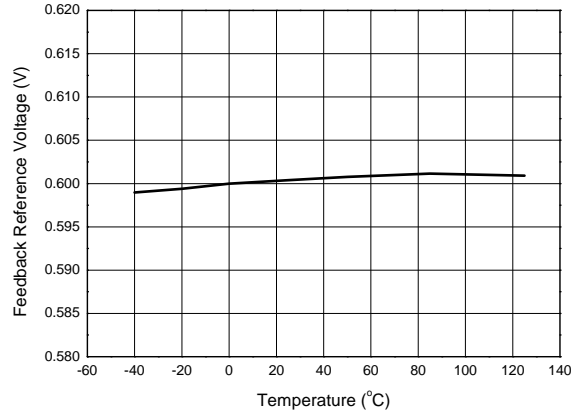

**PFET Drain-Source On-State Resistance vs. Temperature**

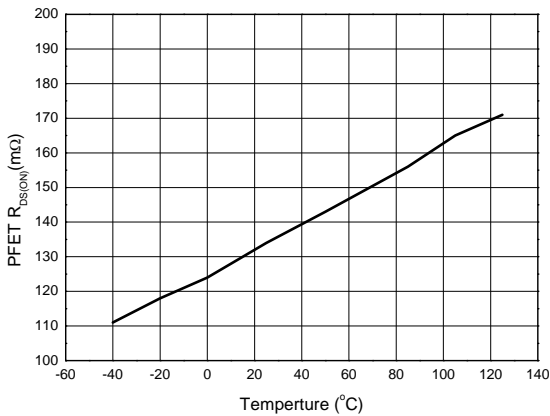

**NFET Drain-Source On-State Resistance vs. Temperature**

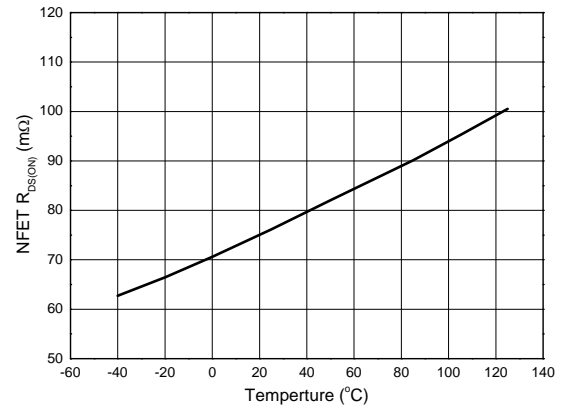

**Inductor Current Limit vs. Temperature**

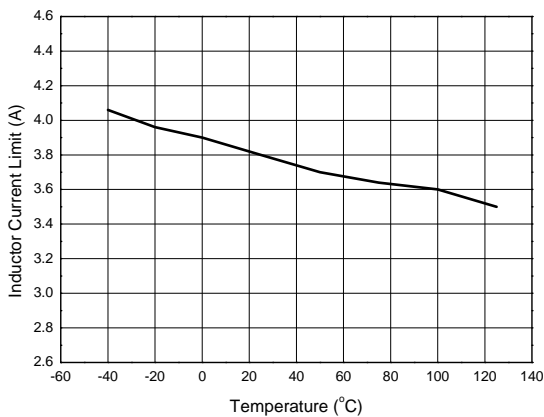

**Oscillation Frequency vs. Temperature**

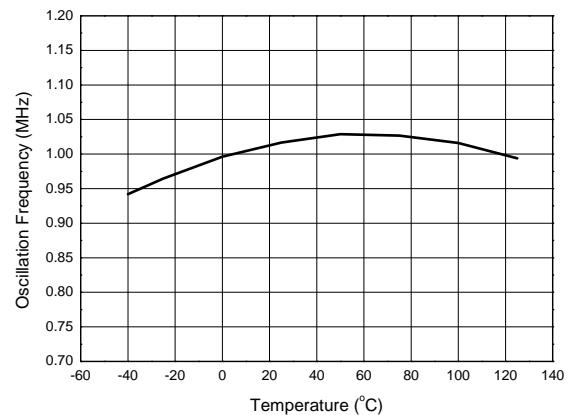

NEW PRODUCT

**Performance Characteristics** (Cont. @ $T_A = +25^\circ\text{C}$ ,  $V_{IN} = 5\text{V}$ ,  $V_{OUT} = 1.8\text{V}$ , unless otherwise specified.)

NEW PRODUCT

**Enable Turn on Characteristic ( $I_{OUT}=2\text{A}$ )**

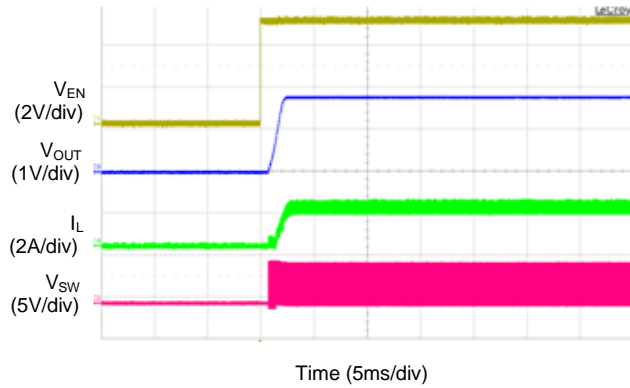

**Enable Turn off Characteristic ( $I_{OUT}=2\text{A}$ )**

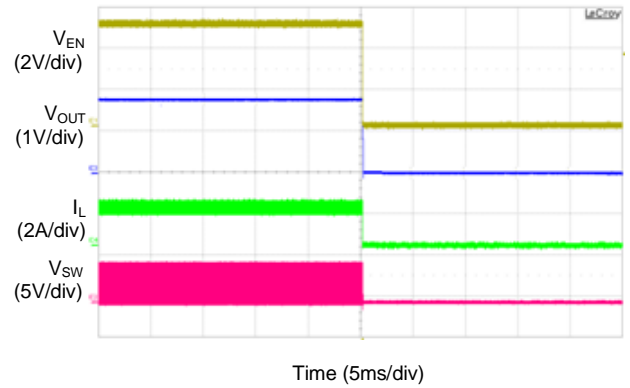

**Short Current Protection ( $I_{OUT}=2\text{A}$ )**

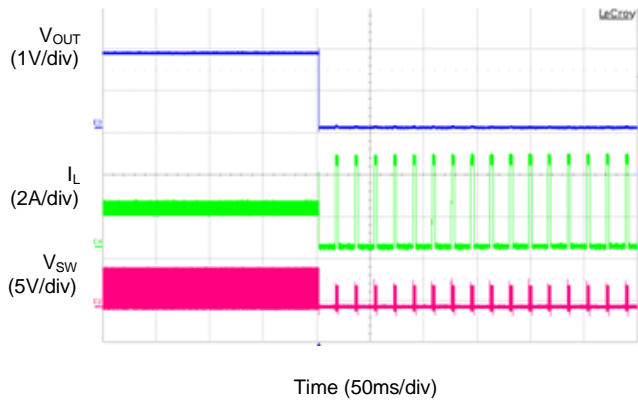

**SCP Recovery ( $I_{OUT}=2\text{A}$ )**

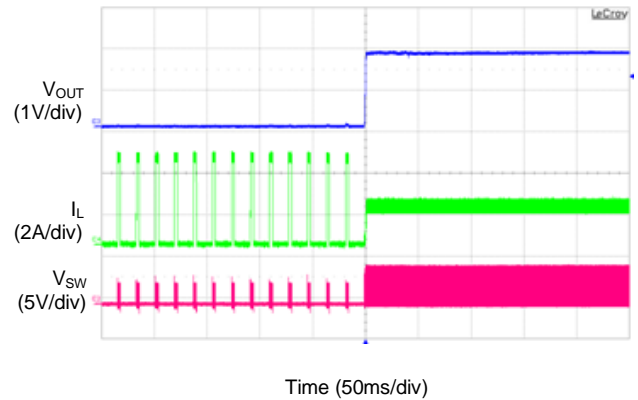

**Load Transient ( $I_{OUT}=0.1\text{A}$  to  $2\text{A}$ )**

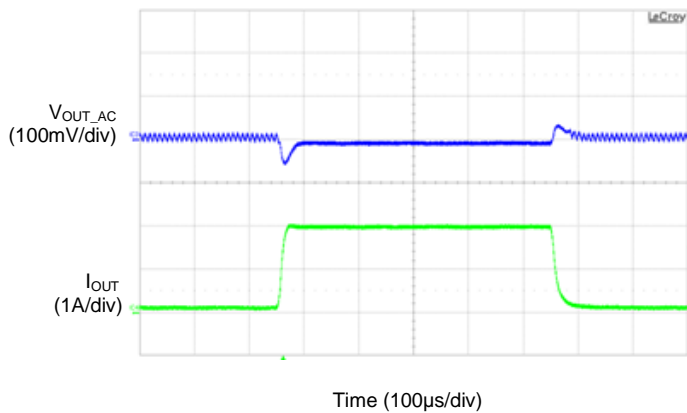

**Load Transient ( $I_{OUT}=1\text{A}$  to  $2\text{A}$ )**

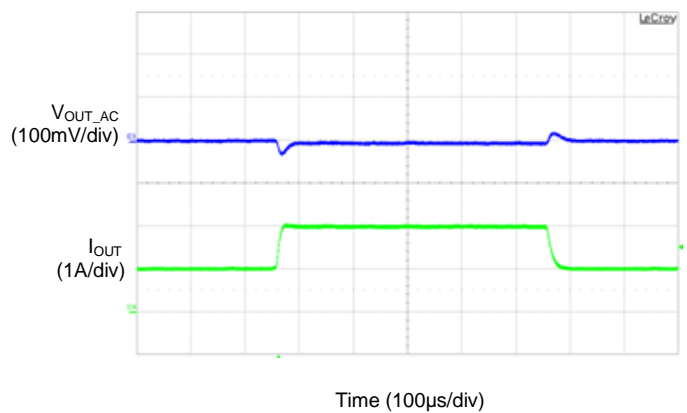

## Application Information

Typical application circuit is shown in the application circuit and for the circuit parameters setting please refers to the following descriptions.

### Under Voltage Lockout (UVLO) Circuit

The AP3429/A provides an under voltage lockout circuit to prevent it from undefined status. When the  $V_{IN}$  drops lower than the UVLO detector threshold, the UVLO circuit starts to operate,  $V_{REF}$  stops, and high-side and low-side built-in switch transistors turn "OFF". As a result,  $V_{OUT}$  drops according to the COU<sub>T</sub> capacitance value and the load. When the  $V_{IN}$  is rising higher than UVLO released voltage, the IC will restart the operation.

### Over Current Protection

The AP3429/A has internal over current protection function to protect from catastrophic failures. The IC can monitor the PMOS current, if the peak current is higher than the current limit threshold, OCP function will be triggered and enter cycle by cycle current limit mode. If  $V_{FB}$  drops under 0.3V for example, output node shorted to GND, AP3429 will enter latch off mode. IC will turn off both power switches. It will remain latch off state until the  $V_{IN}$  or Enable recycled to release it. AP3429A will enter hiccup mode to protect itself, if short circuit is removed, and  $V_{FB}$  rises over 0.3V, the AP3429A recovers to normal operation again.

### Over Voltage Protection

The AP3429 has internal output OVP circuits. When  $V_{OUT}$  is exceeds 120% of the regulation level for more than 40 $\mu$ s, the power switching will be turned off. IC enter latch off mode and will restart until  $V_{IN}$  or Enable voltage recycled.

### Over Temperature Protection

The internal thermal temperature protection circuitry of AP3429/A is provided to protect the integrated circuit in the event that the maximum junction temperature is exceeded. When the junction temperature exceeds +160°C, it shuts down the internal control circuit and switching power MOSFET. The AP3429/A will restart automatically under the control of soft start circuit when the junction temperature decreases to +130°C.

### Input Over Voltage Protection

When input voltage of AP3429/A is near 6.25V, the IC will enter Input-Over-Voltage-Protection. It would be shut down and there will be no output voltage in this state. As the input voltage goes down below 6V, it will leave input OVP and recover the output voltage.



**Ordering Information**

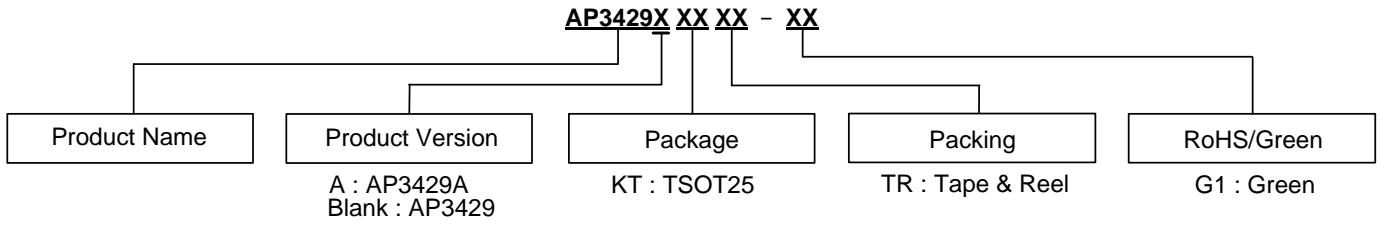

Package	Temperature Range	Part Number	Marking ID	Packing
TSOT25	-40 to +85°C	AP3429AKTTR-G1	L2E	3000/Tape & Reel
		AP3429KTTR-G1	L2F	3000/Tape & Reel

**Marking Information**

AP3429

(Top View)

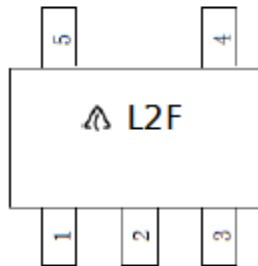

First Line: Logo and Marking ID

AP3429A

(Top View)

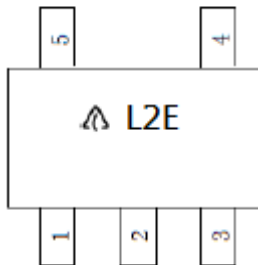

First Line: Logo and Marking ID

## Package Outline Dimensions

Please see AP02002 at <http://www.diodes.com/datasheets/ap02002.pdf> for the latest version.

### (1) Package Type: TSOT25

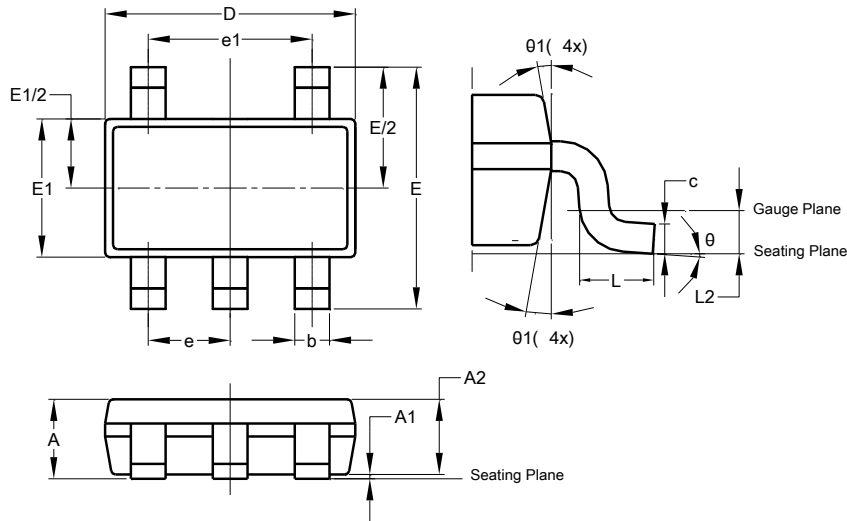

TSOT25			
Dim	Min	Max	Typ
A	-	1.00	-
A1	0.01	0.10	-
A2	0.84	0.90	-
b	0.30	0.45	-
c	0.12	0.20	-
D	-	-	2.90
E	-	-	2.80
E1	-	-	1.60
e	0.95 BSC		
e1	1.90 BSC		
L	0.30	0.50	
L2	0.25 BSC		
θ	0°	8°	4°
θ1	4°	12°	-
All Dimensions in mm			

## Suggested Pad Layout

Please see AP02001 at <http://www.diodes.com/datasheets/ap02001.pdf> for the latest version.

### (1) Package Type: TSOT25

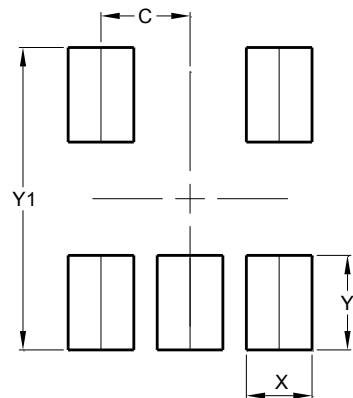

Dimensions	Value (in mm)
C	0.950
X	0.700
Y	1.000
Y1	3.199

**IMPORTANT NOTICE**

DIODES INCORPORATED MAKES NO WARRANTY OF ANY KIND, EXPRESS OR IMPLIED, WITH REGARDS TO THIS DOCUMENT, INCLUDING, BUT NOT LIMITED TO, THE IMPLIED WARRANTIES OF MERCHANTABILITY AND FITNESS FOR A PARTICULAR PURPOSE (AND THEIR EQUIVALENTS UNDER THE LAWS OF ANY JURISDICTION).

Diodes Incorporated and its subsidiaries reserve the right to make modifications, enhancements, improvements, corrections or other changes without further notice to this document and any product described herein. Diodes Incorporated does not assume any liability arising out of the application or use of this document or any product described herein; neither does Diodes Incorporated convey any license under its patent or trademark rights, nor the rights of others. Any Customer or user of this document or products described herein in such applications shall assume all risks of such use and will agree to hold Diodes Incorporated and all the companies whose products are represented on Diodes Incorporated website, harmless against all damages.

Diodes Incorporated does not warrant or accept any liability whatsoever in respect of any products purchased through unauthorized sales channel. Should Customers purchase or use Diodes Incorporated products for any unintended or unauthorized application, Customers shall indemnify and hold Diodes Incorporated and its representatives harmless against all claims, damages, expenses, and attorney fees arising out of, directly or indirectly, any claim of personal injury or death associated with such unintended or unauthorized application.

Products described herein may be covered by one or more United States, international or foreign patents pending. Product names and markings noted herein may also be covered by one or more United States, international or foreign trademarks.

This document is written in English but may be translated into multiple languages for reference. Only the English version of this document is the final and determinative format released by Diodes Incorporated.

**LIFE SUPPORT**

Diodes Incorporated products are specifically not authorized for use as critical components in life support devices or systems without the express written approval of the Chief Executive Officer of Diodes Incorporated. As used herein:

A. Life support devices or systems are devices or systems which:

1. are intended to implant into the body, or
2. support or sustain life and whose failure to perform when properly used in accordance with instructions for use provided in the labeling can be reasonably expected to result in significant injury to the user.

B. A critical component is any component in a life support device or system whose failure to perform can be reasonably expected to cause the failure of the life support device or to affect its safety or effectiveness.

Customers represent that they have all necessary expertise in the safety and regulatory ramifications of their life support devices or systems, and acknowledge and agree that they are solely responsible for all legal, regulatory and safety-related requirements concerning their products and any use of Diodes Incorporated products in such safety-critical, life support devices or systems, notwithstanding any devices- or systems-related information or support that may be provided by Diodes Incorporated. Further, Customers must fully indemnify Diodes Incorporated and its representatives against any damages arising out of the use of Diodes Incorporated products in such safety-critical, life support devices or systems.

Copyright © 2015, Diodes Incorporated

[www.diodes.com](http://www.diodes.com)