

Single Phase Synchronous Buck PWM Controller

AP3581A/B/C

General Description

The AP3581A/B/C is a compact synchronous-rectified buck controller specifically designed to operate from 5V/12V supply and deliver high-quality output voltage as low as 0.6V (AP3581A) or 0.8V (AP3581B/C). The AP3581A/B/C operates at fixed frequency of 300kHz (AP3581A/B) or 200kHz (AP3581C) and provides an optimal level of integration to reduce size and cost of the power supply.

This controller integrates internal MOSFET drivers that support 12V+12V bootstrapped voltage for high-efficiency power conversion. The bootstrap diode is built-in to simplify the circuit design and minimize external part count.

This controller provides single feedback loop, voltage-mode control with fast transient response. The error amplifier features a 10MHz gain-bandwidth product and 6V/ μ s slew rate which enables high converter bandwidth for fast transient performance.

Other features include internal soft-start, under voltage protection, over current protection and shutdown function. With afore-mentioned functions, this part provides customers a compact, high efficiency, well-protected and cost-effective solutions.

The AP3581A/B/C is available in PSOP-8 package.

Features

- Supply Voltage: 5V/12V
V_{IN} Input Range: 3.0V to 13.2V
0.6V/0.8V to 80% of V_{IN} Output Range
Internal Reference: 0.6V/0.8V
- Simple Single-loop Control
Voltage-mode PWM Control
Duty Cycle: 0% to 80%
Fast Transient Response
- 10MHz High-bandwidth Error Amplifier with 6V/ μ s Slew Rate
- Fixed Oscillator Frequency: 300kHz/200kHz
- Lossless, Programmable Over Current Protection (Uses Lower MOSFET R_{DS(ON)})
- Start-up into Pre-biased Output
- Built-in Thermal Shutdown
- Built-in Soft-start
- Over Current/Voltage Protection
- Under Voltage Protection
- Integrated Boot Diode

Applications

- Power Supplies for Microprocessors/Peripherals
PCs, Embedded Controllers, Memory Supplies
DSP and Core Communications Processor
Supplies
- Subsystem Power Supplies
PCI, AGP, Graphics Cards, Digital TV
SSTL-2 and DDR/2/3 SDRAM Bus Termination
Supply
- Cable Modems, Set Top Boxes, and DSL
Modems
- Industrial Power Supplies and General Purpose
Supplies
- 5V/12V Input DC-DC Regulators
- Low-voltage Distributed Power Supplies



Figure 1. Package Type of AP3581A/B/C

Single Phase Synchronous Buck PWM Controller
AP3581A/B/C
Pin Configuration

Figure 2. Pin Configuration of AP3581A/B/C (Top View)

Pin Description

Pin Number	Pin Name	Function
1	BOOT	Bootstrap pin. Connect a bootstrap capacitor (Typically from 0.1 μ F to 0.47 μ F) from this pin to PHASE pin to create a BOOT voltage suitable to drive a standard N-Channel MOSFET
2	UGATE	Upper-gate drive pin. Connect this pin to the upper MOSFET gate providing the gate drive. This pin is monitored by the adaptive shoot-through protection circuitry to determine when the upper MOSFET has been turned off
3	OPS	Over-current setting pin. Connecting a resistor (R_{OCSET}) between OPS and GND to set the over-current trigger point
4	LGATE	Lower-gate drive pin. Connect LGATE to the lower MOSFET gate providing the gate drive for the lower MOSFET. This pin is monitored by the adaptive shoot-through protection circuitry to determine when the lower MOSFET has turned off
5	VCC	Bias supply pin. Provides a 5V or 12V bias supply for the chip from this pin. The pin should be bypassed with a capacitor to GND
6	FB	Feedback pin. This pin is the inverting input of the internal error amplifier. Use FB pin, in combination with the COMP pin, to compensate the voltage control feedback loop of the converter. A resistor divider from output to GND is used to set the output voltage
7	COMP/EN	Compensation and disable pin, this pin is the output of the error amplifier. Pull COMP pin low will shut down the IC
8	PHASE	PHASE pin. This pin connects to the source of the upper MOSFET and the drain of the lower MOSFET. This pin is also monitored by the adaptive shoot-through protection circuitry to determine when the upper MOSFET has turned off
9	GND	Exposed pad as ground pin. Represents the signal and power ground for the IC. Tie this pin to the ground island/plane through the lowest impedance connection available

Single Phase Synchronous Buck PWM Controller

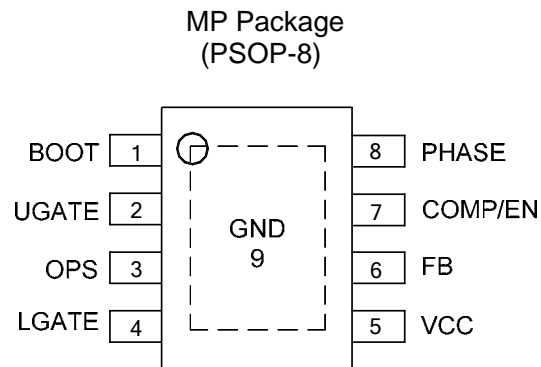
AP3581A/B/C

Functional Block Diagram

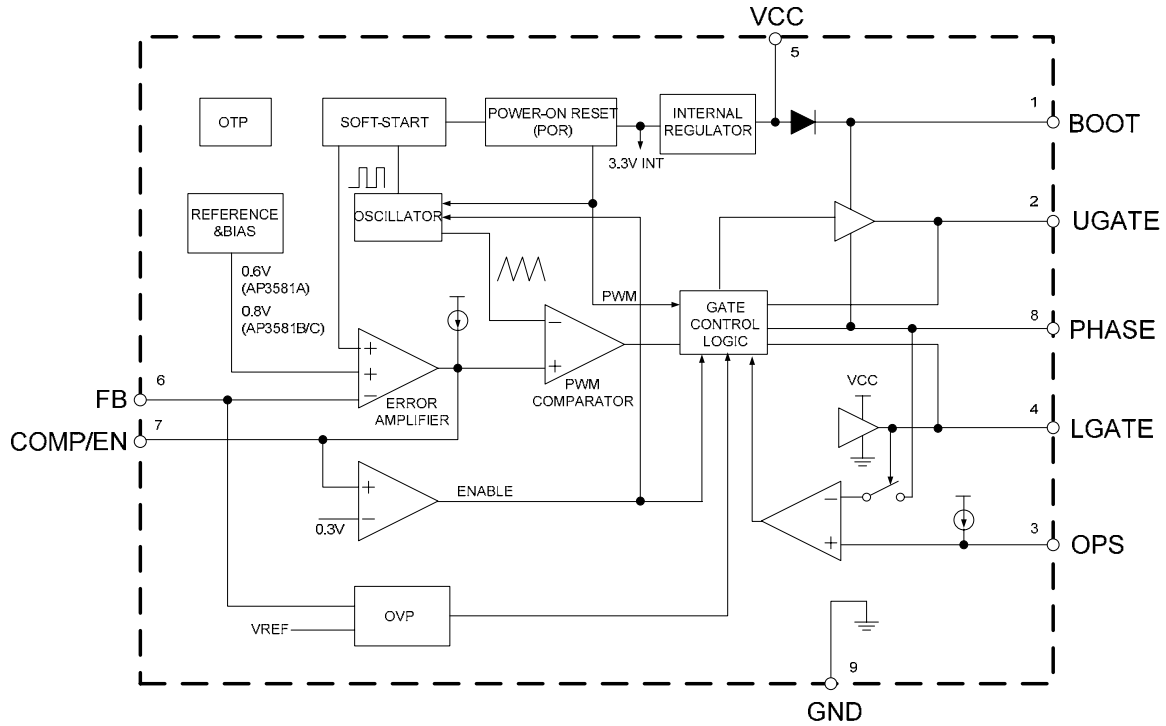
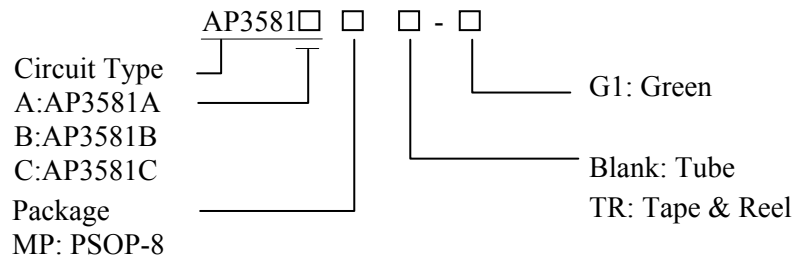

Figure 3. Functional Block Diagram of AP3581A/B/C

Ordering Information



Package	Temperature Range	Part Number	Marking ID	Packing Type
PSOP-8	-40 to 85°C	AP3581AMP-G1	3581AMP-G1	Tube
		AP3581AMPTR-G1	3581AMP-G1	Tape & Reel
		AP3581BMP-G1	3581BMP-G1	Tube
		AP3581BMPTR-G1	3581BMP-G1	Tape & Reel
		AP3581CMP-G1	3581CMP-G1	Tube
		AP3581CMPTR-G1	3581CMP-G1	Tape & Reel

BCD Semiconductor's Pb-free products, as designated with "G1" suffix in the part number, are RoHS compliant and green.

**Single Phase Synchronous Buck PWM Controller****AP3581A/B/C****Absolute Maximum Ratings (Note 1)**

Parameter	Symbol	Value	Unit
Supply Voltage	V_{CC}	-0.3 to 15	V
BOOT Voltage	V_{BOOT}	-0.3 to $V_{PHASE} +15$	V
Voltage from UGATE to PHASE	V_{UGATE}	-0.3 to 15	V
Voltage from PHASE, LGATE Pin to GND	V_{PHASE} , V_{LGATE}	-1 to 15	V
Voltage on Other Separate Pin		-0.3 to 6	V
Thermal Resistance	θ_{JA}	50	°C/W
Operating Junction Temperature	T_J	-40 to 125	°C
Storage Temperature	T_{STG}	-65 to 150	°C
Lead Temperature (Soldering, 10 sec)	T_{LEAD}	260	°C
ESD (Human Body Model) (Note 2)		2000	V
ESD (Machine Model) (Note 2)		200	V

Note 1: Stresses greater than those listed under “Absolute Maximum Ratings” may cause permanent damage to the device. These are stress ratings only, and functional operation of the device at these or any other conditions beyond those indicated under “Recommended Operating Conditions” is not implied. Exposure to “Absolute Maximum Ratings” for extended periods may affect device reliability.

Note 2: Devices are ESD sensitive. Handling precaution recommended.

Recommended Operating Conditions

Parameter	Symbol	Min	Max	Unit
Supply Input Voltage	V_{CC}	4.5	13.2	V
Operating Junction Temperature Range	T_J	-40	125	°C
Operating Ambient Temperature	T_A	-40	85	°C



Single Phase Synchronous Buck PWM Controller

AP3581A/B/C

Electrical Characteristics

$V_{CC}=12V$, $T_A=25^{\circ}C$, unless otherwise specified.

Parameter	Symbol	Conditions	Min	Typ	Max	Unit
SUPPLY INPUT						
Supply Voltage	V_{CC}		4.5		13.2	V
Supply Current	I_{CC}	UGATE and LGATE Pin Open; $V_{CC}=12V$, Switching		5		mA
Quiescent Supply Current	I_{CC_Q}	$V_{FB}=V_{REF}+0.1V$, No Switching		4		mA
Power Input Voltage	V_{IN}		3.0		13.2	V
POWER ON RESET						
V_{CC} Rising Threshold	V_{POR}	V_{CC} Rising	4.0	4.2	4.4	V
V_{CC} Threshold Hysteresis	V_{POR_HYS}			500		mV
OSCILLATOR						
Oscillator Frequency	f_{OSC}	AP3581A/B	270	300	330	kHz
		AP3581C	180	200	220	
Ramp Amplitude	ΔV_{OSC}	$V_{CC}=12V$		1.8		V
ERROR AMPLIFIER						
Open Loop DC Gain (Note 3)	G_{DC_OL}		55	70		dB
Gain Bandwidth (Note 3)	G_{BW}			10		MHz
Slew Rate (Note 3)	SR		3	6		V/ μ s
Transconductance				800	1100	μ A/V
Output Source Current		$V_{FB}<V_{REF}$	80	120		μ A
Output Sink Current		$V_{FB}>V_{REF}$	80	120		μ A
PWM CONTROLLER GATE DRIVERS						
Upper Gate Source Current	I_{UG_SRC}	$V_{BOOT}-V_{PHASE}=12V$, $V_{BOOT}-V_{UGATE}=6V$		-1		A
Upper Gate Sink Current	I_{UG_SNK}	$V_{BOOT}-V_{PHASE}=12V$, $V_{BOOT}-V_{UGATE}=6V$		1.5		A
Upper Gate Sink Resistance	R_{UGATE}	50mA Sink Current, $V_{BOOT}-V_{PHASE}=12V$		1.6	3.2	Ω
Lower Gate Source Current	I_{LG_SRC}	$V_{CC}-V_{LGATE}=6V$		-1		A
Lower Gate Sink Current	I_{LG_SNK}	$V_{LGATE}=6V$		1.5		A
Lower Gate Sink Resistance	R_{LGATE}	50mA Sink Current, $V_{CC}=12V$		1	2	Ω
PHASE Falling to LGATE Rising Delay		$V_{PHASE}<1.2V$ to $V_{LGATE}>1.2V$		50		ns

Single Phase Synchronous Buck PWM Controller

AP3581A/B/C

Electrical Characteristics (Continued)

$V_{CC}=12V, T_A=25^{\circ}C$, unless otherwise specified.

Parameter	Symbol	Conditions	Min	Typ	Max	Unit
LGATE Falling to UGATE Rising Delay		$V_{LGATE}<1.2V$ to $(V_{UGATE}-V_{PHASE})>1.2V$		50		ns
Minimum Duty Cycle				0		%
Maximum Duty Cycle			75	80	85	%
REFERENCE VOLTAGE						
Feedback Voltage	V_{FB}	AP3581A	0.591	0.6	0.609	V
		AP3581B/C	0.788	0.8	0.812	V
PROTECTION						
Under Voltage Protection	V_{FB_UVP}		0.3	0.4	0.5	V
Over Current Source	I_{OPS}		30	40	50	μA
Soft-start Interval	t_{SS}	AP3581A		2.0		ms
		AP3581B		2.7		
		AP3581C		3.6		
Enable Threshold	$V_{COMP/EN}$		0.25	0.30	0.35	V
Thermal Shutdown	T_{OTSD}			160		$^{\circ}C$
Thermal Shutdown Hysteresis	T_{HYS}			20		$^{\circ}C$

Note 3: Not tested, guaranteed by design.

Typical Performance Characteristics

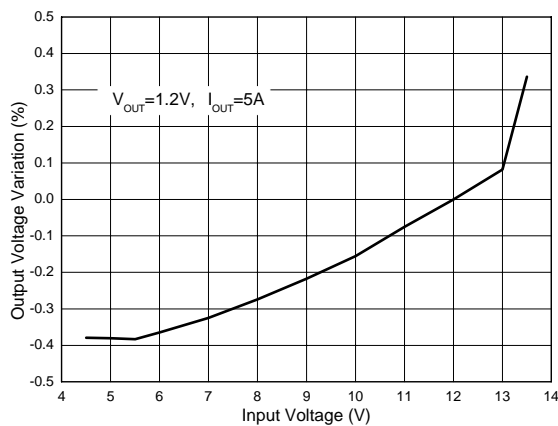

Figure 4. Line Regulation

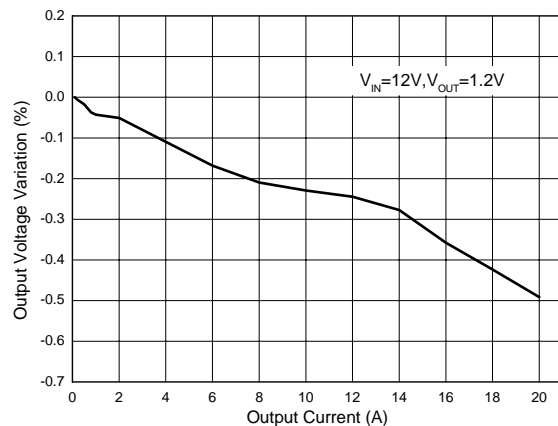

Figure 5. Load Regulation

Typical Performance Characteristics (Continued)

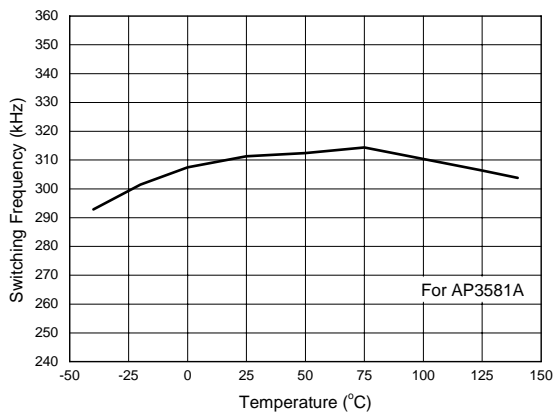

Figure 6. Switching Frequency vs. Temperature

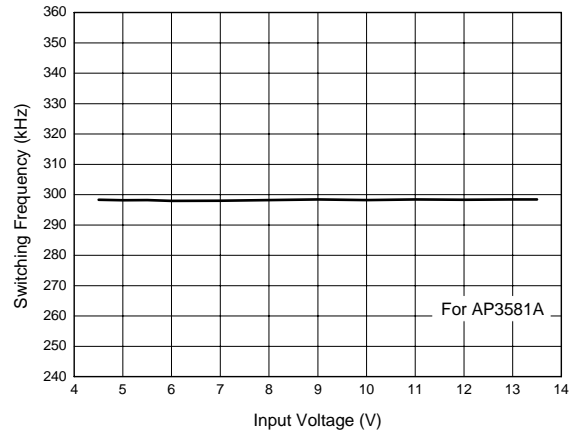

Figure 7. Switching Frequency vs. Input Voltage

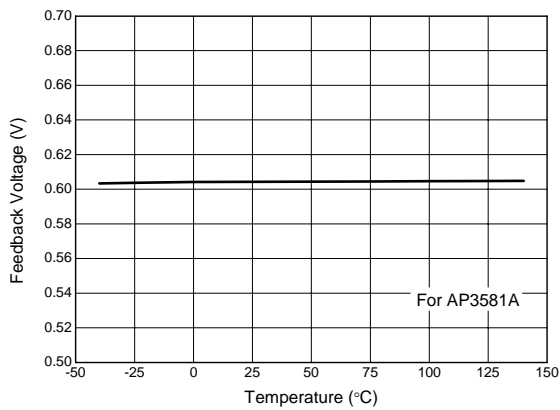

Figure 8. Feedback Voltage vs. Temperature

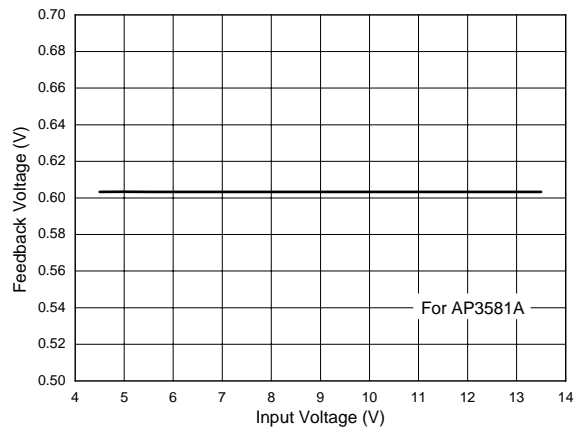
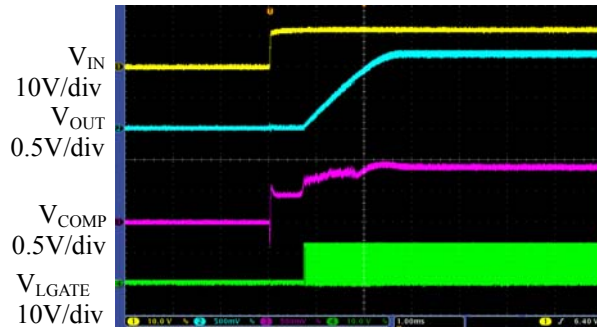
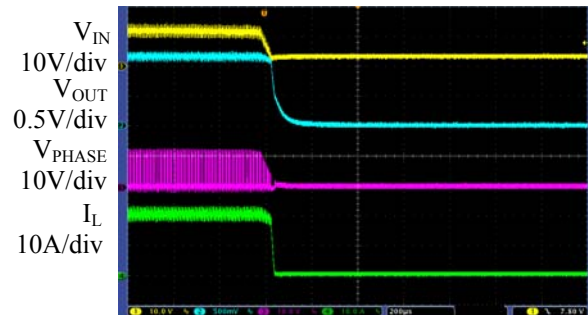

Figure 9. Feedback Voltage vs. Input Voltage

Single Phase Synchronous Buck PWM Controller
AP3581A/B/C
Typical Performance Characteristics (Continued)

Time 1ms/div

 Figure 10. Power-on Waveform
 ($V_{IN}=12V$, $V_{OUT}=1.2V$, $I_{OUT}=0A$)

Time 200µs/div

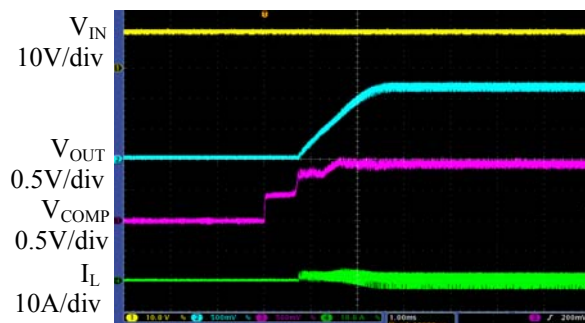
 Figure 11. Power-off Waveform
 ($V_{IN}=12V$, $V_{OUT}=1.2V$, $I_{OUT}=20A$)

Time 1ms/div

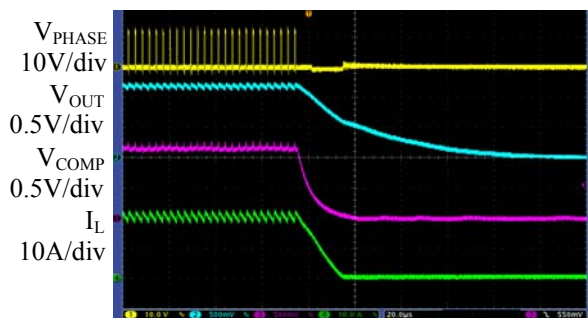
 Figure 12. Enable Waveform
 ($V_{IN}=12V$, $V_{OUT}=1.2V$, $I_{OUT}=0A$)

Time 20µs/div

 Figure 13. Disable Waveform
 ($V_{IN}=12V$, $V_{OUT}=1.2V$, $I_{OUT}=20A$)

Single Phase Synchronous Buck PWM Controller

AP3581A/B/C

Typical Performance Characteristics (Continued)

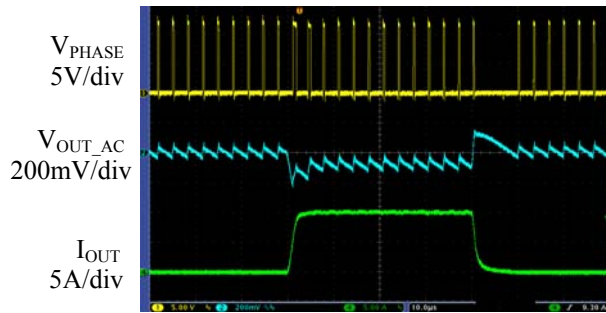

Time 10μs/div

Figure 14. Load Transient Response
(V_{IN}=12V, V_{OUT}=1.2V, I_{OUT}=0A to 10A)

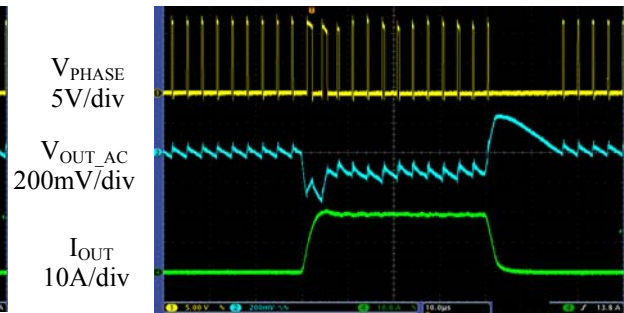

Time 10μs/div

Figure 15. Load Transient Response
(V_{IN}=12V, V_{OUT}=1.2V, I_{OUT}=0A to 20A)

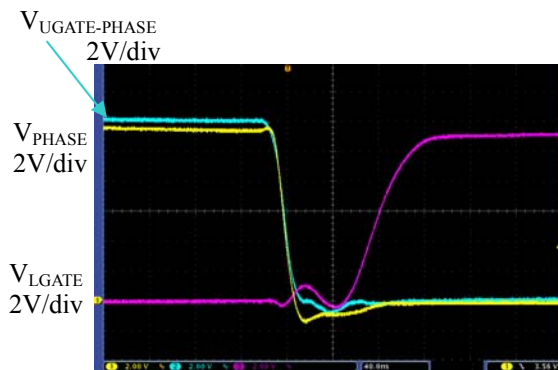

Time 40ns/div

Figure 16. UGATE Turn Off Waveforms
(V_{CC}=V_{IN}=12V, V_{OUT}=1.2V, I_{OUT}=20A)

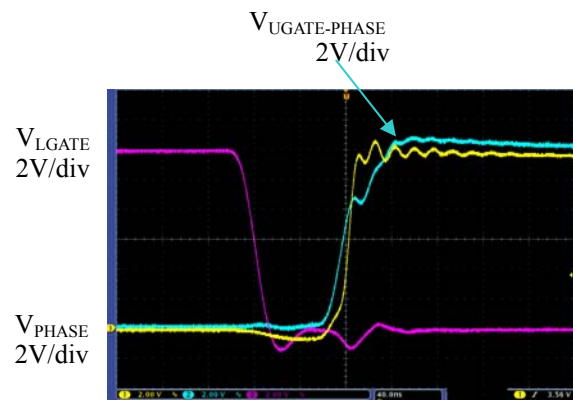

Time 40ns/div

Figure 17. UGATE Turn On Waveforms
(V_{CC}=V_{IN}=12V, V_{OUT}=1.2V, I_{OUT}=20A)

Typical Performance Characteristics (Continued)

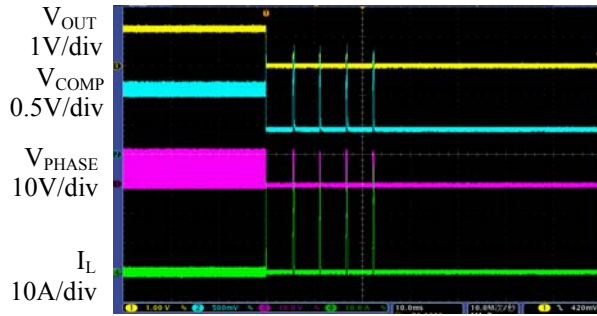

Time 10ms/div

Figure 18. Over Current Protection
($V_{IN}=12V$, $V_{OUT}=1.2V$ to $0V$, $I_{OUT}=0A$)

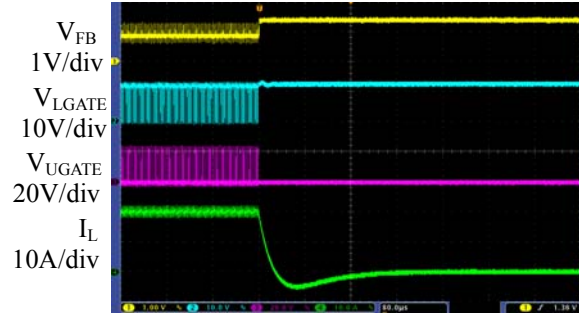

Time 80µs/div

Figure 19. Over Voltage Protection
($V_{IN}=12V$, $V_{OUT}=1.2V$, $I_{OUT}=20A$)

Single Phase Synchronous Buck PWM Controller
AP3581A/B/C
Typical Application

Figure 20. Typical Application Circuit of AP3581A/B/C

Mechanical Dimensions

PSOP-8

Unit: mm(inch)

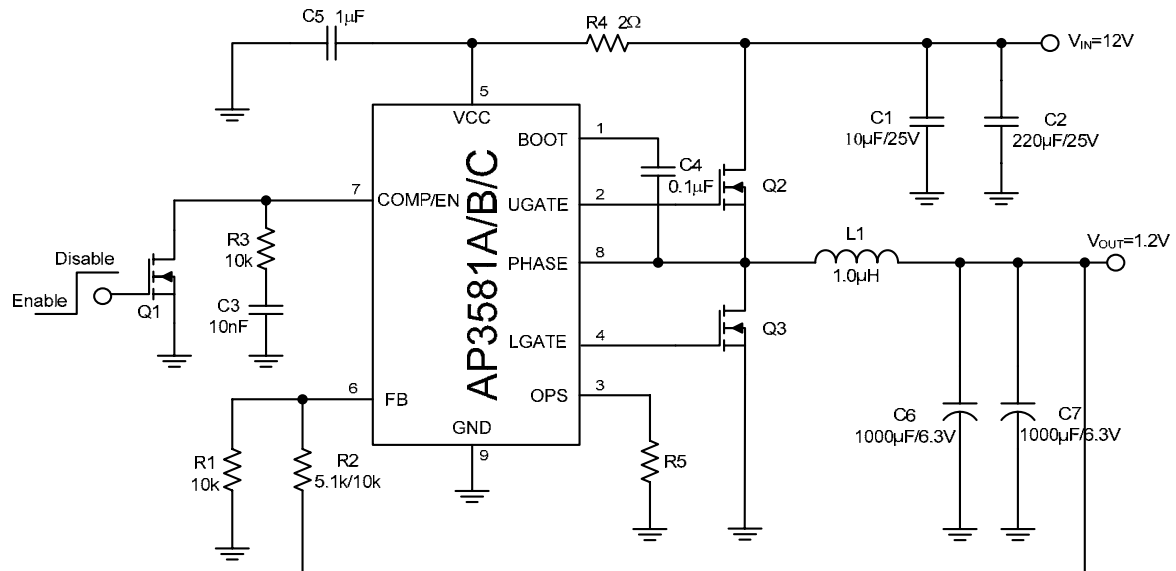
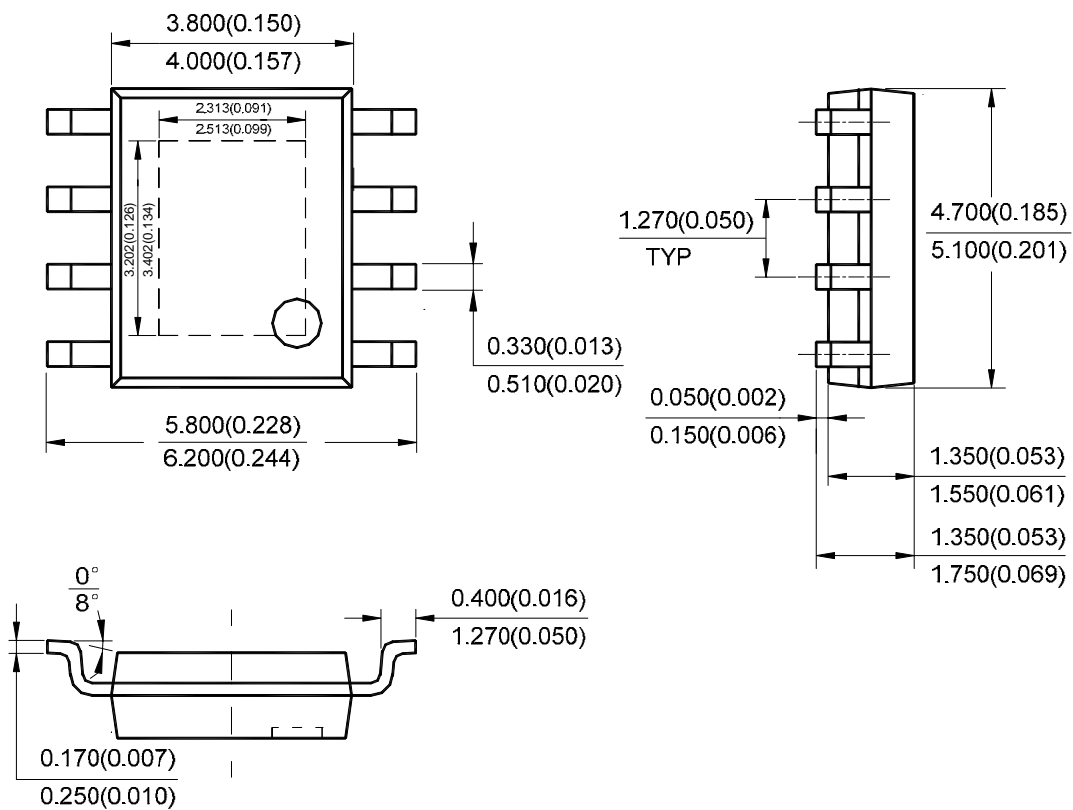

Note: Eject hole, oriented hole and mold mark is optional.



BCD Semiconductor Manufacturing Limited

<http://www.bcdsemi.com>

IMPORTANT NOTICE

BCD Semiconductor Manufacturing Limited reserves the right to make changes without further notice to any products or specifications herein. BCD Semiconductor Manufacturing Limited does not assume any responsibility for use of any its products for any particular purpose, nor does BCD Semiconductor Manufacturing Limited assume any liability arising out of the application or use of any its products or circuits. BCD Semiconductor Manufacturing Limited does not convey any license under its patent rights or other rights nor the rights of others.

MAIN SITE

- Headquarters

BCD Semiconductor Manufacturing Limited

No. 1600, Zi Xing Road, Shanghai ZiZhu Science-based Industrial Park, 200241, China
Tel: +86-21-24162266, Fax: +86-21-24162277

- Wafer Fab

Shanghai SIM-BCD Semiconductor Manufacturing Co., Ltd.

800 Yi Shan Road, Shanghai 200233, China
Tel: +86-21-6485 1491, Fax: +86-21-5450 0008

REGIONAL SALES OFFICE

Shenzhen Office

Shanghai SIM-BCD Semiconductor Manufacturing Co., Ltd., Shenzhen Office

Unit A Room 1203, Skyworth Bldg., Gaoxin Ave. 1.S., Nanshan District, Shenzhen, China
Tel: +86-755-8826 7951
Fax: +86-755-8826 7865

Taiwan Office

BCD Semiconductor (Taiwan) Company Limited

4F, 298-1, Rui Guang Road, Nei-Hu District, Taipei, Taiwan
Tel: +886-2-2656 2808
Fax: +886-2-2656 2806

USA Office

BCD Semiconductor Corp.

30920 Huntwood Ave. Hayward, CA 94544, USA
Tel : +1-510-324-2988
Fax: +1-510-324-2788