

Single Phase Synchronous Buck PWM Controller With Reference Input AP3583/A

General Description

The AP3583/A is a simple single-phase synchronous buck controller. It operates from 5V or 12V supply voltage and delivers high quality output voltage as low as 0.6V. This device operates at fixed 200kHz (AP3583) or 300kHz (AP3583A) frequency and provides an optimum compromise between efficiency, external component size and cost.

With integrated linear regulator bootstrap diode, and N-Channel MOSFET gate drives, the AP3583/A can reduce external component count and board space requirements.

The AP3583/A supports both tracking mode and stand-alone mode operation. The output voltage is tightly regulated to the external reference voltage from 0.4V to 3V at tracking mode or internal 0.6V reference at stand-alone mode.

Other features include internal soft-start, under voltage protection, over current protection and shutdown function. With aforementioned functions, this part provides customers a compact, high efficiency, well-protected and cost-effective solutions.

The AP3583/A is available in PSOP-8 package.

Features

- Supply Voltage: 5V/12V
V_{IN} Input Range: 3.0V to 13.2V
0.6V to 80% of V_{IN} Output Range
Internal Reference: 0.6V
- Support Tracking Mode and Stand-alone Mode
- Simple Single-loop Control
Voltage-mode PWM Control
Duty Cycle: 0% to 80%
- Fast Transient Response
- Fixed Oscillator Frequency: 200/300kHz
- Lossless, Programmable Over Current Protection (Uses Lower MOSFET R_{DS(ON)})
- Start-up into Pre-biased Output
- Built-in Thermal Shutdown
- Built-in Soft-start
- Over Current/Voltage Protection
- Under Voltage Protection
- Integrated Boot Diode

Applications

- Power Supplies for Microprocessors/Peripherals
PCs, Embedded Controllers, Memory Supplies
DSP and Core Communications Processor
Supplies
- Subsystem Power Supplies
PCI, AGP, Graphics Cards and Digital TV
SSTL-2 and DDR/2/3 SDRAM Bus Termination
Supply
- Cable Modems, Set Top Boxes, and DSL
Modems
- Industrial Power Supplies and General Purpose
Supplies
- 5V/12V Input DC-DC Regulators
- Low-voltage Distributed Power Supplies



Figure 1. Package Type of AP3583/A

Single Phase Synchronous Buck PWM Controller With Reference Input AP3583/A

Pin Configuration

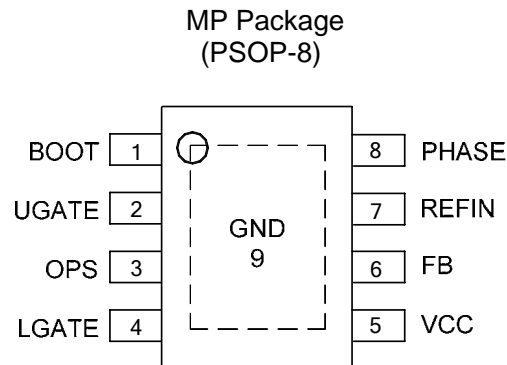

Figure 2. Pin Configuration of AP3583/A (Top View)

Pin Description

Pin Number	Pin Name	Function
1	BOOT	Bootstrap pin. Connect a bootstrap capacitor (Typically from 0.1 to 0.47 μ F) from this pin to PHASE pin to create a BOOT voltage suitable to drive a standard N-Channel MOSFET
2	UGATE	Upper-gate drive pin. Connect this pin to the upper MOSFET gate providing the gate drive. This pin is monitored by the adaptive shoot-through protection circuitry to determine when the upper MOSFET has been turned off
3	OPS	Over-current setting pin. Connecting a resistor (R_{OCSET}) between OPS and GND to set the over-current trigger point
4	LGATE	Lower-gate drive pin. Connect LGATE to the lower MOSFET gate providing the gate drive for the lower MOSFET. This pin is monitored by the adaptive shoot-through protection circuitry to determine when the lower MOSFET has been turned off
5	VCC	Bias supply pin. Provides a 5V or 12V bias supply for the chip from this pin. The pin should be bypassed with a capacitor to GND
6	FB	Feedback pin. This pin is the inverting input of the internal error amplifier. A resistor divider from output to GND is used to set the output voltage
7	REFIN	External reference input pin. This pin receives a voltage with range from 0.4V to 3.0V as the reference voltage at the non-inverting input of the error amplifier. Pull this pin lower than 0.3V to disable the controller, and the V_{UGATE} and V_{LGATE} will go low. Let this pin open for internal 0.6V reference use
8	PHASE	PHASE pin. This pin connects to the source of the upper MOSFET and the drain of the lower MOSFET. This pin is also monitored by the adaptive shoot-through protection circuitry to determine when the upper MOSFET is turned off
9	GND	Exposed pad as ground pin. Represents the signal and power ground for the IC. Tie this pin to ground island/plane through the lowest impedance connection available

Single Phase Synchronous Buck PWM Controller With Reference Input AP3583/A

Functional Block Diagram

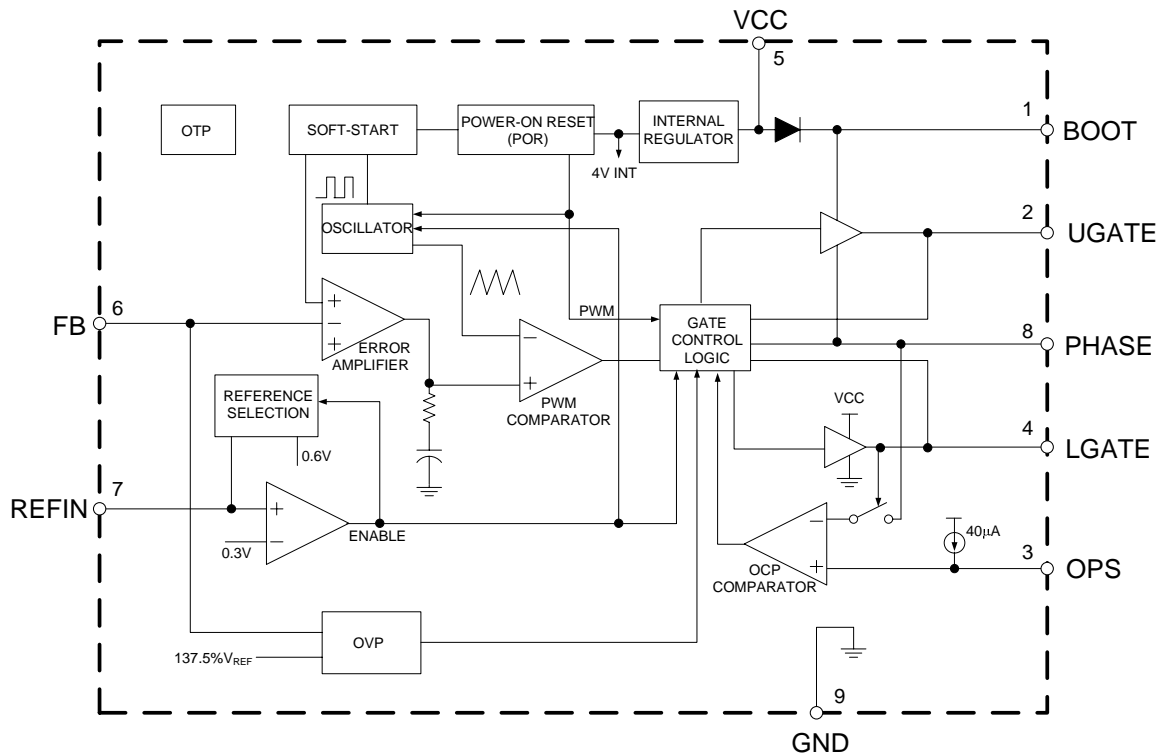
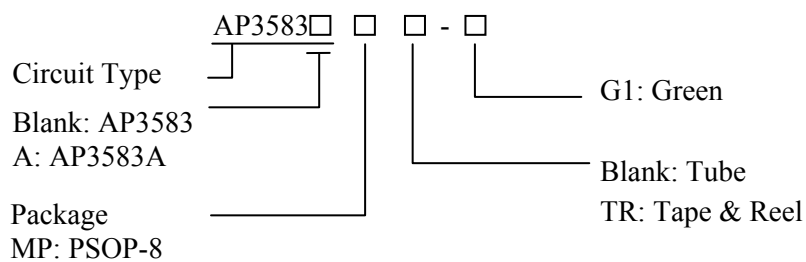

Figure 3. Functional Block Diagram of AP3583/A

Ordering Information



Package	Temperature Range	Part Number	Marking ID	Packing Type
PSOP-8	-40 to 85°C	AP3583MP-G1	3583MP-G1	Tube
		AP3583MPTR-G1	3583MP-G1	Tape & Reel
		AP3583AMP-G1	3583AMP-G1	Tube
		AP3583AMPTR-G1	3583AMP-G1	Tape & Reel

BCD Semiconductor's Pb-free products, as designated with "G1" suffix in the part number, are RoHS compliant and green.

**Single Phase Synchronous Buck PWM Controller With Reference Input AP3583/A****Absolute Maximum Ratings (Note 1)**

Parameter	Symbol	Value	Unit
Supply Voltage	V_{CC}	-0.3 to 15	V
BOOT Voltage	V_{BOOT}	-0.3 to $V_{PHASE} +15$	V
Voltage from UGATE to PHASE	V_{UGATE}	-0.3 to 15	V
Voltage from PHASE, LGATE Pin to GND	V_{PHASE} , V_{LGATE}	-1 to 15	V
Voltage on Other Separate Pin		-0.3 to 6	V
Thermal Resistance	θ_{JA}	50	°C/W
Operating Junction Temperature	T_J	-40 to 125	°C
Storage Temperature	T_{STG}	-65 to 150	°C
Lead Temperature (Soldering, 10 sec)	T_{LEAD}	260	°C
ESD (Human Body Model) (Note 2)		2000	V
ESD (Machine Model) (Note 2)		200	V

Note 1: Stresses greater than those listed under “Absolute Maximum Ratings” may cause permanent damage to the device. These are stress ratings only, and functional operation of the device at these or any other conditions beyond those indicated under “Recommended Operating Conditions” is not implied. Exposure to “Absolute Maximum Ratings” for extended periods may affect device reliability.

Note 2: Devices are ESD sensitive. Handling precaution recommended.

Recommended Operating Conditions

Parameter	Symbol	Min	Max	Unit
Supply Input Voltage	V_{CC}	4.5	13.2	V
Operating Junction Temperature	T_J	-40	125	°C
Operating Ambient Temperature	T_A	-40	85	°C



Single Phase Synchronous Buck PWM Controller With Reference Input AP3583/A

Electrical Characteristics

V_{CC}=12V, T_A=25°C, unless otherwise specified.

Parameter	Symbol	Conditions	Min	Typ	Max	Unit
SUPPLY INPUT						
Supply Voltage	V _{CC}		4.5		13.2	V
Supply Current	I _{CC}	UGATE and LGATE Pin Open; V _{CC} =12V, Switching		3		mA
Quiescent Supply Current	I _{CC_Q}	V _{FB} =V _{REF} +0.1V, No Switching		2		mA
Power Input Voltage	V _{IN}		3.0		13.2	V
POWER ON RESET						
V _{CC} Rising Threshold	V _{POR}	V _{CC} Rising	4.0	4.2	4.4	V
V _{CC} Threshold Hysteresis	V _{POR_HYS}			300		mV
OSCILLATOR						
Oscillator Frequency	f _{OSC}	AP3583	180	200	220	kHz
		AP3583A	270	300	330	
Ramp Amplitude	ΔV _{OSC}	V _{CC} =12V		1.0		V
PWM CONTROLLER GATE DRIVERS						
Upper Gate Source Current	I _{UG_SRC}	V _{BOOT} -V _{PHASE} =12V, V _{BOOT} -V _{UGATE} =6V		-1		A
Upper Gate Sink Current	I _{UG_SNK}	V _{BOOT} -V _{PHASE} =12V, V _{BOOT} -V _{UGATE} =6V		1.5		A
Upper Gate Sink Resistance	R _{UGATE}	50mA Sink Current V _{BOOT} -V _{PHASE} =12V		1.6	3.2	Ω
Lower Gate Source Current	I _{LG_SRC}	V _{CC} -V _{LGATE} =6V		-1		A
Lower Gate Sink Current	I _{LG_SNK}	V _{LGATE} =6V		1.5		A
Lower Gate Sink Resistance	R _{LGATE}	V _{CC} =12V, 50mA Source Current		1	2	Ω
PHASE Falling to LGATE Rising Delay		V _{PHASE} <1.2V to V _{LGATE} >1.2V		50		ns
LGATE Falling to UGATE Rising Delay		V _{LGATE} <1.2V to (V _{UGATE} -V _{PHASE})>1.2V		50		ns
Minimum Duty Cycle				0		%
Maximum Duty Cycle			75	80	85	%
REFERENCE VOLTAGE						
Feedback Voltage	V _{FB}	Stand-alone Mode	0.591	0.6	0.609	V

Single Phase Synchronous Buck PWM Controller With Reference Input AP3583/A

Electrical Characteristics (Continued)

$V_{CC}=12V$, $T_A=25^{\circ}C$, unless otherwise specified.

Parameter	Symbol	Conditions	Min	Typ	Max	Unit
Output Voltage Accuracy		$ V_{FB}-V_{REFIN} $, V_{REFIN} =0.4V to 1.0V, Tracking Mode			15	mV
		$ V_{FB}-V_{REFIN} /V_{REFIN}$, $V_{REFIN}=1.0V$ to 3.0V, Tracking Mode			1.5	%
REFIN Enable Threshold	V_{REFIN}			0.3	0.35	V
PROTECTION						
Under Voltage Protection	V_{FB_UVP}		0.3	0.4	0.5	V
Over Current Source	I_{OPS}		30	40	50	μA
Soft-start Interval	t_{SS}	AP3583, Stand-alone Mode		2.6		ms
		AP3583A, Stand-alone Mode		2.0		
Thermal Shutdown	T_{OTSD}			160		$^{\circ}C$
Thermal Shutdown Hysteresis	T_{HYS}			20		$^{\circ}C$

Typical Performance Characteristics

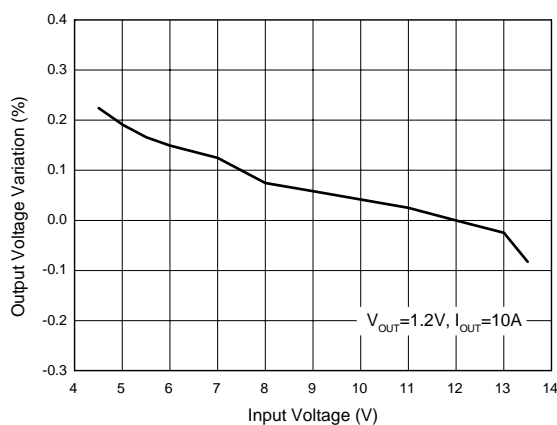

Figure 4. Line Regulation

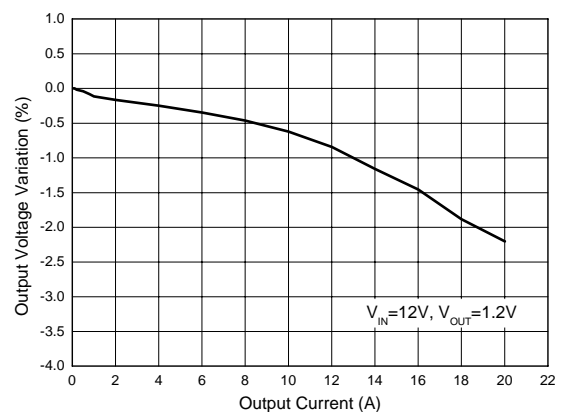

Figure 5. Load Regulation

Single Phase Synchronous Buck PWM Controller With Reference Input AP3583/A

Typical Performance Characteristics (Continued)

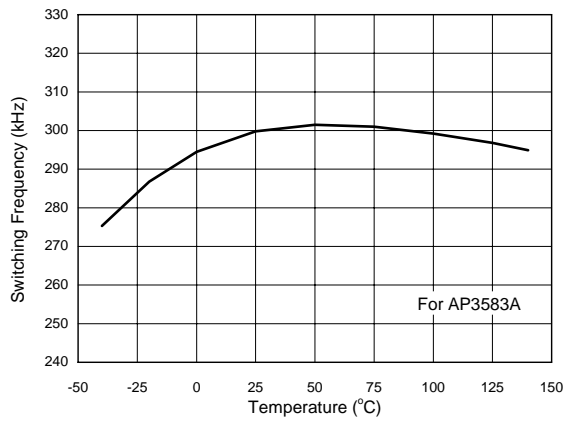

Figure 6. Switching Frequency vs. Temperature

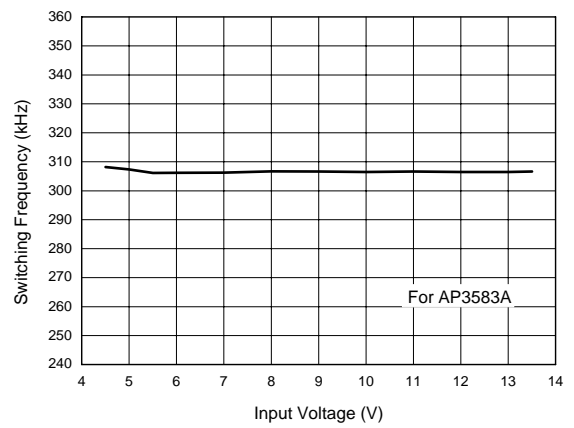

Figure 7. Switching Frequency vs. Input Voltage

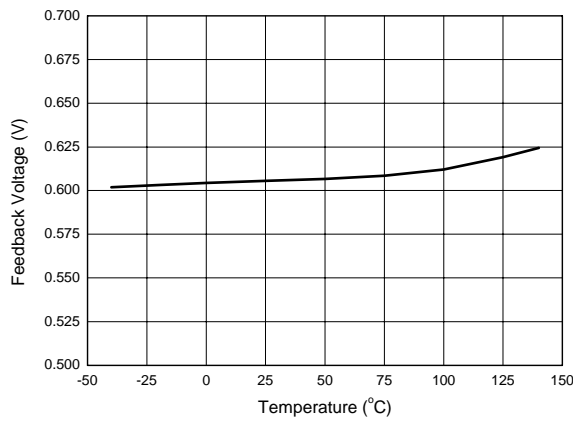

Figure 8. Feedback Voltage vs. Temperature

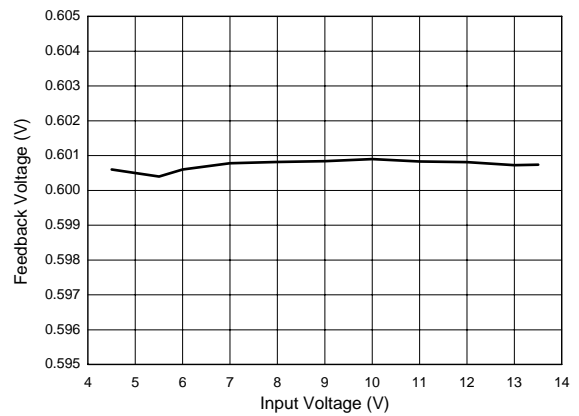
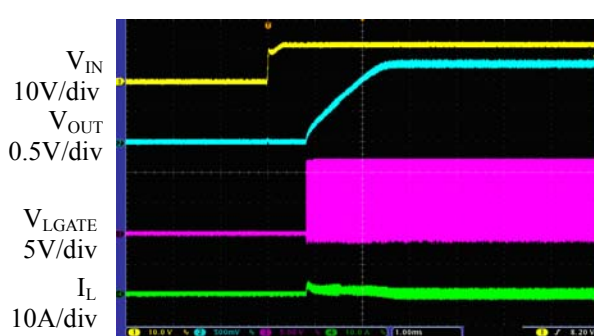
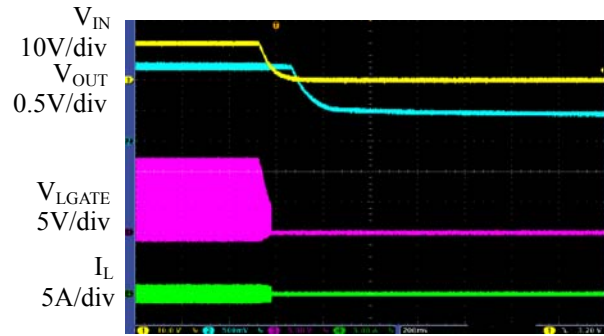

Figure 9. Feedback Voltage vs. Input Voltage

Single Phase Synchronous Buck PWM Controller With Reference Input AP3583/A
Typical Performance Characteristics (Continued)

Time 1ms/div

 Figure 10. Power-on Waveform
 ($V_{IN}=12V$, $V_{OUT}=1.2V$, $I_{OUT}=0A$)

Time 200ms/div

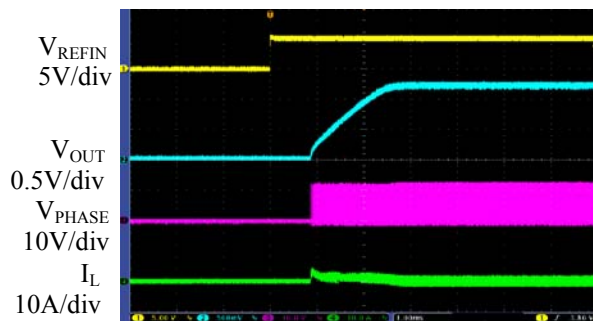
 Figure 11. Power-off Waveform
 ($V_{IN}=12V$, $V_{OUT}=1.2V$, $I_{OUT}=0A$)

Time 1ms/div

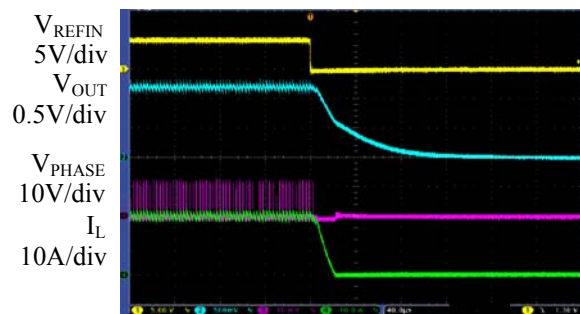
 Figure 12. Enable Waveform
 ($V_{IN}=12V$, $V_{OUT}=1.2V$, $I_{OUT}=0A$)

Time 40µs/div

 Figure 13. Disable Waveform
 ($V_{IN}=12V$, $V_{OUT}=1.2V$, $I_{OUT}=20A$)

Typical Performance Characteristics (Continued)

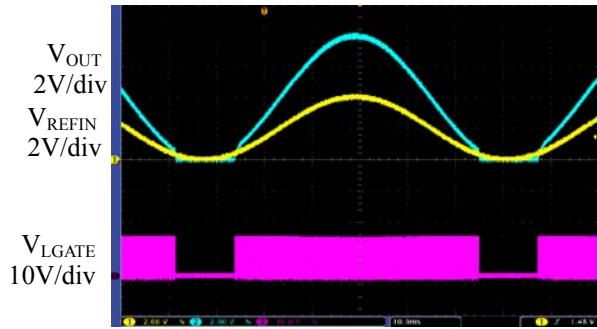

Time 10ms/div

Figure 14. REFIN Operation
($V_{IN}=12V$, $V_{OUT}=1.2V$, $I_{OUT}=5A$)

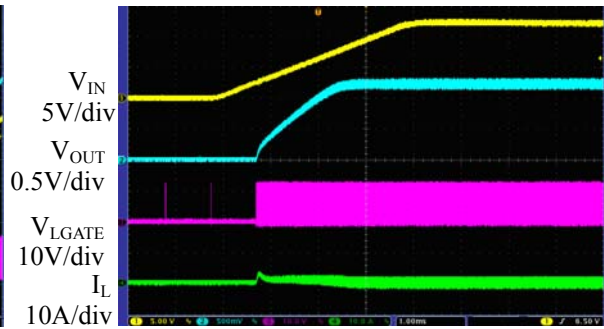

Time 1ms/div

Figure 15. Power Input Detection
($V_{IN}=12V$, $V_{OUT}=1.2V$, $I_{OUT}=0A$)

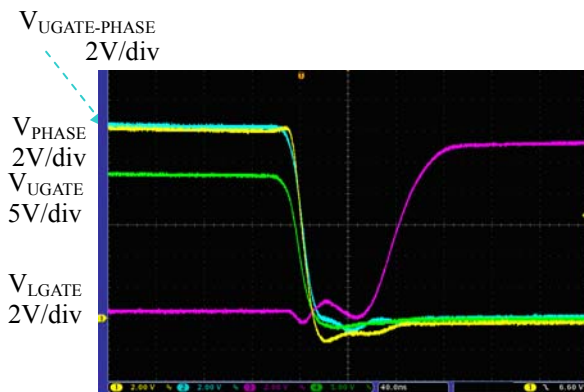

Time 40ns/div

Figure 16. UGATE Turn-off Waveforms
($V_{IN}=12V$, $V_{OUT}=1.2V$, $I_{OUT}=20A$)

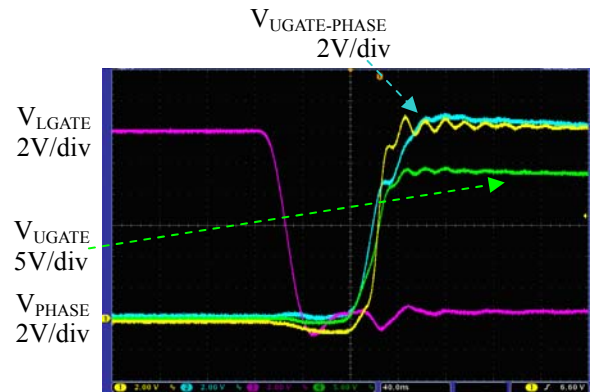

Time 40ns/div

Figure 17. UGATE Turn-on Waveforms
($V_{IN}=12V$, $V_{OUT}=1.2V$, $I_{OUT}=20A$)

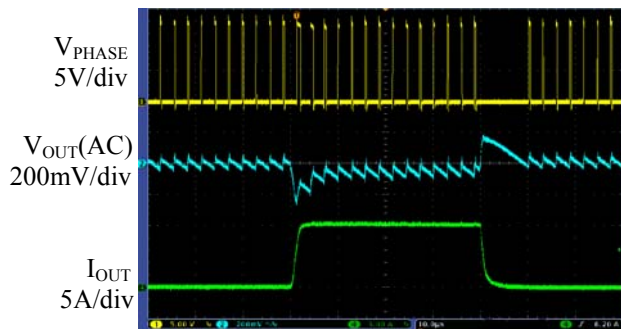
Single Phase Synchronous Buck PWM Controller With Reference Input AP3583/A
Typical Performance Characteristics (Continued)

Time 10µs/div

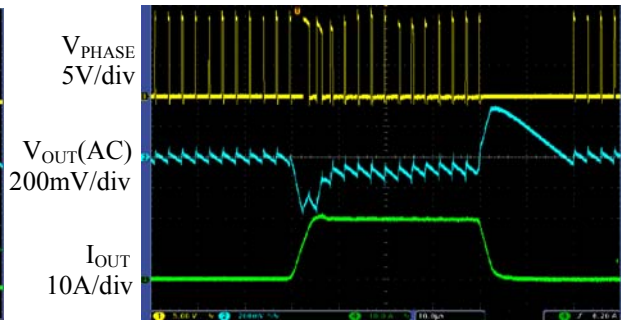
 Figure 18. Load Transient Response
 ($V_{IN}=12V$, $V_{OUT}=1.2V$, $I_{OUT}=0$ to 10A; 4A/µs)

Time 10µs/div

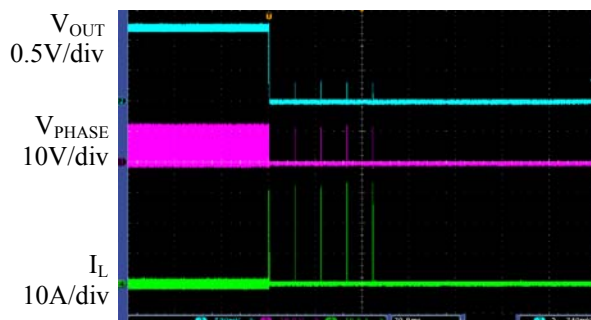
 Figure 19. Load Transient Response
 ($V_{IN}=12V$, $V_{OUT}=1.2V$, $I_{OUT}=0$ to 20A; 4A/µs)

Time 20ms/div

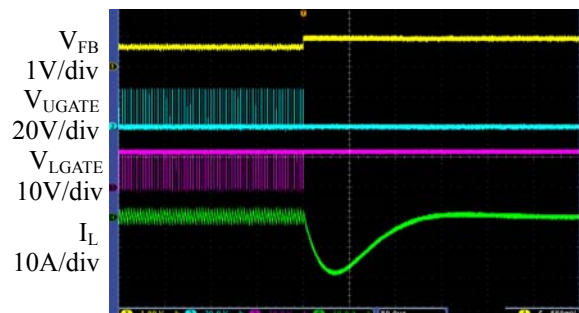
 Figure 20. Over Current Protection
 ($V_{IN}=12V$, $V_{OUT}=1.2V$ to 0V, $I_{OUT}=0A$)

Time 80µs/div

 Figure 21. Over Voltage Protection
 ($V_{IN}=12V$, $V_{OUT}=1.2V$, $I_{OUT}=0A$)

Single Phase Synchronous Buck PWM Controller With Reference Input AP3583/A

Typical Application

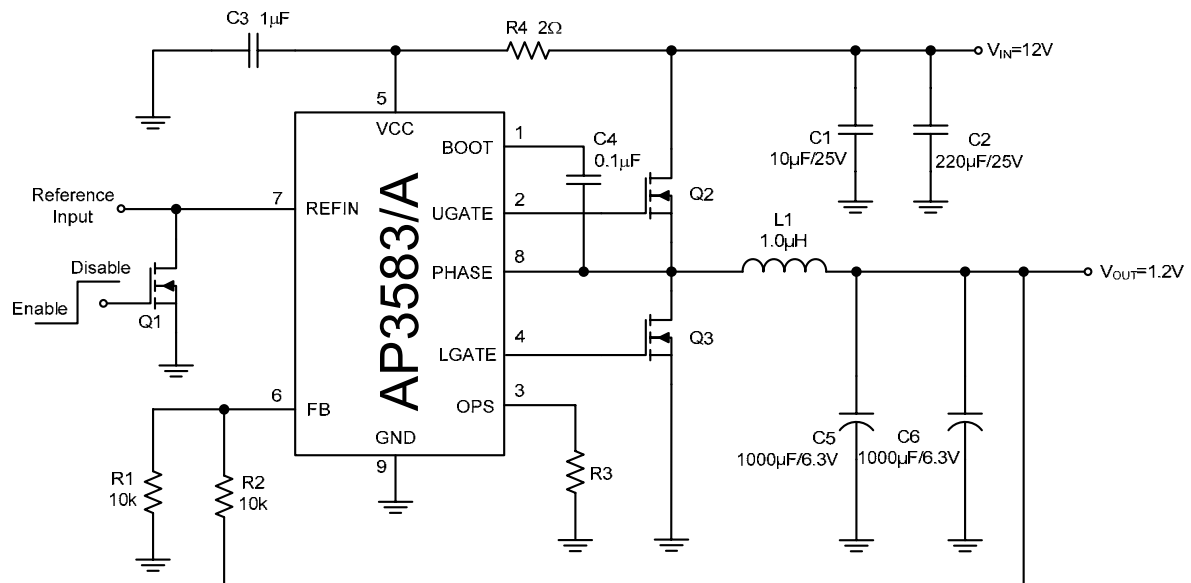
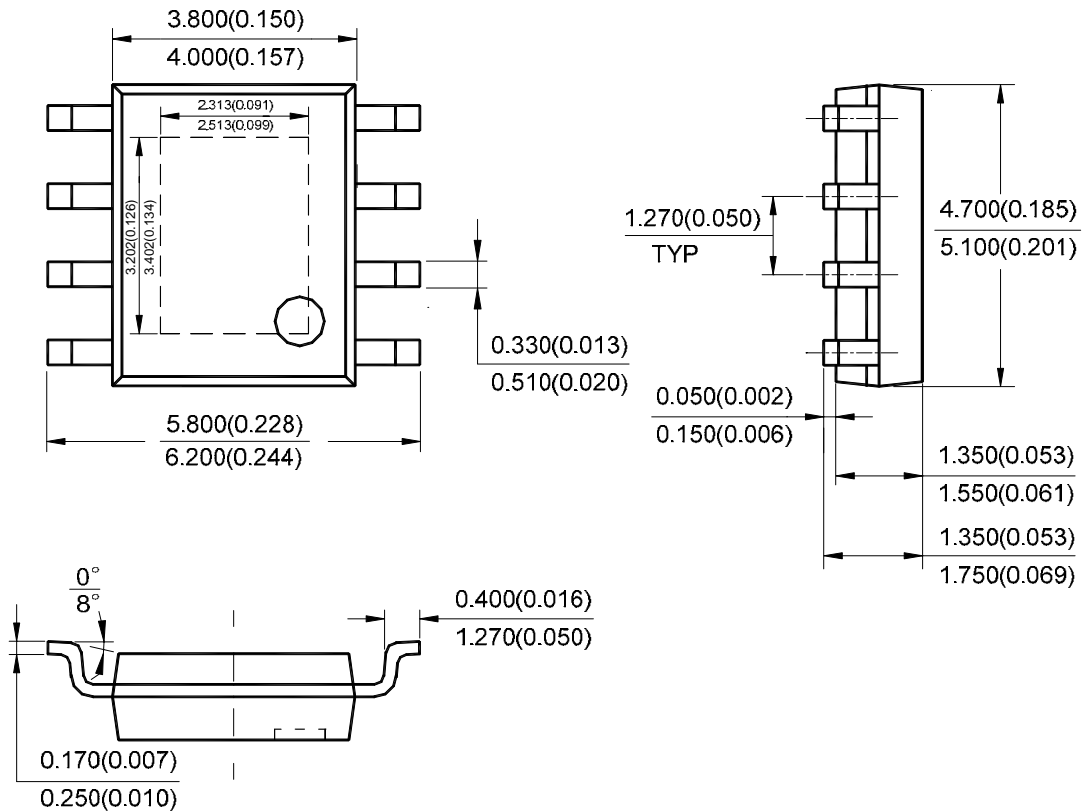

Figure 22. Typical Application Circuit of AP3583/A

Mechanical Dimensions

PSOP-8

Unit: mm(inch)



Note: Eject hole, oriented hole and mold mark is optional.



BCD Semiconductor Manufacturing Limited

<http://www.bcdsemi.com>

IMPORTANT NOTICE

BCD Semiconductor Manufacturing Limited reserves the right to make changes without further notice to any products or specifications herein. BCD Semiconductor Manufacturing Limited does not assume any responsibility for use of any its products for any particular purpose, nor does BCD Semiconductor Manufacturing Limited assume any liability arising out of the application or use of any its products or circuits. BCD Semiconductor Manufacturing Limited does not convey any license under its patent rights or other rights nor the rights of others.

MAIN SITE

- Headquarters

BCD Semiconductor Manufacturing Limited

No. 1600, Zi Xing Road, Shanghai Zizhu Science-based Industrial Park, 200241, China
Tel: +86-21-24162266, Fax: +86-21-24162277

- Wafer Fab

Shanghai SIM-BCD Semiconductor Manufacturing Co., Ltd.

800 Yi Shan Road, Shanghai 200233, China
Tel: +86-21-6485 1491, Fax: +86-21-5450 0008

REGIONAL SALES OFFICE

Shenzhen Office

Shanghai SIM-BCD Semiconductor Manufacturing Co., Ltd., Shenzhen Office

Unit A Room 1203, Skyworth Bldg., Gaoxin Ave. 1.S., Nanshan District, Shenzhen, China
Tel: +86-755-8826 7951
Fax: +86-755-8826 7865

Taiwan Office

BCD Semiconductor (Taiwan) Company Limited

4F, 298-1, Rui Guang Road, Nei-Hu District, Taipei, Taiwan
Tel: +886-2-2656 2808
Fax: +886-2-2656 2806

USA Office

BCD Semiconductor Corp.

30920 Huntwood Ave. Hayward, CA 94544, USA
Tel : +1-510-324-2988
Fax: +1-510-324-2788