

AP4501SD

*N AND P-CHANNEL ENHANCEMENT
MODE POWER MOSFET*

▼ Simple Drive Requirement

▼ Low On-resistance

▼ Fast Switching

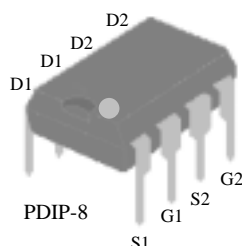

N-CH	BV_{DSS}	30V
	$R_{DS(ON)}$	27m Ω
	I_D	7A
P-CH	BV_{DSS}	-30V
	$R_{DS(ON)}$	49m Ω
	I_D	-5A

Description

The Advanced Power MOSFETs from APEC provide the designer with the best combination of fast switching, ruggedized device design, low on-resistance and cost-effectiveness.

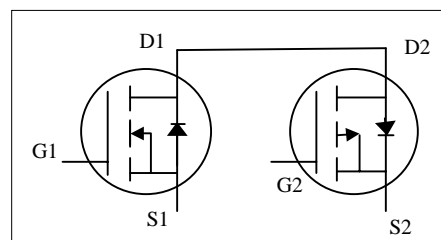

Absolute Maximum Ratings

Symbol	Parameter	Rating		Units
		N-channel	P-channel	
V_{DS}	Drain-Source Voltage	30	-30	V
V_{GS}	Gate-Source Voltage	± 20	± 20	V
$I_D @ T_A = 25^\circ\text{C}$	Continuous Drain Current ³	7	-5	A
$I_D @ T_A = 70^\circ\text{C}$	Continuous Drain Current ³	5.8	-4.2	A
I_{DM}	Pulsed Drain Current ¹	40	-30	A
$P_D @ T_A = 25^\circ\text{C}$	Total Power Dissipation	2		W
	Linear Derating Factor	0.016		W/ $^\circ\text{C}$
T_{STG}	Storage Temperature Range	-55 to 150		$^\circ\text{C}$
T_J	Operating Junction Temperature Range	-55 to 150		$^\circ\text{C}$

Thermal Data

Symbol	Parameter	Value	Unit
$R_{thj-amb}$	Thermal Resistance Junction-ambient ³	Max.	$^\circ\text{C}/\text{W}$



AP4501SD

N-CH Electrical Characteristics @ $T_j=25^\circ\text{C}$ (unless otherwise specified)

Symbol	Parameter	Test Conditions	Min.	Typ.	Max.	Units
BV_{DSS}	Drain-Source Breakdown Voltage	$V_{GS}=0V, I_D=250\mu A$	30	-	-	V
$\Delta BV_{DSS}/\Delta T_j$	Breakdown Voltage Temperature Coefficient	Reference to 25°C , $I_D=1\text{mA}$	-	0.03	-	$V/^\circ\text{C}$
$R_{DS(ON)}$	Static Drain-Source On-Resistance ²	$V_{GS}=10V, I_D=7A$	-	-	27	$\text{m}\Omega$
		$V_{GS}=4.5V, I_D=5A$	-	-	50	$\text{m}\Omega$
$V_{GS(th)}$	Gate Threshold Voltage	$V_{DS}=V_{GS}, I_D=250\mu A$	1	-	3	V
g_{fs}	Forward Transconductance	$V_{DS}=10V, I_D=7A$	-	12	-	S
I_{DSS}	Drain-Source Leakage Current ($T_j=25^\circ\text{C}$)	$V_{DS}=30V, V_{GS}=0V$	-	-	1	μA
	Drain-Source Leakage Current ($T_j=150^\circ\text{C}$)	$V_{DS}=24V, V_{GS}=0V$	-	-	25	μA
I_{GSS}	Gate-Source Leakage	$V_{GS}=\pm 20V$	-	-	± 100	nA
Q_g	Total Gate Charge ²	$I_D=7A$	-	8.4	-	nC
Q_{gs}	Gate-Source Charge	$V_{DS}=24V$	-	2.1	-	nC
Q_{gd}	Gate-Drain ("Miller") Charge	$V_{GS}=4.5V$	-	4.7	-	nC
$t_{d(on)}$	Turn-on Delay Time ²	$V_{DS}=15V$	-	6	-	ns
t_r	Rise Time	$I_D=1A$	-	5.2	-	ns
$t_{d(off)}$	Turn-off Delay Time	$R_G=3.3\Omega, V_{GS}=10V$	-	18.8	-	ns
t_f	Fall Time	$R_D=15\Omega$	-	4.4	-	ns
C_{iss}	Input Capacitance	$V_{GS}=0V$	-	645	-	pF
C_{oss}	Output Capacitance	$V_{DS}=25V$	-	150	-	pF
C_{rss}	Reverse Transfer Capacitance	$f=1.0\text{MHz}$	-	95	-	pF

Source-Drain Diode

Symbol	Parameter	Test Conditions	Min.	Typ.	Max.	Units
I_S	Continuous Source Current (Body Diode)	$V_D=V_G=0V, V_S=1.2V$	-	-	1.7	A
V_{SD}	Forward On Voltage ²	$T_j=25^\circ\text{C}, I_S=1.7A, V_{GS}=0V$	-	-	1.2	V



AP4501SD

P-CH Electrical Characteristics @ $T_j=25^{\circ}\text{C}$ (unless otherwise specified)

Symbol	Parameter	Test Conditions	Min.	Typ.	Max.	Units
BV_{DSS}	Drain-Source Breakdown Voltage	$V_{GS}=0V, I_D=-250\mu A$	-30	-	-	V
$\Delta BV_{DSS}/\Delta T_j$	Breakdown Voltage Temperature Coefficient	Reference to 25°C , $I_D=-1\text{mA}$	-	-0.03	-	$V/^{\circ}\text{C}$
$R_{DS(ON)}$	Static Drain-Source On-Resistance ²	$V_{GS}=-10V, I_D=-5A$	-	-	49	$\text{m}\Omega$
		$V_{GS}=-4.5V, I_D=-3A$	-	-	75	$\text{m}\Omega$
$V_{GS(th)}$	Gate Threshold Voltage	$V_{DS}=V_{GS}, I_D=-250\mu A$	-1	-	-3	V
g_{fs}	Forward Transconductance	$V_{DS}=-10V, I_D=-5.3A$	-	8	-	S
I_{DSS}	Drain-Source Leakage Current ($T_j=25^{\circ}\text{C}$)	$V_{DS}=-30V, V_{GS}=0V$	-	-	-1	μA
	Drain-Source Leakage Current ($T_j=150^{\circ}\text{C}$)	$V_{DS}=-24V, V_{GS}=0V$	-	-	-25	μA
I_{GSS}	Gate-Source Leakage	$V_{GS}=\pm 20V$	-	-	± 100	nA
Q_g	Total Gate Charge ²	$I_D=-5.3A$	-	9	-	nC
Q_{gs}	Gate-Source Charge	$V_{DS}=-15V$	-	3.5	-	nC
Q_{gd}	Gate-Drain ("Miller") Charge	$V_{GS}=-4.5V$	-	2	-	nC
$t_{d(on)}$	Turn-on Delay Time ²	$V_{DS}=-15V$	-	12	-	ns
t_r	Rise Time	$I_D=-1A$	-	20	-	ns
$t_{d(off)}$	Turn-off Delay Time	$R_G=6\Omega, V_{GS}=-10V$	-	45	-	ns
t_f	Fall Time	$R_D=15\Omega$	-	27	-	ns
C_{iss}	Input Capacitance	$V_{GS}=0V$	-	760	-	pF
C_{oss}	Output Capacitance	$V_{DS}=-25V$	-	330	-	pF
C_{rss}	Reverse Transfer Capacitance	$f=1.0\text{MHz}$	-	90	-	pF

Source-Drain Diode

Symbol	Parameter	Test Conditions	Min.	Typ.	Max.	Units
I_S	Continuous Source Current (Body Diode)	$V_D=V_G=0V, V_S=-1.2V$	-	-	-1.7	A
V_{SD}	Forward On Voltage ²	$T_j=25^{\circ}\text{C}, I_S=-1.7A, V_{GS}=0V$	-	-	-1.2	V

Notes:

1. Pulse width limited by Max. junction temperature.
2. Pulse width $\leq 300\mu s$, duty cycle $\leq 2\%$.
3. Mounted on 1 in^2 copper pad of FR4 board ; $90^{\circ}\text{C}/\text{W}$ when mounted on Min. copper pad.



AP4501SD

N-Channel

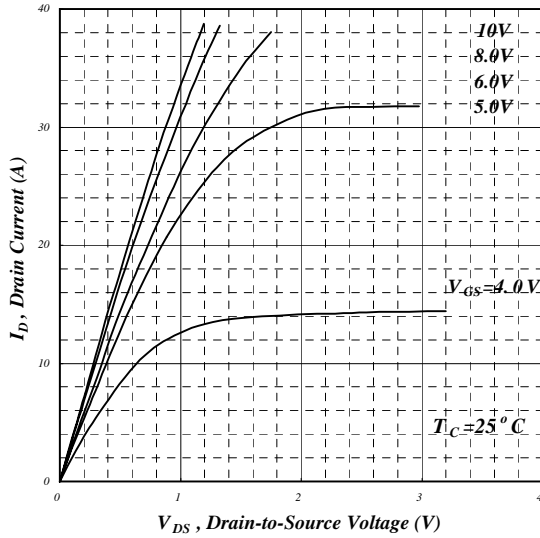

Fig 1. Typical Output Characteristics

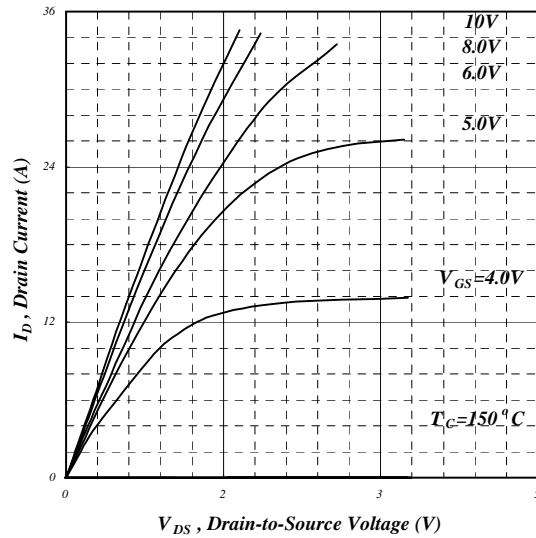

Fig 2. Typical Output Characteristics

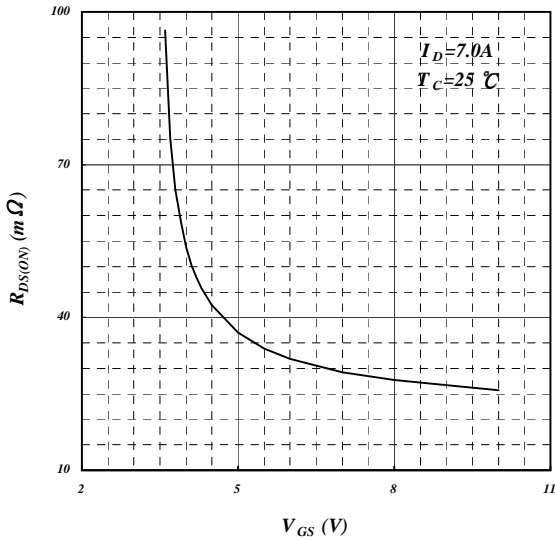

Fig 3. On-Resistance v.s. Gate Voltage

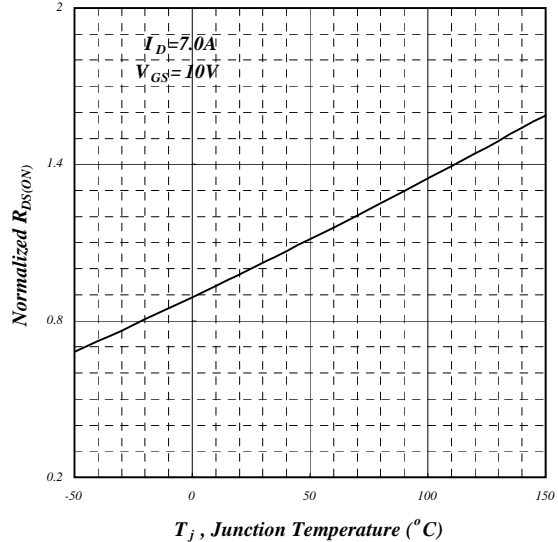

Fig 4. Normalized On-Resistance v.s. Junction Temperature



AP4501SD

N-Channel

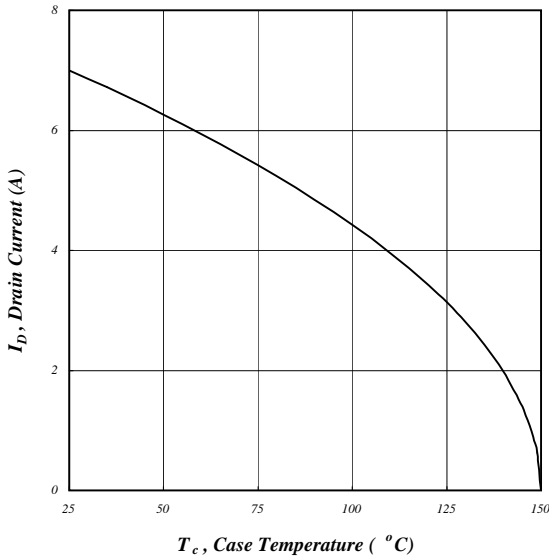

Fig 5. Maximum Drain Current v.s. Case Temperature

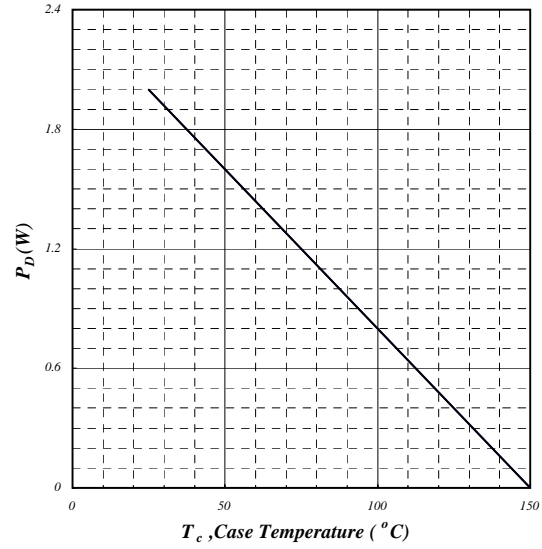

Fig 6. Typical Power Dissipation

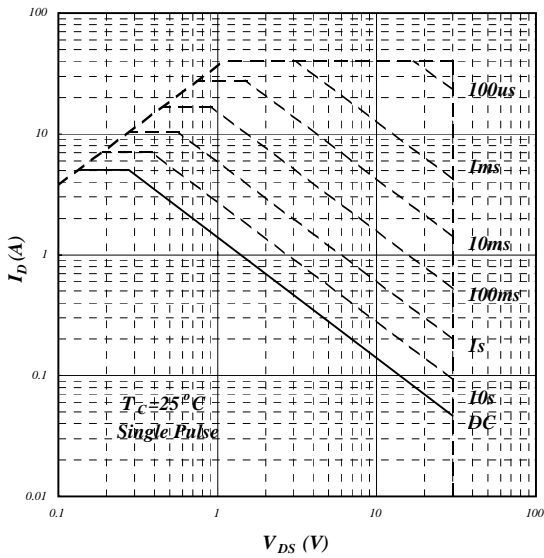

Fig 7. Maximum Safe Operating Area

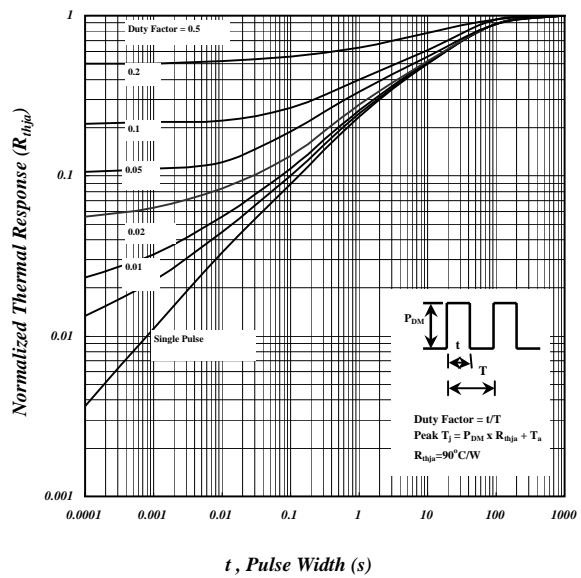

Fig 8. Effective Transient Thermal Impedance



AP4501SD

N-Channel

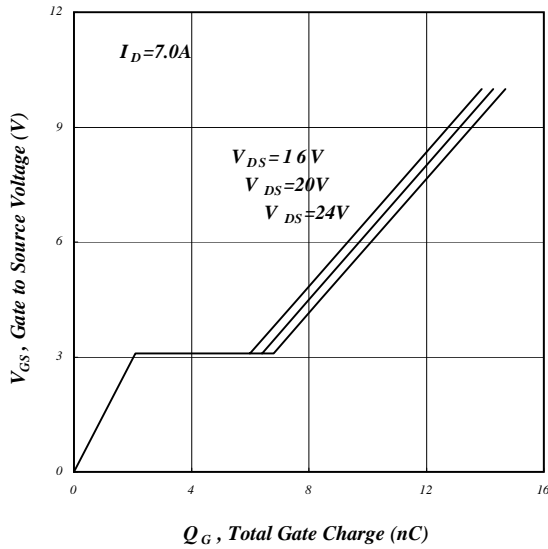

Fig 9. Gate Charge Characteristics

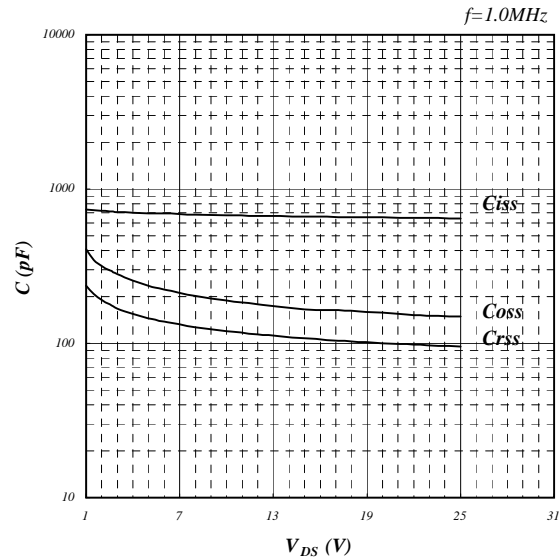

Fig 10. Typical Capacitance Characteristics

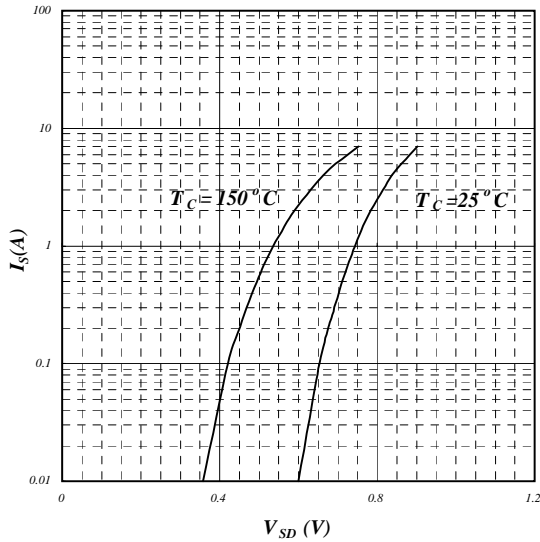

Fig 11. Forward Characteristic of Reverse Diode

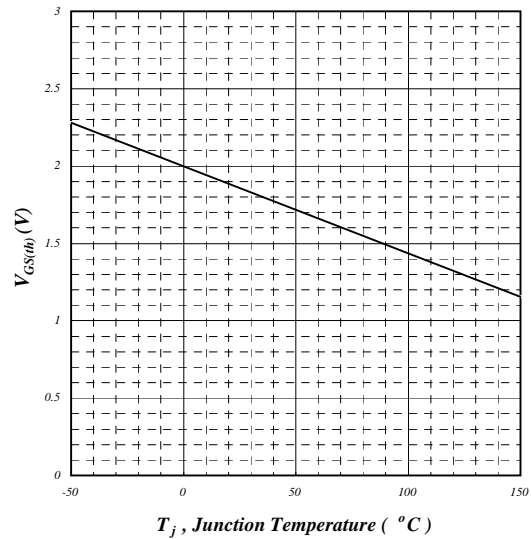

Fig 12. Gate Threshold Voltage v.s. Junction Temperature



AP4501SD

N-Channel

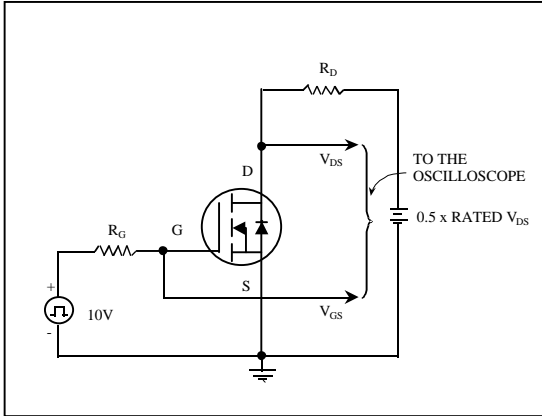

Fig 13. Switching Time Circuit

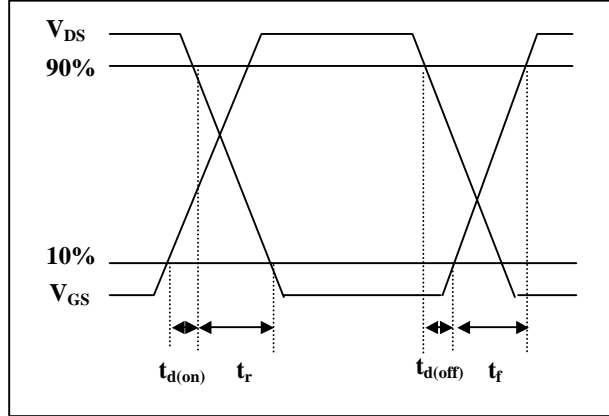

Fig 14. Switching Time Waveform

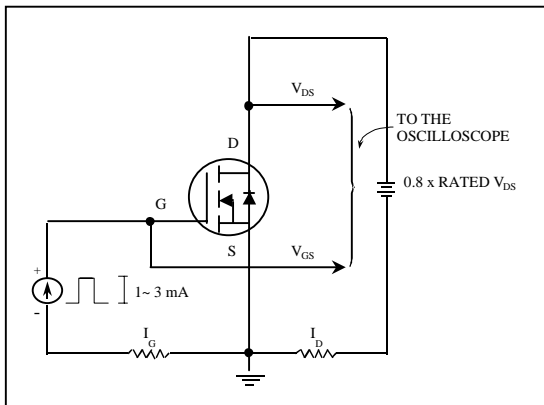

Fig 15. Gate Charge Circuit

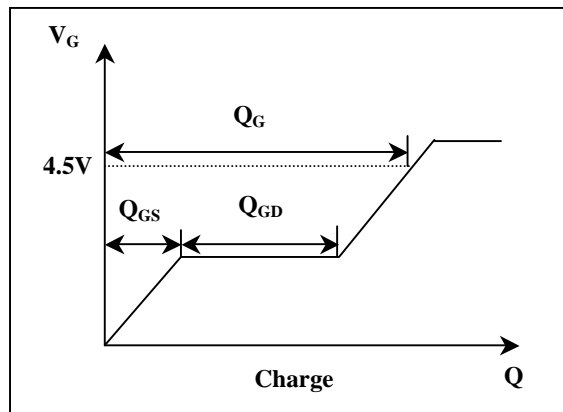

Fig 16. Gate Charge Waveform



AP4501SD

P-Channel

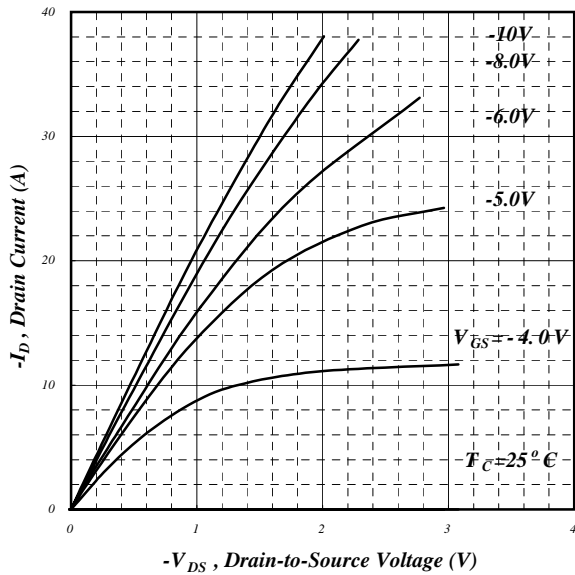

Fig 1. Typical Output Characteristics

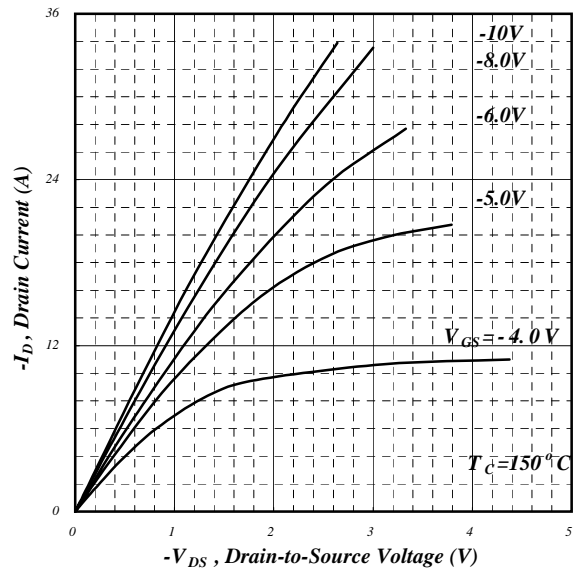

Fig 2. Typical Output Characteristics

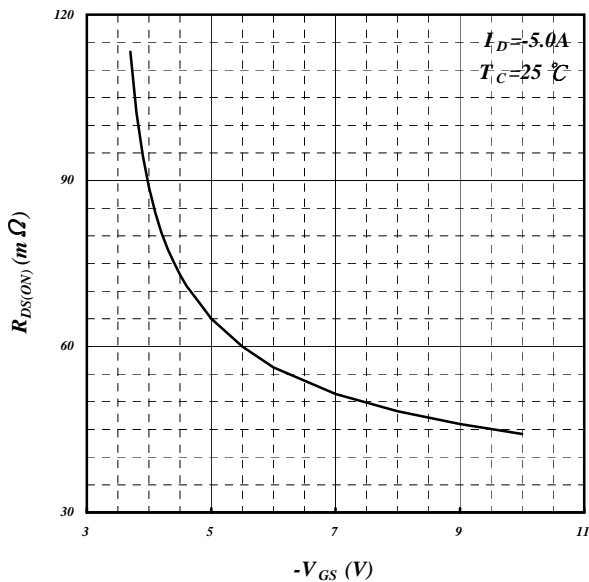

Fig 3. On-Resistance v.s. Gate Voltage

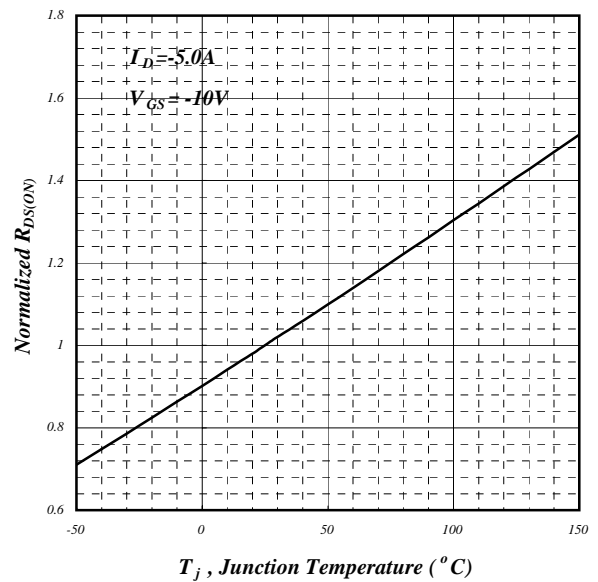

Fig 4. Normalized On-Resistance v.s. Junction Temperature



P-Channel

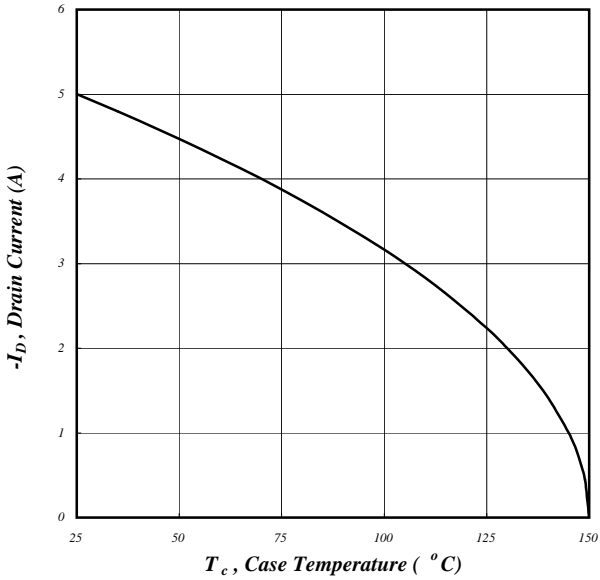

Fig 5. Maximum Drain Current v.s. Case Temperature

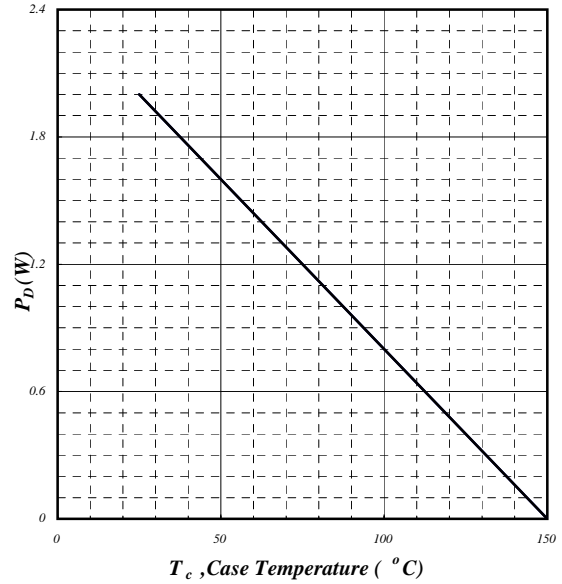

Fig 6. Typical Power Dissipation

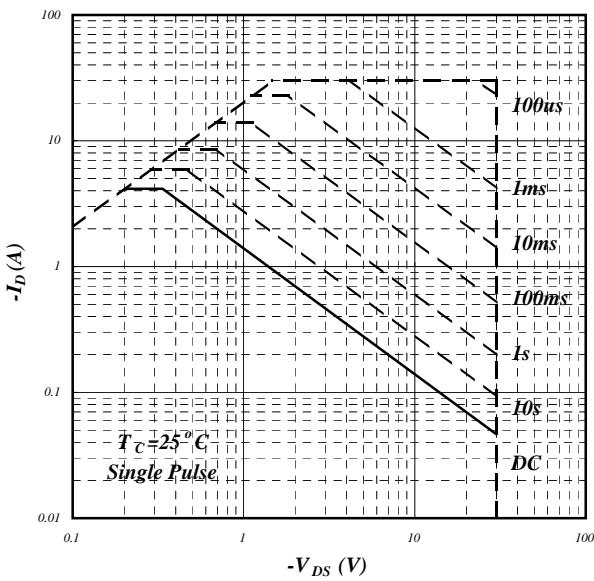

Fig 7. Maximum Safe Operating Area

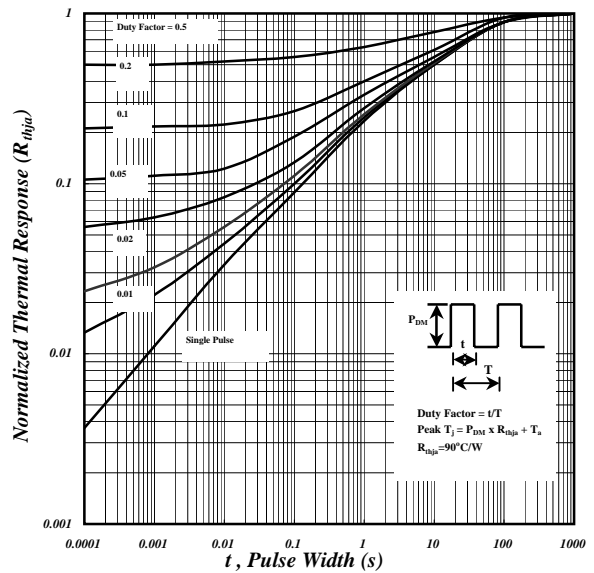

Fig 8. Effective Transient Thermal Impedance



AP4501SD

P-Channel

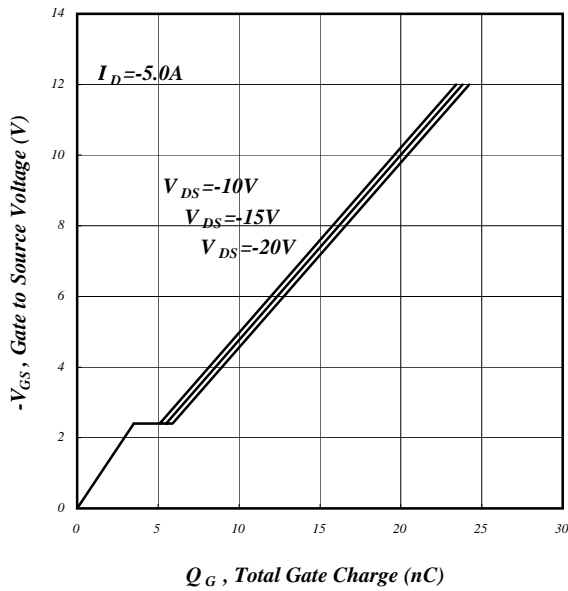

Fig 9. Gate Charge Characteristics

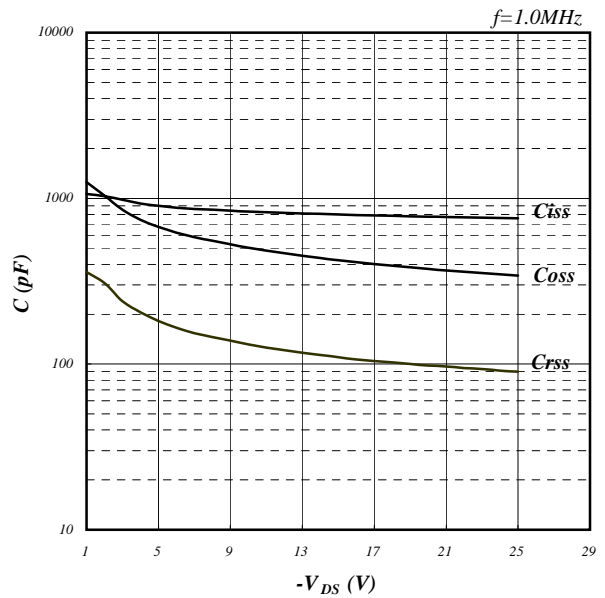

Fig 10. Typical Capacitance Characteristics

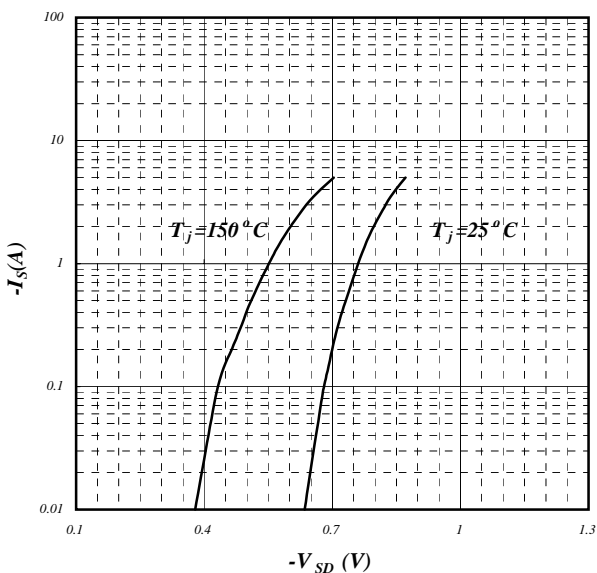

Fig 11. Forward Characteristic of Reverse Diode

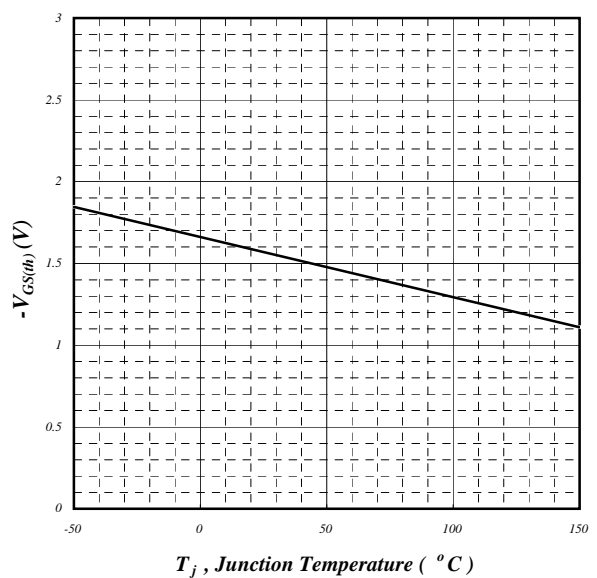

Fig 12. Gate Threshold Voltage v.s. Junction Temperature



P-Channel

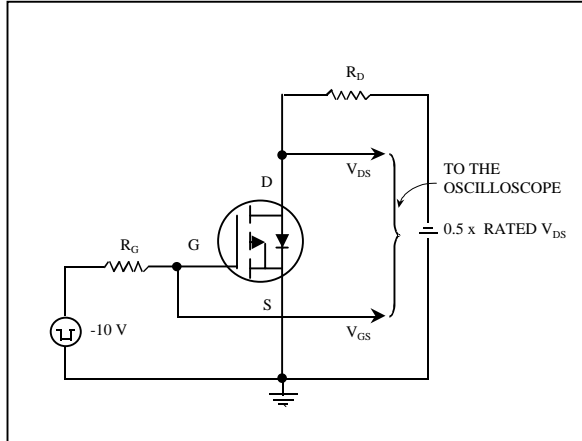

Fig 13. Switching Time Circuit

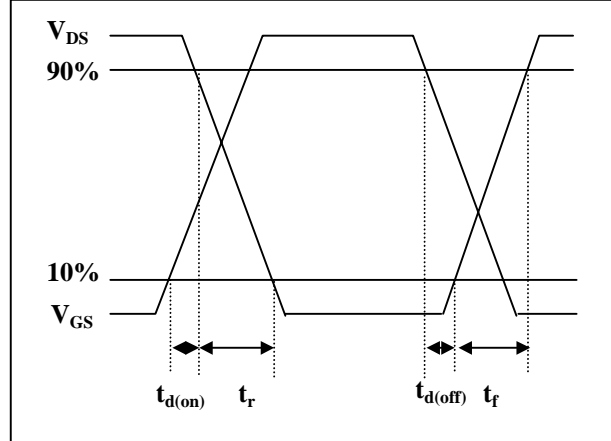

Fig 14. Switching Time Waveform

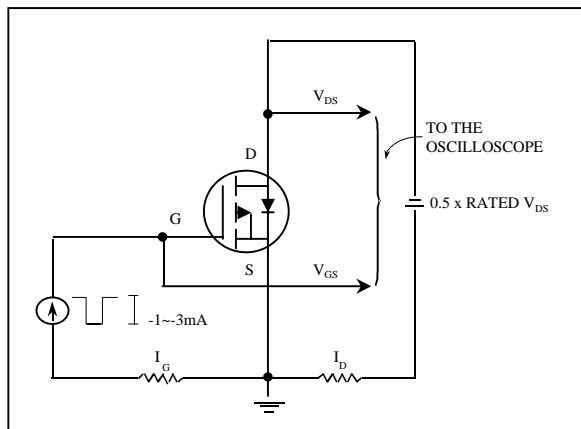

Fig 15. Gate Charge Circuit

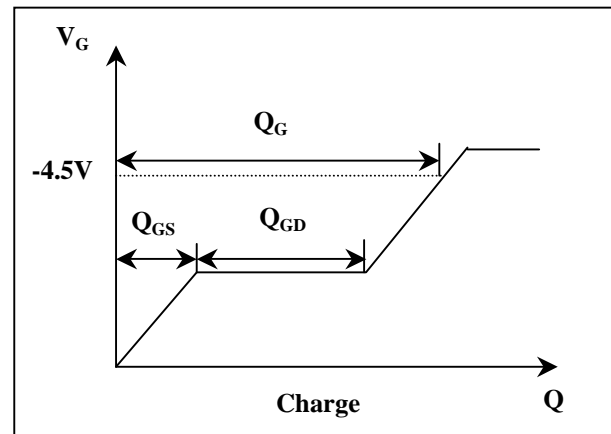

Fig 16. Gate Charge Waveform