

wj AP512

UMTS-band 8W HBT Amplifier Module

The Communications Edge™

Product Information

Product Features

- 2110 – 2170 MHz
- 28.5 dB Gain
- -55 dBc ACLR
@ 28 dBm W-CDMA linear power
- +39 dBm P1dB
- +12 V Single Supply
- Power Down Mode
- Bias Current Adjustable
- RoHS-complaint flange-mount pkg

Applications

- Final stage amplifiers for Repeaters
- Optimized for driver amplifier PA mobile infrastructure

Product Description

The AP512 is a high dynamic range power amplifier in a RoHS-compliant flange-mount package. The multi-stage amplifier module has 28.5 dB gain, while being able to achieve high performance for UMTS-band applications with +39 dBm of compressed 1dB power. The module has been internally optimized for linearity to provide -55 dBc ALCR at 28 dBm power for W-CDMA applications.

The AP512 uses a high reliability InGaP/GaAs HBT process technology and does not require any external matching components. The module operates off of a +12V supply and does not require any negative biasing voltages; an internal active bias allows the amplifier to maintain high linearity over temperature. It has the added feature of a +5V power down control pin. A low-cost metal housing allows the device to have a low thermal resistance and achieves over 100 years MTTF. All devices are 100% RF and DC tested.

The AP512 is targeted for use as a driver or final stage amplifier in wireless infrastructure where high linearity and high power is required. This combination makes the device an excellent candidate for next generation multi-carrier 3G base stations or repeaters using the UMTS frequency band.

Functional Diagram

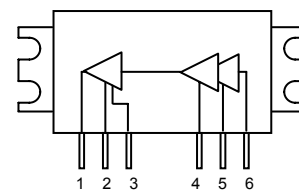

Top View

Pin No.	Function
1	RF Output
2 / 4	Vcc
3 / 5	Vpd
6	RF Input
Case	Ground

Specifications ⁽¹⁾

Parameter	Units	Min	Typ	Max	Test Conditions
Operational Bandwidth	MHz	2110 – 2170			
Test Frequency	MHz	2140			
Adjacent Channel Leakage Ratio	dBc		-55	-50	W-CDMA +28 dBm Total Power, ±5 MHz offset
Power Gain	dB	26	28.5	31	Pout = +28 dBm
Input Return Loss	dB		14		
Output Return Loss	dB		6		
Output P1dB	dBm		+39		
Output IP3	dBm		+53		Pout = +28 dBm/tone, Δf = 1 MHz
Operating Current ⁽²⁾	A		1.72		Pout = +28 dBm
Quiescent Current, Icq ⁽²⁾	A	1.55	1.69	1.80	
Device Voltage, Vcc	V		+12		
Device Voltage, Vpd ⁽³⁾	V		+5		Pull-down voltage: 0V = "OFF", 5V="ON"
Ruggedness	VSWR	10:1			Pout = +39 dBm CW, all phases

1. Test conditions unless otherwise noted: 25°C.

2. The current can be adjusted through an external resistor from the 5V supply to the pull-down voltage pin (pin 3).

Absolute Maximum Rating

Parameter	Rating
Operating Case Temperature	-40 to +85 °C
Storage Temperature	-55 to +150 °C
RF Input Power (continuous) WCDMA signal (3GPP Test Model 1+ 32 DPCH)	+10 dBm

Operation of this device above any of these parameters may cause permanent damage.

Ordering Information

Part No.	Description
AP512	UMTS-band 8W HBT Amplifier Module
AP512-PCB	Fully-Assembled Evaluation Board

Specifications and information are subject to change without notice



Class AB Configuration (AP512-PCB)

The AP512-PCB and AP512 module is configured for Class AB by default. The resistor – R7 – which sets the current draw for the amplifier is set at 0 Ω in this configuration. Increasing that value will decrease the quiescent and operating current of the amplifier module, as described on the next page.

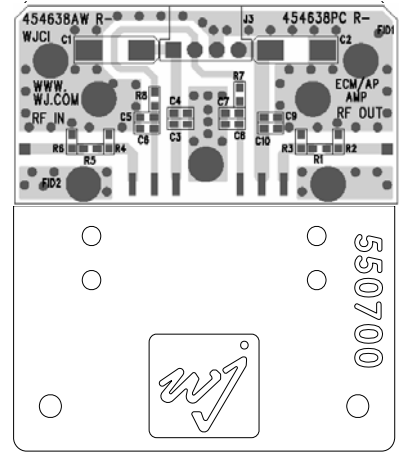
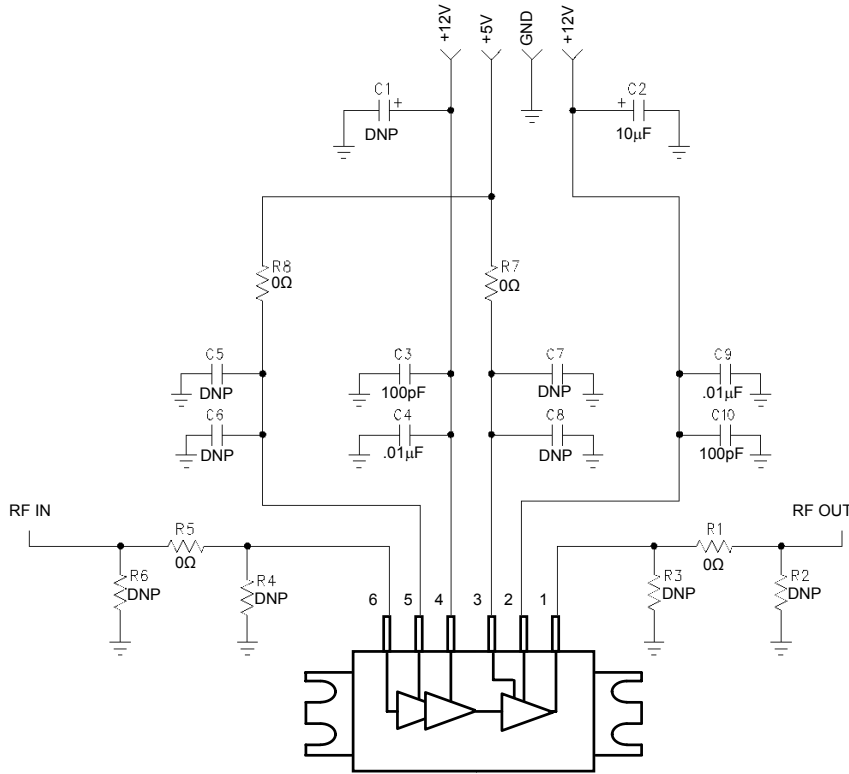

Notes:

1. **Please note that for reliable operation, the evaluation board and mounting plate will have to be attached to a much larger heat sink during operation and in laboratory environments to dissipate the power consumed by the device.** The use of a convection fan is also recommended in laboratory environments. Details of the mounting holes used in the WJ mounting plate are given on the last page of this datasheet.
2. The area around the module underneath the PCB should not contain any soldermask in order to maintain good RF grounding.
3. For proper and safe operation in the laboratory, the power-on sequencing should be followed:
 1. Connect RF In and Out
 2. Connect the voltages and ground pins as shown in the circuit.
 3. Apply the RF signal
 4. Power down with the reverse sequence



Performance Graphs (AP512-PCB)

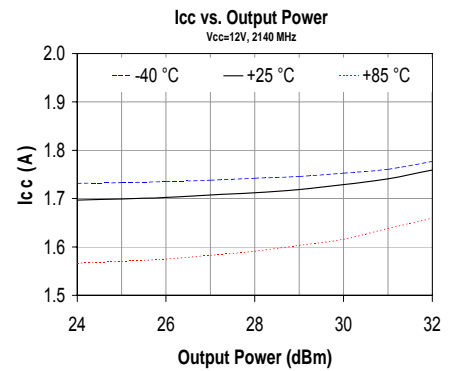
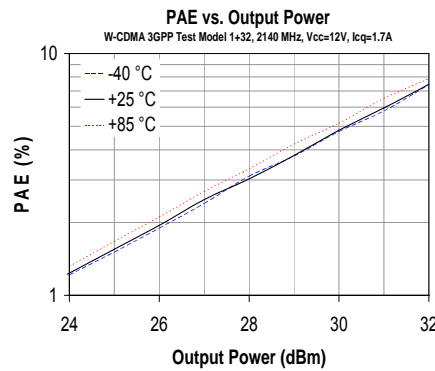
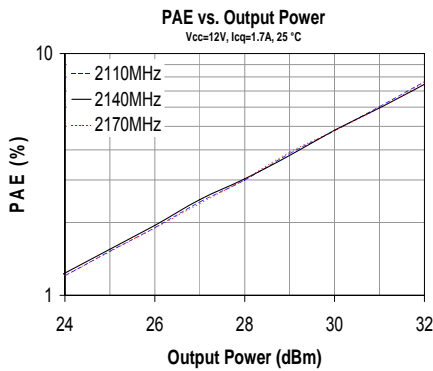
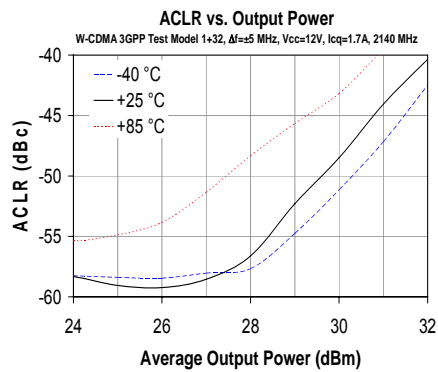
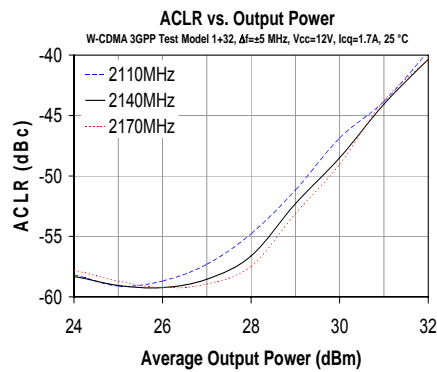
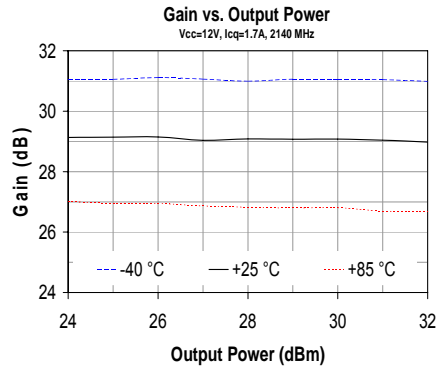
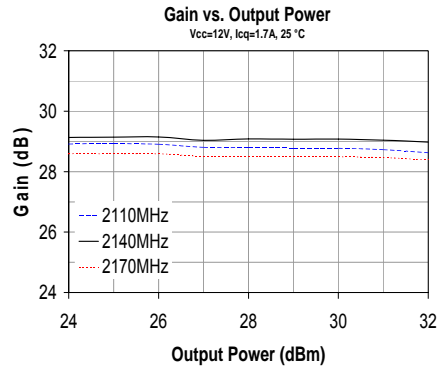



MTTF Calculation

The MTTF of the AP512 can be calculated by first determining how much power is being dissipated by the amplifier module. Because the device's intended application is to be a power amplifier pre-driver or final stage output amplifier, the output RF power of the amplifier will help lower the overall power dissipation. In addition, the amplifier can be biased with different quiescent currents, so the calculation of the MTTF is custom to each application.

The power dissipation of the device can be calculated with the following equation:

$$P_{diss} = V_{cc} * I_{cc} - (\text{Output RF Power} - \text{Input RF Power}),$$

V_{cc} = Operating supply voltage = **12V**
 I_{cc} = Operating current
 {The RF power is converted to Watts}

While the maximum recommended case temperature on the datasheet is listed at 85 °C, it is suggested that customers maintain an MTTF above 1 million hours. This would convert to a derating curve for maximum case temperature vs. power dissipation as shown in the plot below.

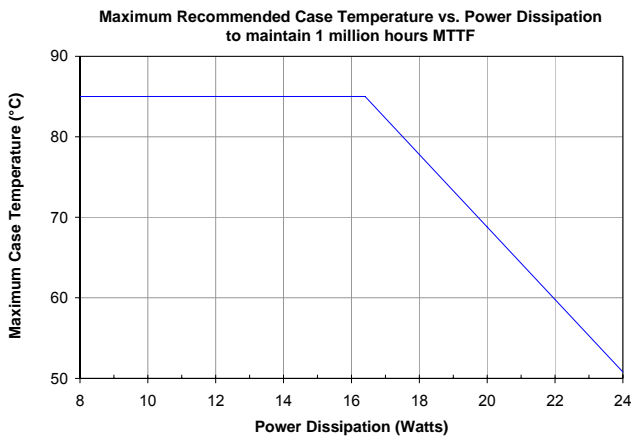

To calculate the MTTF for the module, the junction temperature needs to be determined. This can be easily calculated with the module's power dissipation, the thermal resistance value, and the case temperature of operation:

$$T_j = P_{diss} * R_{th} + T_{case}$$

T_j = Junction temperature
 P_{diss} = Power dissipation (calculated from above)
 R_{th} = Thermal resistance = **4.5 °C/W**
 T_{case} = Case temperature of module's heat sink

From a numerical standpoint, the MTTF can be calculated using the Arrhenius equation:

$$MTTF = A * e^{(E_a/k/T_j)}$$

A = Pre-exponential Factor = **6.087 x 10⁻¹¹ hours**
 E_a = Activation Energy = **1.39 eV**
 k = Boltzmann's Constant = **8.617 x 10⁻⁵ eV/°K**
 T_j = Junction Temperature (°K) = T_j (°C) + 273

A graphical view of the MTTF can be shown in the plot below.

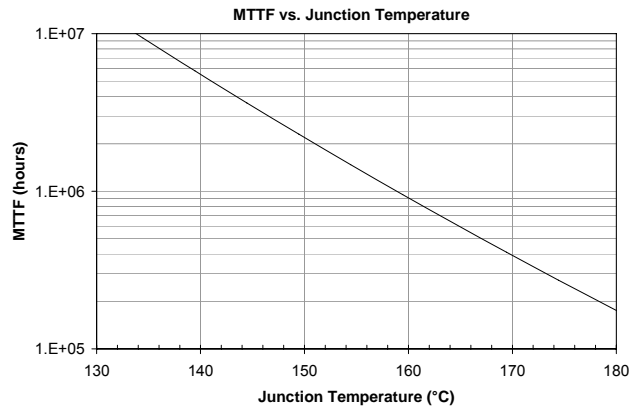



AP512

UMTS-band 8W HBT Amplifier Module

The Communications Edge™

Product Information

Outline Drawing

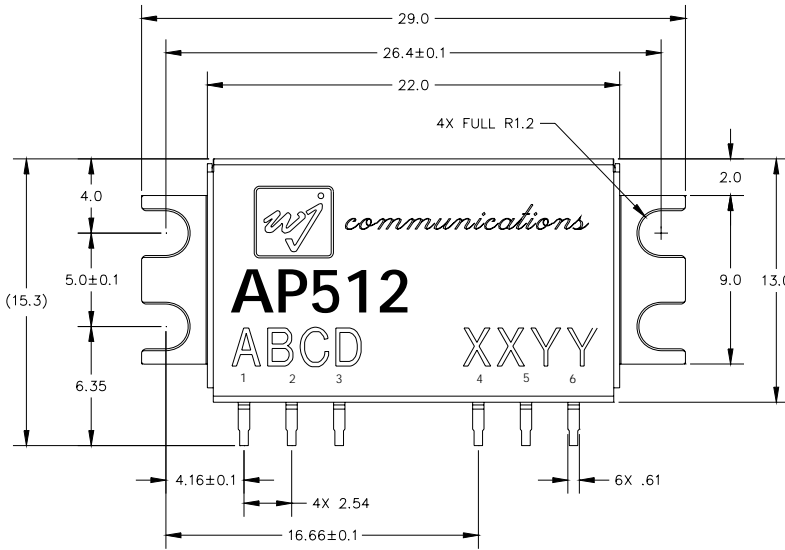

NOTES:

- DIMENSIONING & TOLERANCING CONFORM TO ANSI Y14.4M-1994.
- ALL DIMENSIONS ARE IN MILLIMETERS (INCHES). ANGLES ARE IN DEGREES.
- PIN ASSIGNMENTS:
 [PIN 1] RF OUT
 [PIN 2] +12 Vcc
 [PIN 3] Vpd
 [PIN 4] +12 Vcc
 [PIN 5] Vpd
 [PIN 6] RF IN
 [CASE] GROUND

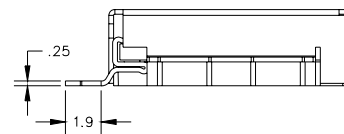
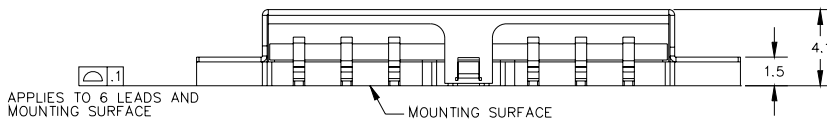

Outline Drawing for the Heatsink Shipped with the WJ Evaluation Board

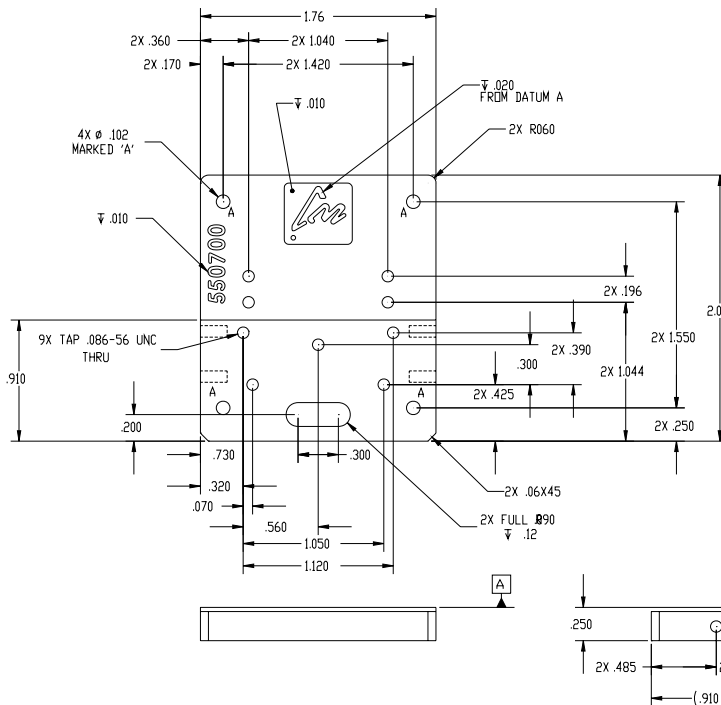

Product Marking

The device will be marked with an "AP512" designator with an alphanumeric lot code on the top surface of the package noted as "ABCD" on the drawing. A manufacturing date will also be printed as "XXYY", where the "XX" represents the week number from 1 – 52.

The product will be shipped in tubes in multiples of 15.

ESD / MSL Information



Caution! ESD sensitive device.

ESD Rating: Class 1C
 Value: Passes at ≥ 1,000 to < 2,000 volts
 Test: Human Body Model (HBM)
 Standard: JEDEC Standard JESD22-A114

ESD Rating: Class III
 Value: Passes ≥ 500 to < 1,000 volts
 Test: Charged Device Model (CDM)
 Standard: JEDEC Standard JESD22-C101

The supplied mounting plate with the evaluation board should be mounted and attached to a larger heatsink for proper thermal operation in a laboratory environment.

Specifications and information are subject to change without notice