



AP622

UMTS-band 4W HBT Amplifier Module

Product Features

- 2.11 – 2.17 GHz
- 28 dB Gain
- -55 dBc ACLR @ +23 dBm Pavg
- +35 dBm P1dB
- +28 V Supply
- Power Down Mode
- RoHS-compliant flange-mount pkg

Applications

- WCDMA Power Amplifiers
- Repeaters

Product Description

The AP622 power amplifier module is a two-stage power amplifier module that operates over the frequency range of 2110 – 2170 MHz and is housed in a small, RoHS-compliant, flange-mount package. The multi-stage amplifier module has a 28 dB gain, P1dB of 35dBm, and ACLR of -55dBc at +23 dBm output power for WCDMA applications.

The AP622 uses a +28V high reliability InGaP/GaAs HBT process technology and does not require any external matching components. The amplifier module operates off a +28V supply; an internal active bias allows the amplifier to maintain high linearity over temperature. It has the added feature of a +5V power down control pin. A low-cost metal housing allows the device to have a low thermal resistance to ensure long lifetimes. All devices are 100% RF and DC tested.

The AP622 is targeted for use as a driver stage amplifier in wireless infrastructure where high linearity and high power is required. This combination makes the device an excellent candidate for next generation multi-carrier 3G base stations.

Functional Diagram

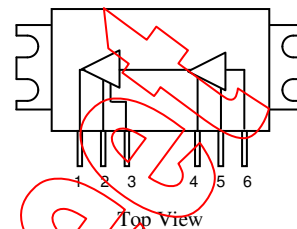

Pin No.	Function
1	RF Output
2/4	Vcc
3/5	Vpd
6	RF Input
Case	Ground

Specifications

W-CDMA 3GPP Test Model 1+64 DPCH, 60% clipping, PAR = 8.6 dB @ 0.01% Probability, 3.84 MHz BW, Vcc = +28V, Icq = 120 mA

Parameter	Units	Min	Typ	Max
Operational Bandwidth	MHz		2110 - 2170	
Output Channel Power	dBm		+23	
Power Gain	dB		28	
ACLR	dBc		-55	
Operating Current, Icc	mA		135	
Collector Efficiency	%		5	
Output P1dB	dBm		+35	
Quiescent Current, Icq	mA		120	
Vpd	V		+5	
Vcc	V		+28	

Absolute Maximum Rating

Parameter	Rating
Operating Case Temperature	-40 to +85 °C
Storage Temperature	-55 to +150 °C

Operation of this device above any of these parameters may cause permanent damage.

Ordering Information

Part No.	Description
AP622	PCS-band 4W HBT Amplifier Module



AP622

UMTS-band 4W HBT Amplifier Module

Evaluation Board Bias Procedure

The following bias procedure is recommended to ensure proper functionality of AP622 in a laboratory environment. The sequencing is not required in the final system application.

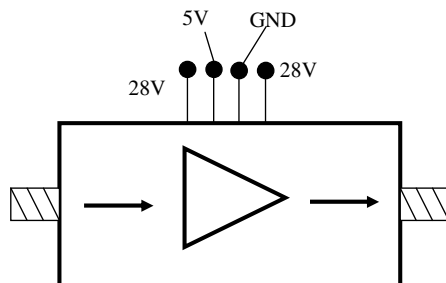

Turn-on Sequence:

1. Attach input and output loads onto the evaluation board.
2. Turn on power supply $V_{cc} = +28V$.
3. Turn on power supply $V_{pd} = +5V$.
4. Turn on RF power.

Turn-off Sequence:

1. Turn off RF power.
2. Turn off power supply $V_{pd} = +5V$.
3. Turn off power supply $V_{cc} = +28V$.

Notes:

1. V_{pd} is used as a reference for the internal active bias circuitry. It can be used to turn on/off the amplifier.



AP622

UMTS-band 4W HBT Amplifier Module

Performance Graphs

W-CDMA 3GPP Test Model 1+64 DPCH, 60% clipping, PAR = 8.6 dB @ 0.01% Probability, 3.84 MHz BW, Vcc = +28V, Icq = 120 mA

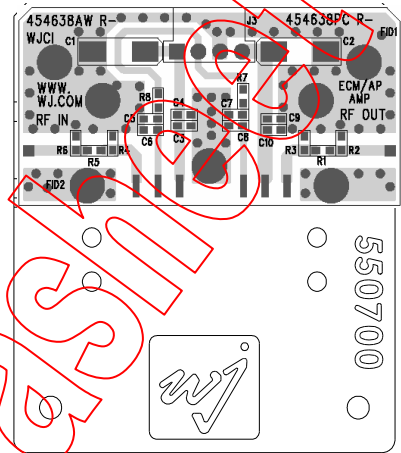
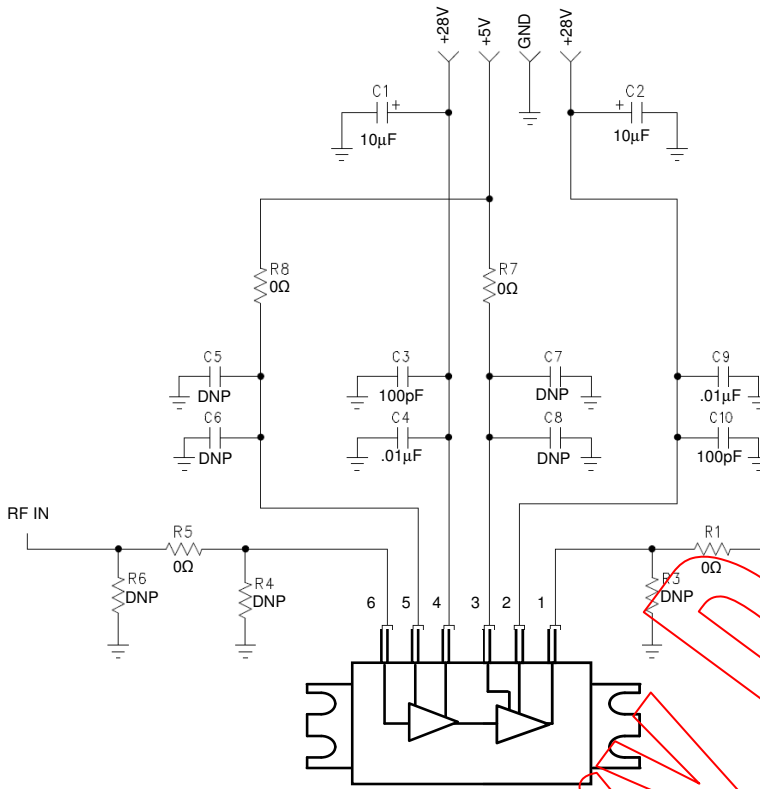

Notes:

1. Please note that for reliable operation, the evaluation board will have to be mounted to a much larger heat sink during operation and in laboratory environments to dissipate the power consumed by the device. The use of a convection fan is also recommended in laboratory environments. Details of the mounting holes used in the WJ heatsink are given on the last page of this datasheet.
2. The area around the module underneath the PCB should not contain any soldermask in order to maintain good RF grounding.
3. For proper and safe operation in the laboratory, the power-on sequencing should be followed:
 - a. Connect RF In and Out
 - b. Connect the voltages and ground pins as shown in the circuit.
 - c. Apply the RF signal
 - d. Power down with the reverse sequence

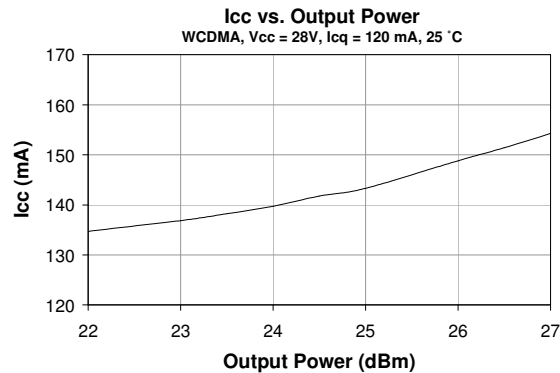
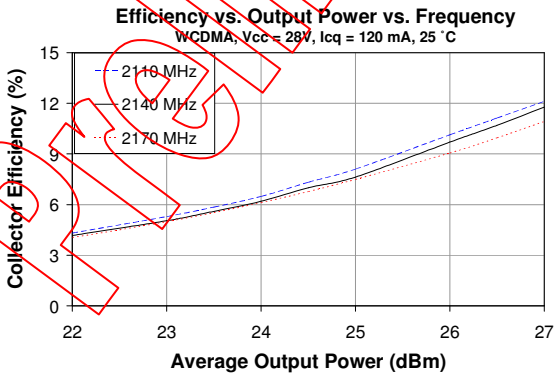
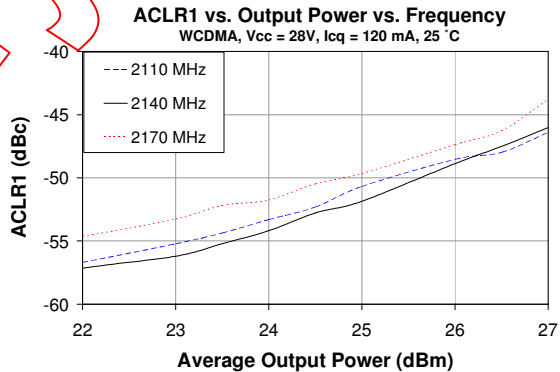
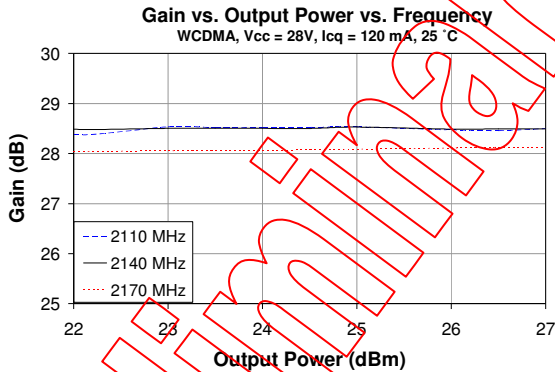



AP622

UMTS-band 4W HBT Amplifier Module

Outline Drawing

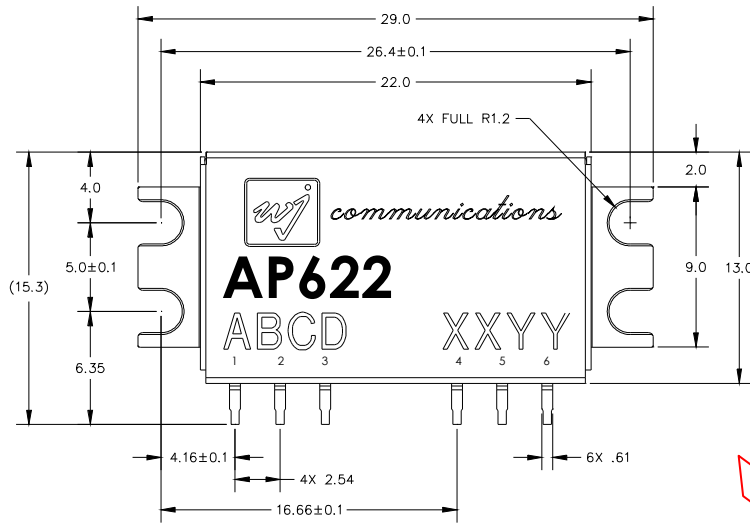

NOTES:

1. DIMENSIONING & TOLERANCING CONFORM TO ANSI Y14.4M-1994.
2. ALL DIMENSIONS ARE IN MILLIMETERS (INCHES). ANGLES ARE IN DEGREES.
3. PIN ASSIGNMENTS:
 [PIN 1] RF OUT
 [PIN 2] +28 Vcc
 [PIN 3] +5 Vpd
 [PIN 4] +28 Vcc
 [PIN 5] +5 Vpd
 [PIN 6] RF IN
 [CASE] GROUND

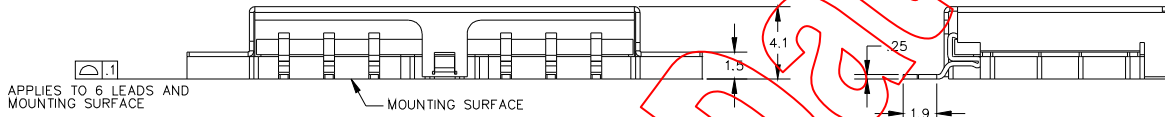

Outline Drawing for the Heatsink with the WJ Evaluation Board

