

LIGHT LOAD IMPROVED 4A 500KHZ SYNCH DC/DC BUCK CONVERTER

Description

The AP65402 is a 500kHz switching frequency external compensated synchronous DC/DC buck converter. It has integrated low $R_{DS(ON)}$ high and low side MOSFETs.

The AP65402 enables continuous load current of up to 4A with efficiency as high as 96%.

The AP65402 implements an automatic custom light load efficiency improvement algorithm.

The AP65402 features current mode control operation, which enables fast transient response times and easy loop stabilization.

The AP65402 simplifies board layout and reduces space requirements with its high level of integration and minimal need for external components, making it ideal for distributed power architectures.

The AP65402 is available in a standard Green SO-8EP package and is RoHS compliant.

Pin Assignments

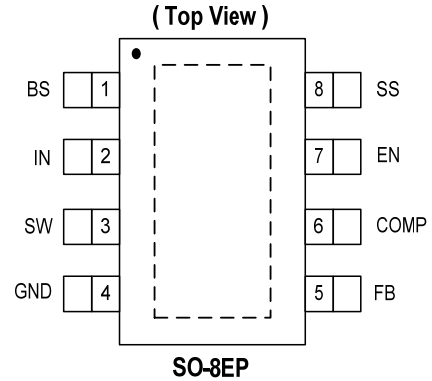

Features

- V_{IN} 4.75V to 17V
- 4A Continuous Output Current, 7A Peak
- Efficiency Up to 96%
- Automated Light Load improvement
- V_{OUT} Adjustable to 0.8 to 12V
- 500kHz Switching Frequency
- External Programmable Soft-Start
- Enable Pin
- OCP with Hiccup and Thermal Protection
- **Totally Lead-Free & Fully RoHS Compliant (Notes 1 & 2)**
- **Halogen and Antimony Free. "Green" Device (Note 3)**

Applications

- Gaming Consoles
- Flat Screen TV sets and Monitors
- Set Top Boxes
- Distributed power systems
- Home Audio
- Consumer electronics
- Network Systems
- FPGA, DSP and ASIC Supplies
- Green Electronics

Notes: 1. No purposely added lead. Fully EU Directive 2002/95/EC (RoHS) & 2011/65/EU (RoHS 2) compliant.
 2. See <http://www.diodes.com> for more information about Diodes Incorporated's definitions of Halogen- and Antimony-free, "Green" and Lead-free.
 3. Halogen- and Antimony-free "Green" products are defined as those which contain <900ppm bromine, <900ppm chlorine (<1500ppm total Br + Cl) and <1000ppm antimony compounds.

Typical Applications Circuit

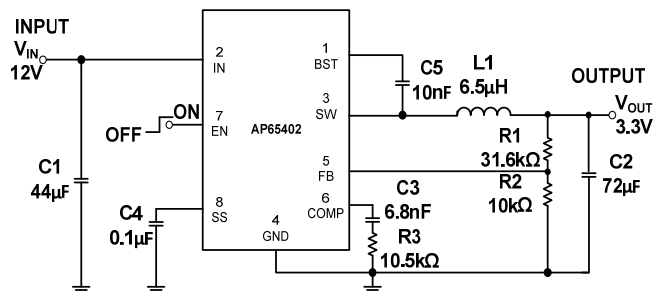
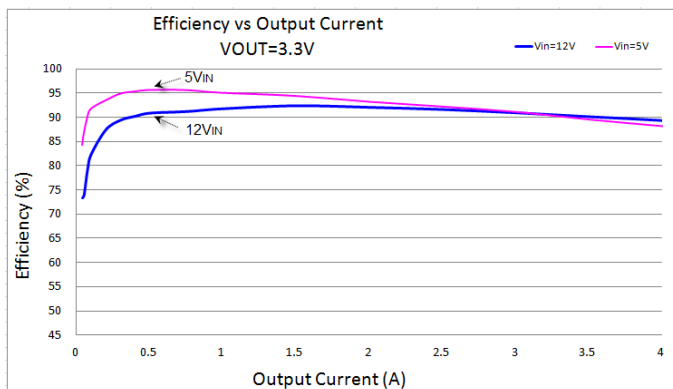

Figure 1. Typical Application Circuit

Pin Descriptions

Pin Name	Pin Number	Function
BS	1	High-Side Gate Drive Boost Input. BS supplies the drive for the high-side N-Channel MOSFET a 0.01µF or greater capacitor from SW to BS to power the high side switch.
IN	2	Power Input. IN supplies the power to the IC, as well as the step-down converter switches. Drive IN with a 4.75V to 17V power source. Bypass IN to GND with a suitably large capacitor to eliminate noise on the input to the IC. See Input Capacitor.
SW	3	Power Switching Output. SW is the switching node that supplies power to the output. Connect the output LC filter from SW to the output load. Note that a capacitor is required from SW to BS to power the high-side switch.
GND	4	Ground
FB	5	Feedback Input. FB senses the output voltage and regulates it. Drive FB with a resistive voltage divider connected to it from the output voltage. The feedback threshold is 0.800V. See Setting the Output Voltage.
COMP	6	Compensation Node. COMP is used to compensate the regulation control loop. Connect a series RC network from COMP to GND. In some cases, an additional capacitor from COMP to GND is required. See Compensation Components.
EN	7	Enable Input. EN is a digital input that turns the regulator on or off. Drive EN high to turn on the regulator; low to turn it off. Attach to IN with a 100kΩ pull up resistor for automatic startup.
SS	8	Soft-Start Control Input. SS controls the soft-start period. Connect a capacitor from SS to GND to set the soft-start period. A 0.1µF capacitor sets the soft-start period to 13ms. To disable the soft-start feature, leave SS floating.
EP	EP	Exposed Pad is connected to ground.

Functional Block Diagram

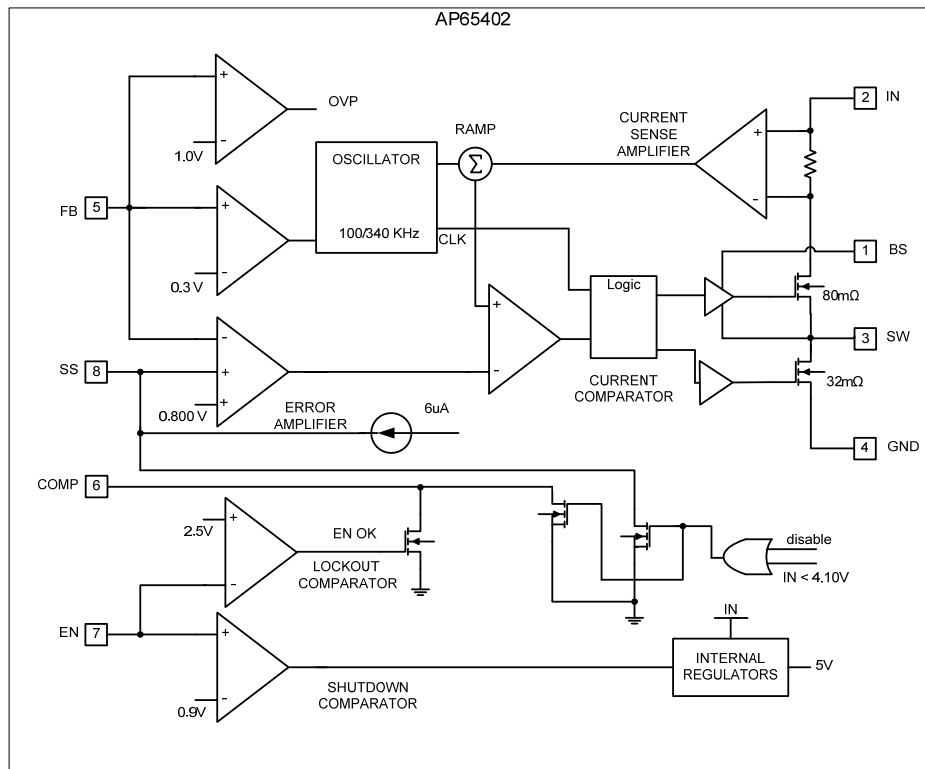

Figure 2. Functional Block Diagram

Absolute Maximum Ratings (Note 4) (@T_A = +25°C, unless otherwise specified.)

Symbol	Parameter	Rating	Unit
V _{IN}	Supply Voltage	-0.3 to 20	V
V _{SW}	Switch Node Voltage	-1.0 to V _{IN} +0.3	V
V _{BS}	Bootstrap Voltage	V _{SW} -0.3 to V _{SW} +6.0	V
V _{FB}	Feedback Voltage	-0.3V to +6.0	V
V _{EN}	Enable/UVLO Voltage	-0.3V to +6.0	V
V _{COMP}	Comp Voltage	-0.3V to +6.0	V
T _{ST}	Storage Temperature	-65 to +150	°C
T _J	Junction Temperature	+160	°C
T _L	Lead Temperature	+260	°C
ESD Susceptibility (Note 5)			
HBM	Human Body Model	1.5	kV
MM	Machine Model	150	V

- Notes:
- Stresses greater than the 'Absolute Maximum Ratings' specified above may cause permanent damage to the device. These are stress ratings only; functional operation of the device at these or any other conditions exceeding those indicated in this specification is not implied. Device reliability may be affected by exposure to absolute maximum rating conditions for extended periods of time.
 - Semiconductor devices are ESD sensitive and may be damaged by exposure to ESD events. Suitable ESD precautions should be taken when handling and transporting these devices.

Thermal Resistance

Symbol	Parameter	Rating		Unit
θ _{JA}	Junction to Ambient	SO-8EP (Note 6)	39.2	°C/W
θ _{JC}	Junction to Case	SO-8EP (Note 6)	5.6	°C/W

- Note:
- Test condition: SO-8EP: Device mounted on FR-4 substrate (2s2p) 2"x2" PCB, with 2oz copper trace thickness and minimum recommended pad on top layer and thermal vias to bottom layer ground plane.

Recommended Operating Conditions (Note 7) (@T_A = +25°C, unless otherwise specified.)

Symbol	Parameter	Min	Max	Unit
V _{IN}	Supply Voltage	4.75	17.0	V
T _A	Operating Ambient Temperature Range	-40	+85	°C

- Note:
- The device function is not guaranteed outside of the recommended operating conditions.

Electrical Characteristics (@ $T_A = +25^\circ\text{C}$, $V_{IN} = 12\text{V}$, unless otherwise specified.)

Symbol	Parameter	Test Conditions	Min	Typ	Max	Unit
I_{SHDN}	Shutdown Supply Current	$V_{EN} = 0\text{V}$	—	0.3	3.0	μA
I_Q	Supply Current (Quiescent)	$V_{EN} = 2.0\text{V}$, $V_{FB} = 1.0\text{V}$	—	0.3	1.5	mA
$R_{DS(ON)1}$	High-Side Switch On-Resistance (Note 8)	—	—	80	—	$\text{m}\Omega$
$R_{DS(ON)2}$	Low-Side Switch On-Resistance (Note 8)	—	—	32	—	$\text{m}\Omega$
I_{LIMIT}	HS Current Limit	Minimum duty cycle	—	7	—	A
I_{LIMIT}	LS Current Limit	From Drain to Source	—	0.9	—	A
—	High-Side Switch Leakage Current	$V_{EN} = 0\text{V}$, $V_{SW} = 0\text{V}$, $V_{SW} = 12\text{V}$	—	0	10	μA
AVEA	Error Amplifier Voltage Gain (Note 8)	—	—	800	—	V/V
GEA	Error Amplifier Transconductance	$\Delta I_C = \pm 10\mu\text{A}$	—	1000	—	$\mu\text{A/V}$
GCS	COMP to Current Sense Transconductance	—	—	2.8	—	A/V
F_{SW}	Oscillator Frequency	$V_{FB} = 0.75\text{V}$	440	500	560	kHz
F_{FB}	Fold-back Frequency	$V_{FB} = 0\text{V}$	—	0.30	—	f_{sw}
D_{MAX}	Maximum Duty Cycle	$V_{FB} = 800\text{mV}$	—	90	—	%
T_{ON}	Minimum On Time	—	—	160	—	ns
V_{FB}	Feedback Voltage	$T_A = -40^\circ\text{C}$ to $+85^\circ\text{C}$	—	800	—	mV
—	Feedback Overvoltage Threshold	—	—	1.0	—	V
V_{EN_RISING}	EN Rising Threshold	—	0.7	0.8	1.2	V
—	EN Lockout Threshold Voltage	—	2.2	2.5	2.7	V
—	EN Lockout Hysteresis	—	—	220	—	mV
$INUV_{VTH}$	V_{IN} Under Voltage Threshold Rising	—	3.80	4.05	4.40	V
$INUV_{HYS}$	V_{IN} Under Voltage Threshold Hysteresis	—	—	250	—	mV
—	Soft-Start Current	$V_{SS} = 0\text{V}$	—	6	—	μA
—	Soft-Start Period	$C_{SS} = 0.1\mu\text{F}$	—	13	—	ms
T_{SD}	Thermal Shutdown (Note 8)	—	—	160	—	$^\circ\text{C}$

Note: 8. Guaranteed by design

Typical Performance Characteristics (@ $T_A = +25^\circ\text{C}$, $V_{IN} = 12\text{V}$, $V_{OUT} = 3.3\text{V}$, unless otherwise specified.)

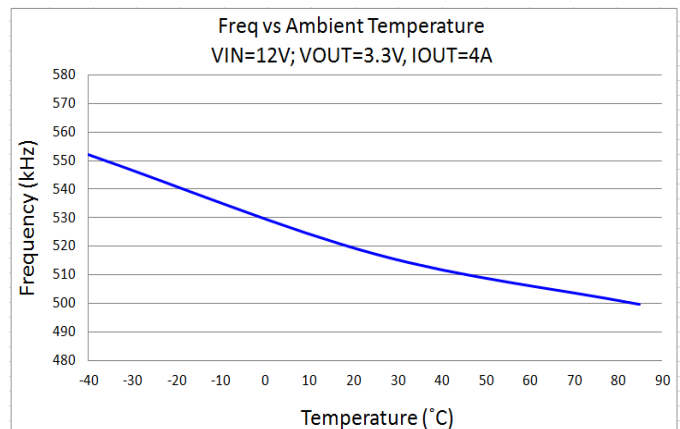
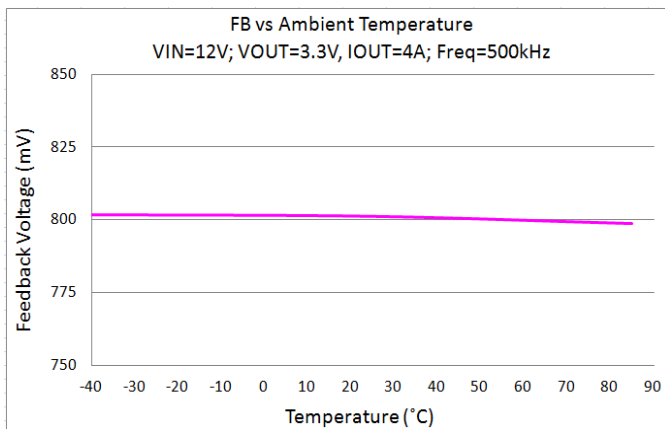
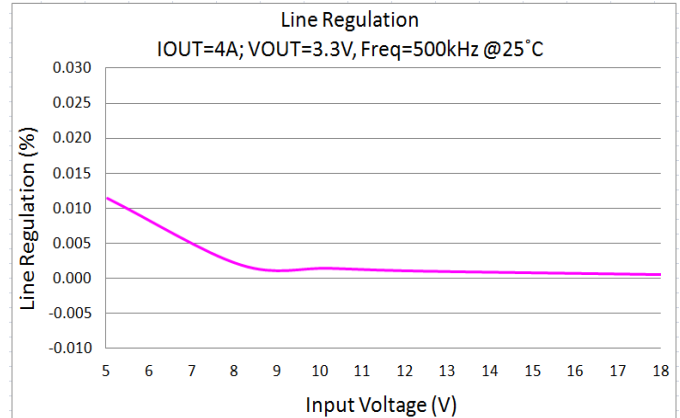
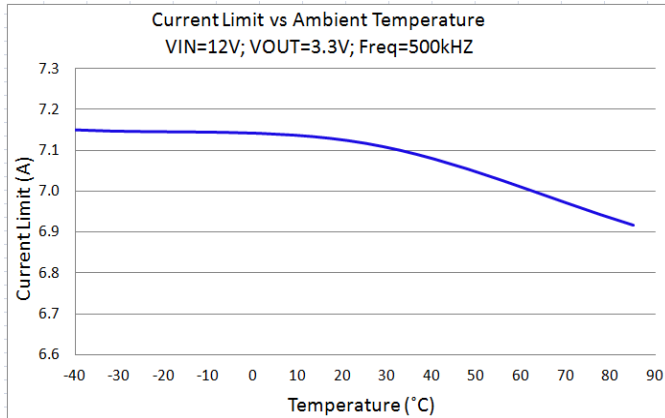
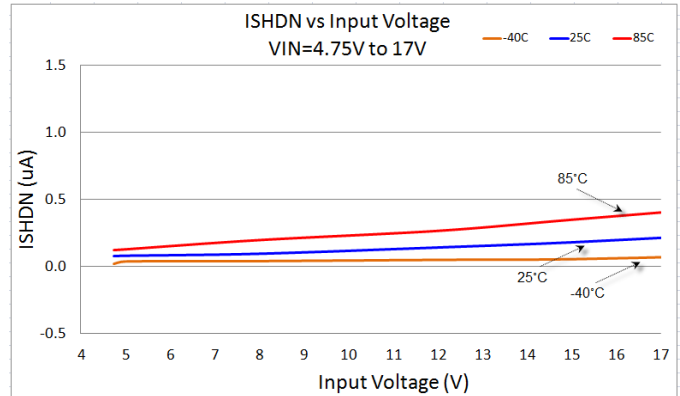
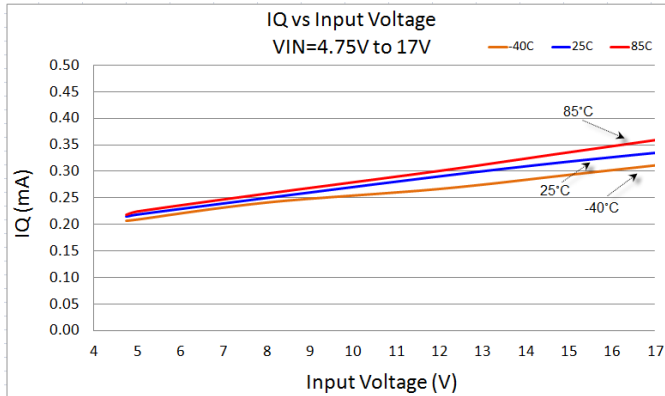

Typical Performance Characteristics (cont.) (@ $T_A = +25^\circ\text{C}$, $V_{IN} = 12\text{V}$, $V_{OUT} = 3.3\text{V}$, unless otherwise specified.)

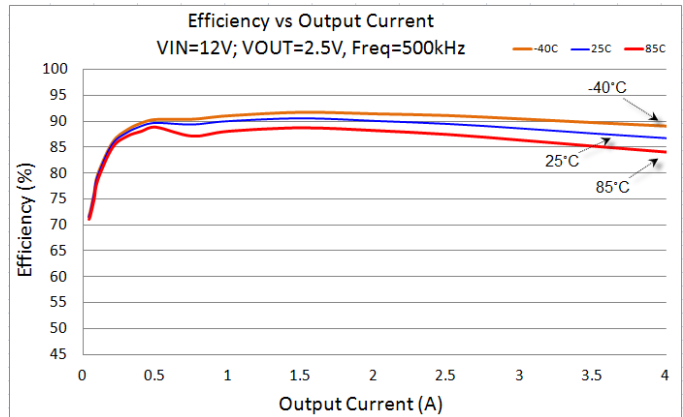
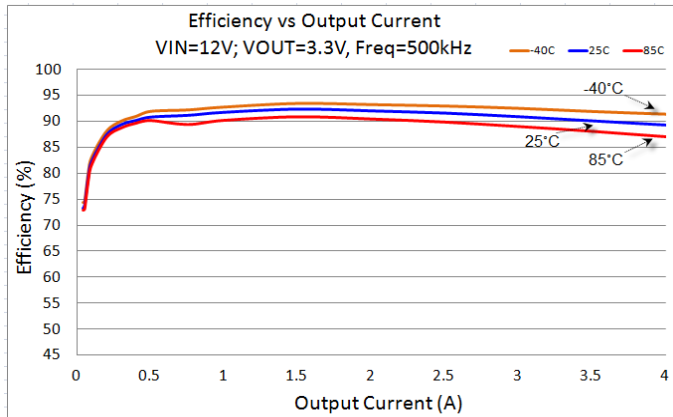
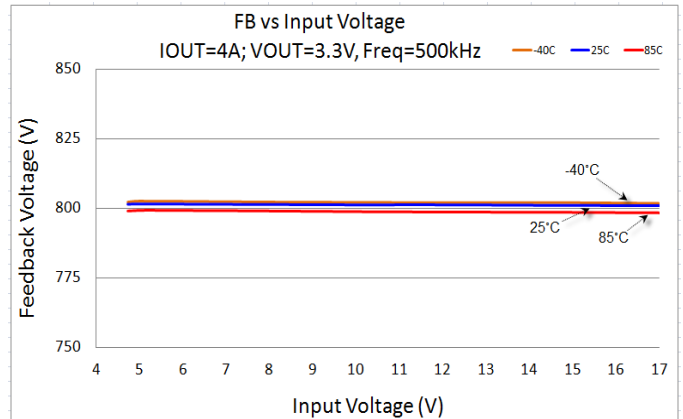
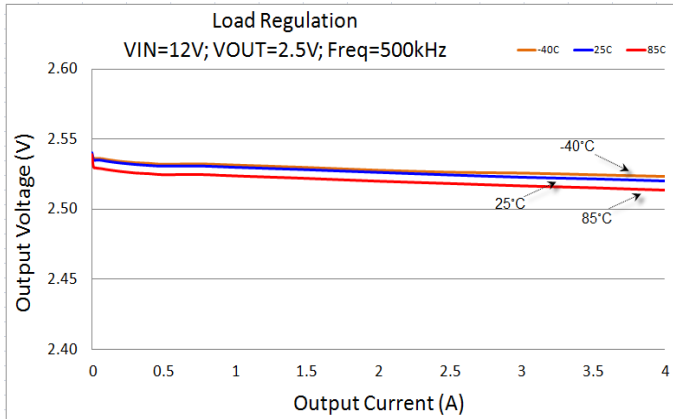

Typical Performance Characteristics (cont.)

(@T_A = +25°C, V_{IN} = 12V, V_{OUT} = 3.3V, L = 6.5μH, C1 = 22μF, C2 = 47μF, unless otherwise specified.)

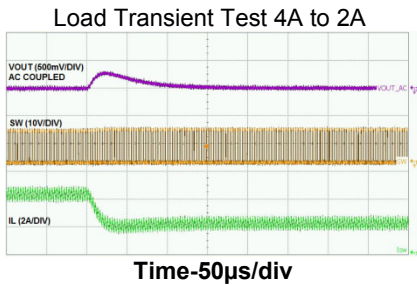
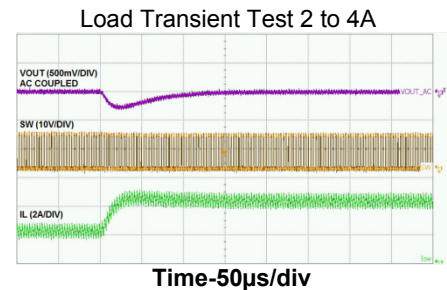
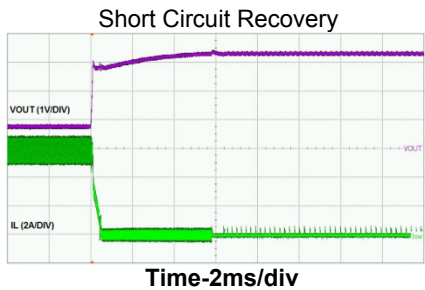
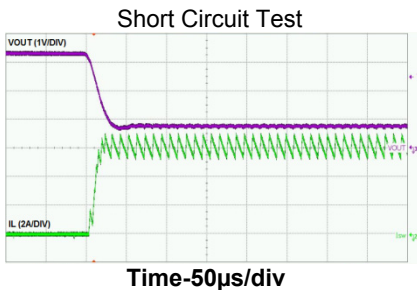
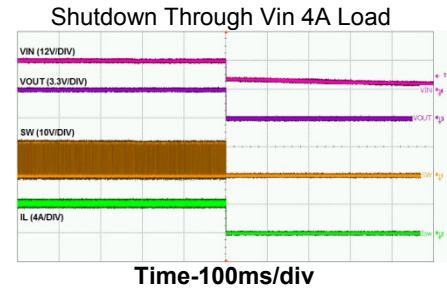
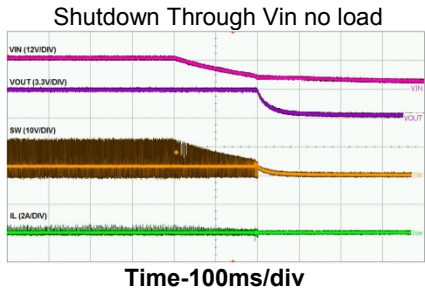
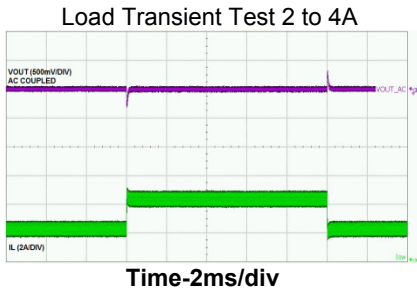
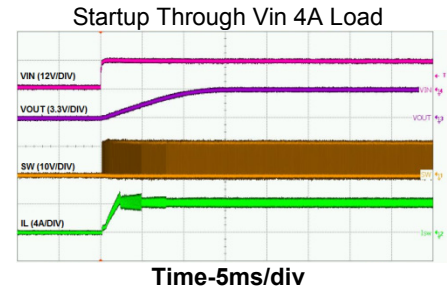
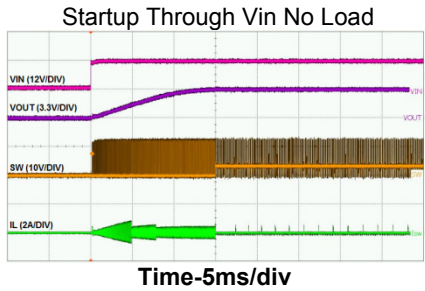
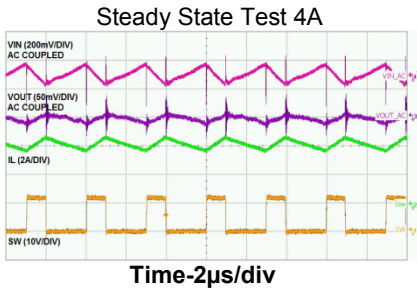

Application Information

Theory of Operation

The AP65402 is a 4A current mode control, synchronous buck regulator with built in power MOSFETs. Current mode control assures excellent line and load regulation and a wide loop bandwidth for fast response to load transients. The Figure 1 depicts the functional block diagram of AP65402.

The operation of one switching cycle can be explained as follows. At the beginning of each cycle, HS (high-side) MOSFET is off. The error amplifier (EA) output voltage is higher than the current sense amplifier output, and the current comparator's output is low. The rising edge of the 500kHz oscillator clock signal sets the RS Flip-Flop. Its output turns on HS MOSFET. The current sense amplifier is reset for every switching cycle.

When the HS MOSFET is on, inductor current starts to increase. The current sense amplifier senses and amplifies the inductor current. Since the current mode control is subject to sub-harmonic oscillations that peak at half the switching frequency, ramp slope compensation is utilized. This will help to stabilize the power supply. This ramp compensation is summed to the current sense amplifier output and compared to the error amplifier output by the PWM comparator. When the sum of the current sense amplifier output and the slope compensation signal exceeds the EA output voltage, the RS Flip-Flop is reset and HS MOSFET is turned off.

For one whole cycle, if the sum of the current sense amplifier output and the slope compensation signal does not exceed the EA output, then the falling edge of the oscillator clock resets the Flip-Flop. The output of the error amplifier increases when feedback voltage (VFB) is lower than the reference voltage of 0.8V. This also increases the inductor current as it is proportional to the comp voltage.

If in one cycle the current in the power MOSFET does not reach the COMP set current value, the power MOSFET will be forced to turn off. When the HS MOSFET turns off, the synchronous LS MOSFET turns on until the next clock cycle begins. There is a "dead time" between the HS turn off and LS turn on that prevents the switches from "shooting through" from the input supply to ground.

The voltage loop is compensated through an internal transconductance amplifier and can be adjusted through the external compensation components.

Enable

Above the 'EN Rising Threshold', the internal regulator is turned on and the quiescent current can be measured above this threshold. The enable (EN) input allows the user to control turning on or off the regulator. To enable the AP65402, EN must be pulled above the 'EN Lockout Threshold Voltage' and to disable the AP65402, EN must be pulled below 'EN Lockout Threshold Voltage - EN Lockout Hysteresis' (2.2V-0.22V =1.98V).

Automated No-Load and Light-Load Operation

The AP65402 operates in Light load high efficiency mode during light load operation. The advantage of this light load high efficiency mode is low power loss at no-load and light-load conditions. The AP65402 automatically detects the output current and enters the light load high efficiency mode. The output current reaches a critical level at which the transitions between the light-load and heavy current mode occurs. Once the output current exceeds the critical level, the AP65402 transitions from light load high efficiency mode to continuous PWM mode.

External Soft Start

Soft start is traditionally implemented to prevent the excess inrush current. This in turn prevents the converter output voltage from overshooting when it reaches regulation. The AP65402 has an internal current source with a soft start capacitor to ramp the reference voltage from 0V to 0.800V. The soft start current is 6µA. The soft start sequence is reset when there is a Thermal Shutdown, Under Voltage Lockout (UVLO) or when the part is disabled using the EN pin.

External Soft Start can be calculated from the formula below:

$$I_{SS} = C * \frac{DV}{DT}$$

Where;

I_{SS} = Soft Start Current

C = External Capacitor

DV=change in feedback voltage from 0V to maximum voltage

DT = Soft Start Time

Application Information (cont.)

Current Limit Protection

In order to reduce the total power dissipation and to protect the application, AP65402 has cycle-by-cycle current limiting implementation. The voltage drop across the internal high-side MOSFET is sensed and compared with the internally set current limit threshold. This voltage drop is sensed at about 30ns after the HS turns on. When the peak inductor current exceeds the set current limit threshold, current limit protection is activated. During this time the feedback voltage (VFB) drops down. When the voltage at the FB pin reaches 0.3V, the internal oscillator shifts the frequency from the normal operating frequency of 500kHz to a fold-back frequency of 102kHz. The current limit is reduced to 70% of nominal current limit when the part is operating at 102kHz. This low fold-back frequency prevents runaway current.

Under Voltage Lockout (UVLO)

Under Voltage Lockout is implemented to prevent the IC from insufficient input voltages. The AP65402 has a UVLO comparator that monitors the input voltage and the internal bandgap reference. If the input voltage falls below 4.0V, the AP65402 will latch an under voltage fault. In this event the output will be pulled low and power has to be re-cycled to reset the UVLO fault.

Over Voltage Protection

When the AP65402 FB pin exceeds 20% of the nominal regulation voltage of 0.800V, the over voltage comparator is tripped and the COMP pin and the SS pin are discharged to GND, forcing the high-side switch off.

Thermal Shutdown

The AP65402 has on-chip thermal protection that prevents damage to the IC when the die temperature exceeds safe margins. It implements a thermal sensing to monitor the operating junction temperature of the IC. Once the die temperature rises to approximately +160°C, the thermal protection feature gets activated. The internal thermal sense circuitry turns the IC off thus preventing the power switch from damage.

A hysteresis in the thermal sense circuit allows the device to cool down to approximately +120°C before the IC is enabled again through soft start. This thermal hysteresis feature prevents undesirable oscillations of the thermal protection circuit.

Setting the Output Voltage

The output voltage can be adjusted from 0.800V to 16V using an external resistor divider. Table 1 shows a list of resistor selection for common output voltages. Resistor R1 is selected based on a design tradeoff between efficiency and output voltage accuracy. For high values of R1 there is less current consumption in the feedback network. However the trade off is output voltage accuracy due to the bias current in the error amplifier. R1 can be determined by the following equation:

$$R_1 = R_2 \cdot \left(\frac{V_{OUT}}{0.8} - 1 \right)$$

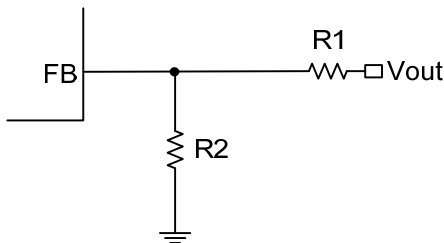

Figure 3. Feedback Divider Network

V _{OUT} (V)	R ₁ (kΩ)	R ₂ (kΩ)
5	52.3	10
3.3	31.6	10
2.5	21.5	10
1.8	12.4	10
1.2	5	10

Table 1. Resistor Selection for Common Output Voltages

Application Information (cont.)

Compensation Components

The AP65402 has an external COMP pin through which system stability and transient response can be controlled. COMP pin is the output of the internal trans-conductance error amplifier. A series capacitor-resistor combination sets a pole-zero combination to control the characteristics of the control system. The DC gain of the voltage feedback loop is given by:

$$A_{VDC} = R_{LOAD} \times G_{CS} \times A_{VEA} \times \frac{V_{FB}}{V_{OUT}}$$

Where V_{FB} is the feedback voltage (0.800V), R_{LOAD} is the load resistor value, G_{CS} is the current sense trans-conductance and A_{VEA} is the error amplifier voltage gain. The control loop transfer function incorporates two poles one is due to the compensation capacitor (C3) and the output resistor of error amplifier, and the other is due to the output capacitor and the load resistor. These poles are located at:

$$f_{P1} = \frac{G_{EA}}{2\pi \times C3 \times A_{VEA}} \quad f_{P2} = \frac{1}{2\pi \times C2 \times R_{LOAD}}$$

Where G_{EA} is the error amplifier trans-conductance.

One zero is present due to the compensation capacitor (C3) and the compensation resistor (R3). This zero is located at:

$$f_{Z1} = \frac{1}{2\pi \times C3 \times R3}$$

The goal of compensation design is to shape the converter transfer function to get a desired loop gain. The system crossover frequency where the feedback loop has the unity gain is crucial.

A rule of thumb is to set the crossover frequency to below one-tenth of the switching frequency. Use the following procedure to optimize the compensation components:

1. Choose the compensation resistor (R3) to set the desired crossover frequency. Determine the R3 value by the following equation:

$$R3 = \frac{2\pi \times C2 \times f_c}{G_{EA} \times G_{CS}} \times \frac{V_{OUT}}{V_{FB}} < \frac{2\pi \times C2 \times 0.1 \times f_s}{G_{EA} \times G_{CS}} \times \frac{V_{OUT}}{V_{FB}}$$

Where f_c is the crossover frequency, which is typically less than one tenth of the switching frequency.

2. Choose the compensation capacitor (C3) to achieve the desired phase margin set the compensation zero, f_{z1} , to below one fourth of the crossover frequency to provide sufficient phase margin. Determine the C3 value by the following equation:

$$C3 > \frac{2}{\pi \times R3 \times f_c}$$

Where R3 is the compensation resistor value.

VOUT (V)	Cin/C1 (μF)	Cout/C2 (μF)	Rc/R3 (kΩ)	Cc/C3 (nF)	L1 (μH)
1.2	44	72	10.5	6.8	4.7
1.8	44	72	10.5	6.8	4.7
2.5	44	72	10.5	6.8	6.5
3.3	44	72	10.5	6.8	6.5
5	44	72	10.5	6.8	6.5
12	44	72	10.5	6.8	10

Table 2. Recommended Component Selection

Inductor

Calculating the inductor value is a critical factor in designing a buck converter. For most designs, the following equation can be used to calculate the inductor value;

$$L = \frac{V_{OUT} \cdot (V_{IN} - V_{OUT})}{V_{IN} \cdot \Delta I_L \cdot f_{SW}}$$

Where ΔI_L is the inductor ripple current.

And f_{SW} is the buck converter switching frequency.

Application Information (cont.)

Inductor (cont.)

Choose the inductor ripple current to be 30% of the maximum load current. The maximum inductor peak current is calculated from:

$$I_{L(MAX)} = I_{LOAD} + \frac{\Delta I_L}{2}$$

Peak current determines the required saturation current rating, which influences the size of the inductor. Saturating the inductor decreases the converter efficiency while increasing the temperatures of the inductor and the internal MOSFETs. Hence choosing an inductor with appropriate saturation current rating is important.

A 1μH to 10μH inductor with a DC current rating of at least 25% percent higher than the maximum load current is recommended for most applications.

For highest efficiency, the inductor's DC resistance should be less than 100mΩ. Use a larger inductance for improved efficiency under light load conditions.

Input Capacitor

The input capacitor reduces the surge current drawn from the input supply and the switching noise from the device. The input capacitor has to sustain the ripple current produced during the on time on the upper MOSFET. It must hence have a low ESR to minimize the losses.

The RMS current rating of the input capacitor is a critical parameter that must be higher than the RMS input current. As a rule of thumb, select an input capacitor which has RMS rating that is greater than half of the maximum load current.

Due to large di/dt through the input capacitors, electrolytic or ceramics should be used. If a tantalum must be used, it must be surge protected. Otherwise, capacitor failure could occur. For most applications, a 44μF ceramic capacitor is sufficient.

Output Capacitor

The output capacitor keeps the output voltage ripple small, ensures feedback loop stability and reduces the overshoot of the output voltage. The output capacitor is a basic component for the fast response of the power supply. In fact, during load transient, for the first few microseconds it supplies the current to the load. The converter recognizes the load transient and sets the duty cycle to maximum, but the current slope is limited by the inductor value.

Maximum capacitance required can be calculated from the following equation:

ESR of the output capacitor dominates the output voltage ripple. The amount of ripple can be calculated from the equation below:

$$V_{out_capacitor} = \Delta I_{inductor} * ESR$$

An output capacitor with ample capacitance and low ESR is the best option. For most applications, a 72μF ceramic capacitor will be sufficient.

$$C_o = \frac{L(I_{out} + \frac{\Delta I_{inductor}}{2})^2}{(\Delta V + V_{out})^2 - V_{out}^2}$$

Where ΔV is the maximum output voltage overshoot.

Application Information (cont.)

PC Board Layout

This is a high switching frequency converter. Hence attention must be paid to the switching currents interference in the layout. Switching current from one power device to another can generate voltage transients across the impedances of the interconnecting bond wires and circuit traces. These interconnecting impedances should be minimized by using wide, short printed circuit traces. Note that the IN to GND decoupling capacitors need to be immediately adjacent to the IN and GND pins of the device (U1), and 12 thermal vias from the back side thermal pad to the GND plane are essential to achieve the best operation at full load current.

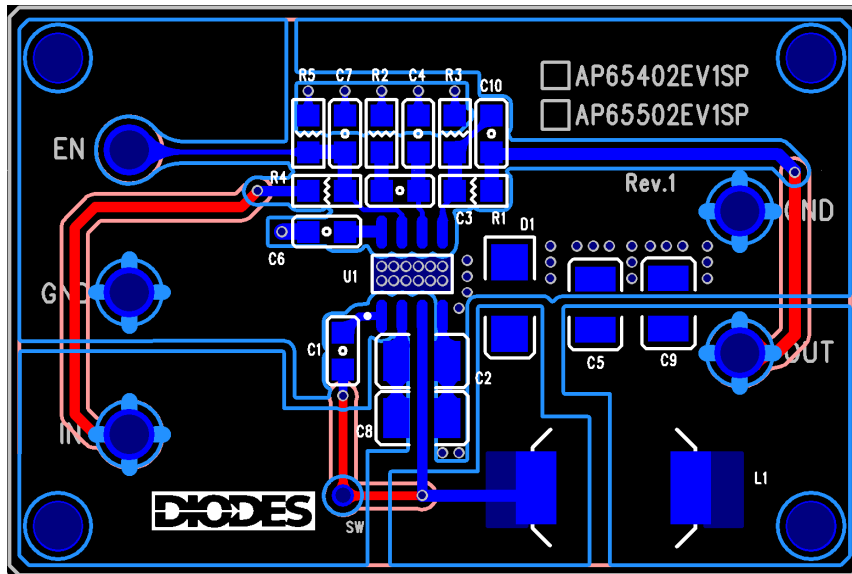

Figure 4. PC Board Layout

External Bootstrap Diode

It is recommended that an external bootstrap diode be added when the input voltage is no greater than 5V or the 5V rail is available in the system. This helps to improve the efficiency of the regulator. This solution is also applicable for $D > 65\%$. The bootstrap diode can be a low cost one such as BAT54 or a Schottky that has a low V_F .

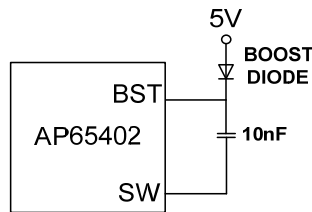
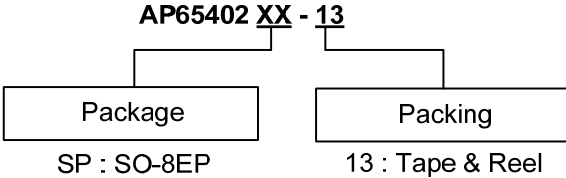

Figure 5—External Bootstrap Compensation Components

Recommended Diodes:

Part Number	Voltage/Current Rating	Vendor
B130	30V, 1A	Diodes Inc
SK13	30V, 1A	Diodes Inc

Ordering Information



Part Number	Package Code	Part Marking	Identification Code	Tape and Reel	
				Quantity	Part Number Suffix
AP65402SP-13	SP	SO-8EP	NA	2500	-13

Note: 9. For packaging details, go to our website at <http://www.diodes.com/products/packages.html>

Marking Information

SO-8EP

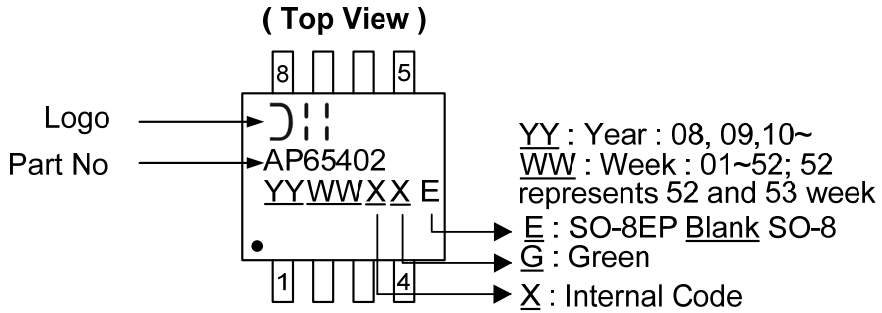

Package Outline Dimensions (All dimensions in mm.)

Please see AP02002 at <http://www.diodes.com/datasheets/ap02002.pdf> for latest version.

SO-8EP

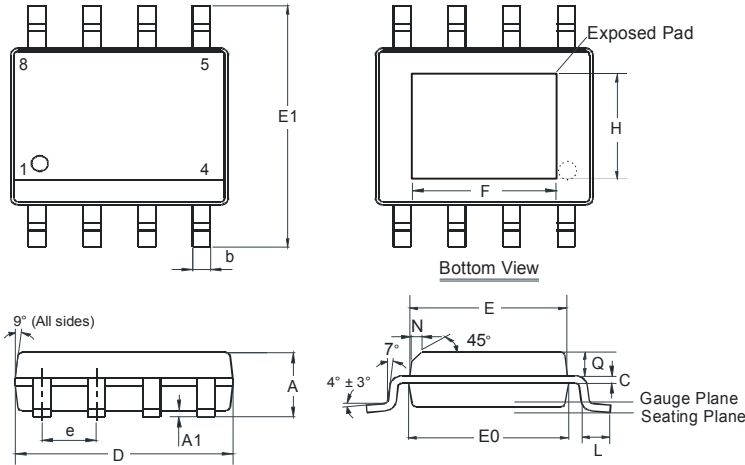

SO-8EP (SOP-8L-EP)			
Dim	Min	Max	Typ
A	1.40	1.50	1.45
A1	0.00	0.13	-
b	0.30	0.50	0.40
C	0.15	0.25	0.20
D	4.85	4.95	4.90
E	3.80	3.90	3.85
E0	3.85	3.95	3.90
E1	5.90	6.10	6.00
e	-	-	1.27
F	2.75	3.35	3.05
H	2.11	2.71	2.41
L	0.62	0.82	0.72
N	-	-	0.35
Q	0.60	0.70	0.65
All Dimensions in mm			

Suggested Pad Layout

Please see AP02001 at <http://www.diodes.com/datasheets/ap02001.pdf> for the latest version.

SO-8EP

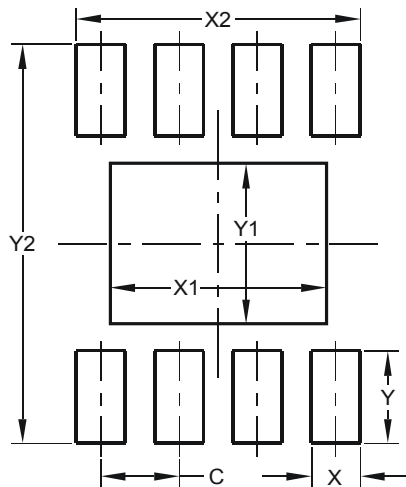

Dimensions	Value (in mm)
C	1.270
X	0.802
X1	3.502
X2	4.612
Y	1.505
Y1	2.613
Y2	6.500

IMPORTANT NOTICE

DIODES INCORPORATED MAKES NO WARRANTY OF ANY KIND, EXPRESS OR IMPLIED, WITH REGARDS TO THIS DOCUMENT, INCLUDING, BUT NOT LIMITED TO, THE IMPLIED WARRANTIES OF MERCHANTABILITY AND FITNESS FOR A PARTICULAR PURPOSE (AND THEIR EQUIVALENTS UNDER THE LAWS OF ANY JURISDICTION).

Diodes Incorporated and its subsidiaries reserve the right to make modifications, enhancements, improvements, corrections or other changes without further notice to this document and any product described herein. Diodes Incorporated does not assume any liability arising out of the application or use of this document or any product described herein; neither does Diodes Incorporated convey any license under its patent or trademark rights, nor the rights of others. Any Customer or user of this document or products described herein in such applications shall assume all risks of such use and will agree to hold Diodes Incorporated and all the companies whose products are represented on Diodes Incorporated website, harmless against all damages.

Diodes Incorporated does not warrant or accept any liability whatsoever in respect of any products purchased through unauthorized sales channel. Should Customers purchase or use Diodes Incorporated products for any unintended or unauthorized application, Customers shall indemnify and hold Diodes Incorporated and its representatives harmless against all claims, damages, expenses, and attorney fees arising out of, directly or indirectly, any claim of personal injury or death associated with such unintended or unauthorized application.

Products described herein may be covered by one or more United States, international or foreign patents pending. Product names and markings noted herein may also be covered by one or more United States, international or foreign trademarks.

This document is written in English but may be translated into multiple languages for reference. Only the English version of this document is the final and determinative format released by Diodes Incorporated.

LIFE SUPPORT

Diodes Incorporated products are specifically not authorized for use as critical components in life support devices or systems without the express written approval of the Chief Executive Officer of Diodes Incorporated. As used herein:

A. Life support devices or systems are devices or systems which:

1. are intended to implant into the body, or
2. support or sustain life and whose failure to perform when properly used in accordance with instructions for use provided in the labeling can be reasonably expected to result in significant injury to the user.

B. A critical component is any component in a life support device or system whose failure to perform can be reasonably expected to cause the failure of the life support device or to affect its safety or effectiveness.

Customers represent that they have all necessary expertise in the safety and regulatory ramifications of their life support devices or systems, and acknowledge and agree that they are solely responsible for all legal, regulatory and safety-related requirements concerning their products and any use of Diodes Incorporated products in such safety-critical, life support devices or systems, notwithstanding any devices- or systems-related information or support that may be provided by Diodes Incorporated. Further, Customers must fully indemnify Diodes Incorporated and its representatives against any damages arising out of the use of Diodes Incorporated products in such safety-critical, life support devices or systems.

Copyright © 2014, Diodes Incorporated

www.diodes.com