



FEATURES

- Low Dropout Voltage of 250mV at 300mA
- Guaranteed 300mA Output Current
- Very Low Quiescent Current at 30µA
- ±2% Output Voltage Accuracy
- Needs Only 1µF Capacitor for Stability
- Thermal Shutdown Protection
- Current Limit Protection
- Low-ESR Ceramic Capacitor for Output Stability
- Tiny Package: SOT-23, SOT-89
- RoHS Compliant & Halogen Free

DESCRIPTION

The APE8800 series are low dropout, positive linear regulators with very low quiescent current. The APE8800 can supply 300mA output current with a low dropout voltage at about 250mV.

The APE8800 regulator is able to operate with output capacitors as small as 1 µ F for stability. Other than the current limit protection APE8800 also offers on chip thermal shutdown feature providing protection against overload or any condition when the ambient temperature exceeds the junction temperature.

The APE8800 series are offering three different fixed output voltage types including 1.5V, 1.8V, 2.5V, 2.8V, 3V, 3.3 & 3.6 volt.

The APE8800 series are available in low-profile, space-saving 3-lead SOT-23 and SOT-89 packages.

APPLICATIONS

- DVD/CD-ROMs, CD/RWs
- Wireless Devices
- LCD Modules
- Battery Power Systems
- Card Readers
- XDSL Routers

TYPICAL APPLICATION

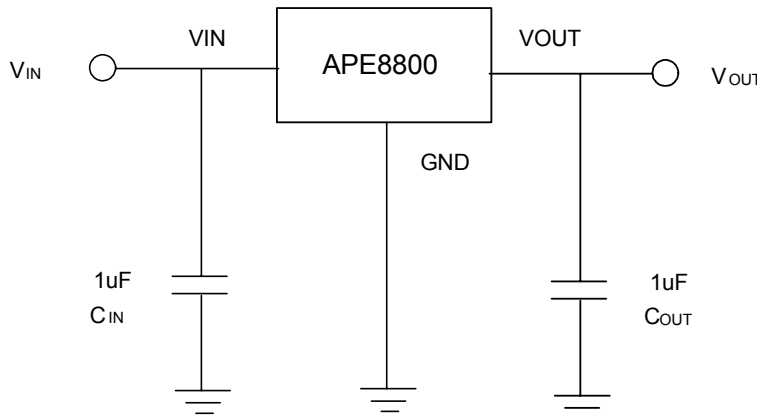
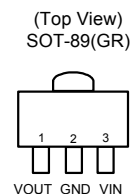
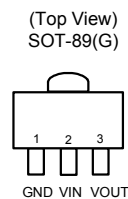
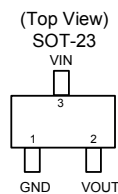

Figure 1. Typical Application Circuit of APE8800

Note : To prevent oscillation, it is recommended to use minimum 1µF X7R or X5R dielectric capacitors if ceramics are used as input/output capacitors.

ORDERING / PACKAGE INFORMATION

APE8800X - X	
Package Type	Output Voltage
N : SOT-23	15 : 1.5V ; 30 : 3.0V
G : SOT-89	18 : 1.8V ; 33 : 3.3V
GR : SOT-89	25 : 2.5V ; 36 : 3.6V
	28 : 2.8V





ABSOLUTE MAXIMUM RATINGS

Supply Input Voltage (V_{IN})	-----	6V
Power Dissipation	-----	
	SOT-23 -----	0.4W
	SOT-89 -----	0.57W
Storage Temperature Range (T_{stg})	-----	-65°C To 150°C
Maximum Junction Temperature (T_J)	-----	150°C
Lead Temperature (Soldering, 10sec, T_{LEAD})	-----	260°C
Thermal Resistance Junction to Ambient (R_{thja})		
	SOT-23 -----	250°C/W
	SOT-89 -----	175°C/W

Note : Stresses beyond those listed under "Absolute Maximum Ratings" may cause permanent damage to the device.

RECOMMENDED OPERATING CONDITIONS

Input Voltage (V_{IN})	-----	2.8 to 5.5V
Operating Junction Temperature Range (T_J)	-----	-40 to 125°C
Ambient Temperature (T_A)	-----	-40 to 125°C

ELECTRICAL SPECIFICATIONS

($V_{IN}=V_{OUT}+1V$ or $V_{IN}=2.8V$ whichever is greater, $C_{IN}=1\mu F$, $C_{OUT}=1\mu F$, $T_A=25^\circ C$, unless otherwise specified)

Parameter	SYM	TEST CONDITION	MIN	TYP	MAX	UNITS	
Output Voltage Accuracy	ΔV_{OUT}	$I_O=1mA$	-2	-	2	%	
Current Limit	I_{LIMIT}	$R_{Load}=1\Omega$	300	-	-	mA	
Quiescent Current	I_Q	$I_O=0mA$	-	30	55	μA	
Dropout Voltage (Note 1)	V_{DROP}	$I_O=300mA$	$1.2V \leq V_{OUT} \leq 2.0V$	-	1100	-	mV
			$2.0V < V_{OUT} \leq 2.8V$	-	350	-	
			$2.8V < V_{OUT} \leq 4.5V$	-	250	-	
Line Regulation	ΔV_{LINE}	$I_O=1mA, V_{IN}=V_{OUT} +1V$ or 5V	-	1	5	mV	
Load Regulation (Note 2)	ΔV_{LOAD}	$I_O=0mA$ to 300mA	-	6	20	mV	
Ripple Rejection	PSRR	$V_{IN}=V_{OUT}+1V$ $C_{OUT}=1\mu F, f_{RIPPLE} = 120Hz$	-	60	-	dB	
Temperature Coefficient	TC	$I_{OUT} = 1mA, V_{IN} = 5V$	-	50	-	ppm/ °C	
Thermal Shutdown Temperature	TSD		-	160	-	°C	
Thermal Shutdown Hysteresis	ΔTSD		-	25	-	°C	

Note 1 : The dropout voltage is defined as $V_{IN}-V_{OUT}$, which is measured when V_{OUT} drop about 100mV.

Note 2 : Regulation is measured at a constant junction temperature by using 40ms current pulse and load regulation in the load range from 0mA to 300mA.



PIN DESCRIPTIONS

PIN SYMBOL	PIN DESCRIPTION
VIN	Power is supplied to this device from this pin which is required an input filter capacitor. In general, the input capacitor in the range of 1 μ F to 10 μ F is sufficient.
VOUT	The output supplies power to loads. The output capacitor is required to prevent output voltage from oscillation. The APE8800 is stable with an output capacitor 1 μ F or greater. The larger output capacitor will be required for application with larger load transients. The large output capacitor could reduce output noise, improve stability and PSRR.
GND	Common ground pin

BLOCK DIAGRAM

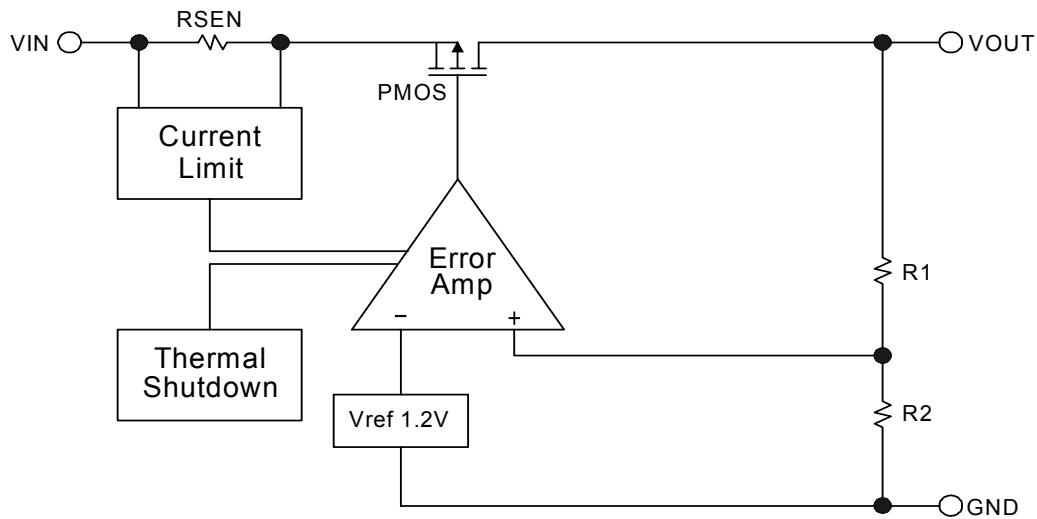

Figure 2. Block Diagram of APE8800



APPLICATION INFORMATION

The APE8800 series are low dropout linear regulators that could provide 300mA output current at dropout voltage about 300mV. Besides, current limit and on chip thermal shutdown features provide protection against any combination of overload or ambient temperature that could exceed junction temperature.

Output & Input Capacitor

The APE8800 regulator is designed to be stable with a wide range of output capacitors. The ESR of the output capacitor affects stability. Larger value of the output capacitor decreases the peak deviations and provides to improve transition response for larger current changes.

The capacitor types (aluminum, ceramic, and tant- alum) have different characterizations such as temperature and voltage coefficients. All ceramic capacitors are manufactured with a variety of dielectrics, each with different behavior across temperature and applications. Common dielectrics used are X5R, X7R and Y5V. It is recommended to use 1uF to 10uF X5R or X7R dielectric ceramic capacitors with 30mΩ to 50mΩ ESR range between device outputs to ground for transient stability. The APE8800 is designed to be stable with low ESR ceramic capacitors and higher values of capacitors and ESR could improve output stability. So the ESR of output capacitor is very important because it generates a zero to provide phase lead for loop stability.

There are no requirements for the ESR on the input capacitor, but its voltage and temperature coefficient have to be considered for device application environment

Protection Features

In order to prevent overloading or thermal condition from damaging the device, APE8800 regulator has internal thermal and current limiting functions designed to protect the device. It will rapidly shut off PMOS pass element during overloading or over temperature condition.

Thermal Consideration

The power handling capability of the device will be limited by maximum operation junction temperature (125°C). The power dissipated by the device will be estimated by $P_D = I_{OUT} \times (V_{IN} - V_{OUT})$. The power dissipation should be lower than the maximum power dissipation listed in "Absolute Maximum Ratings" section.



TYPICAL PERFORMANCE CHARACTERISTICS

Quiescent Current vs. Input Voltage

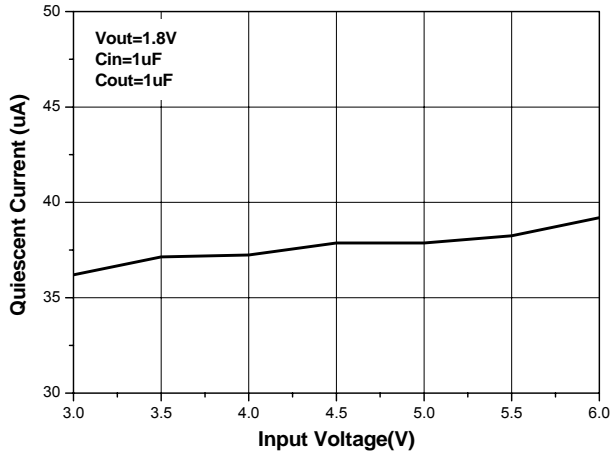

Quiescent Current vs. Input Voltage

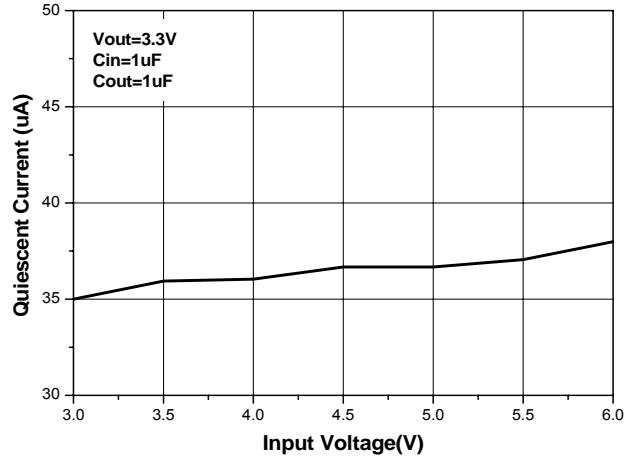

Current Limit vs. Input Voltage

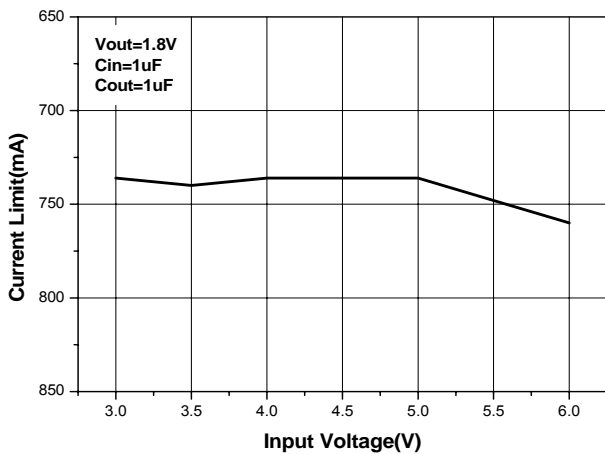

Current Limit vs. Input Voltage

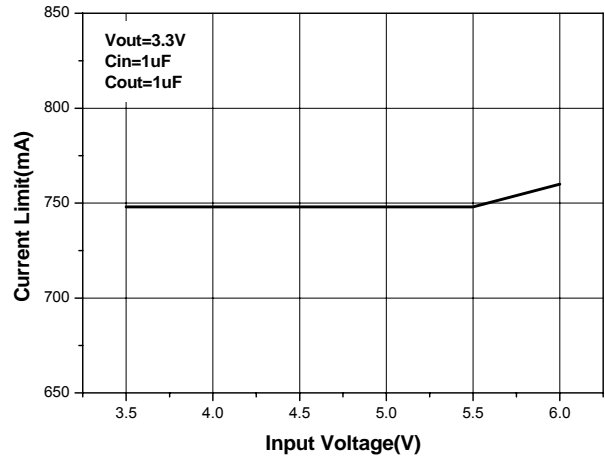

Current Limit vs. Temperature

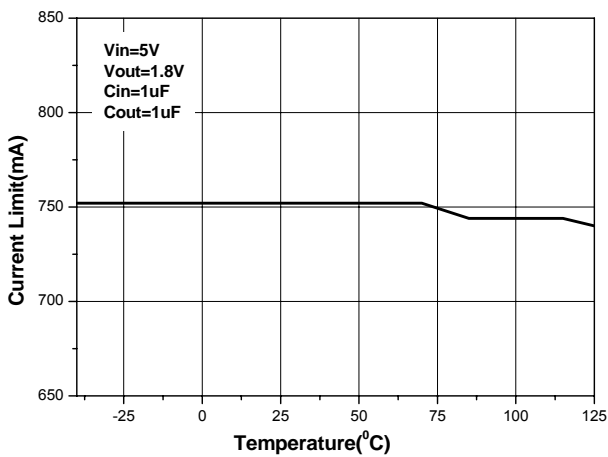

Current Limit vs. Temperature

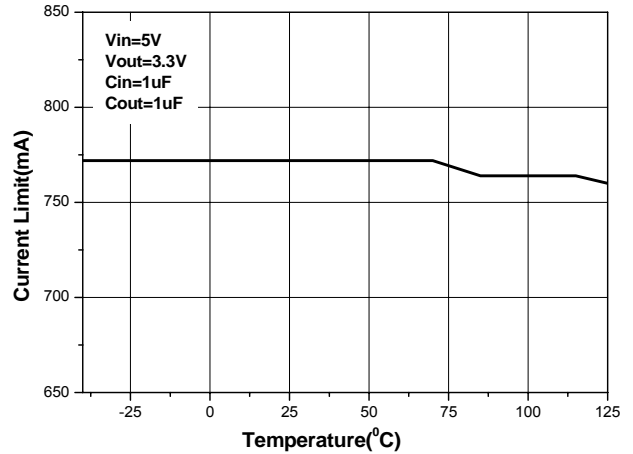



TYPICAL PERFORMANCE CHARACTERISTICS

Quiescent Current vs. Temperature

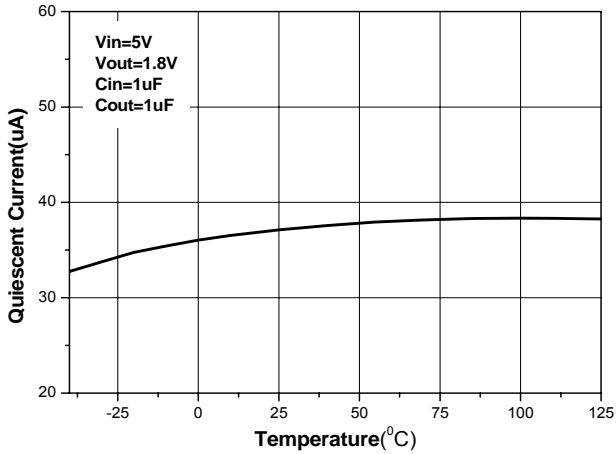

Quiescent Current vs. Temperature

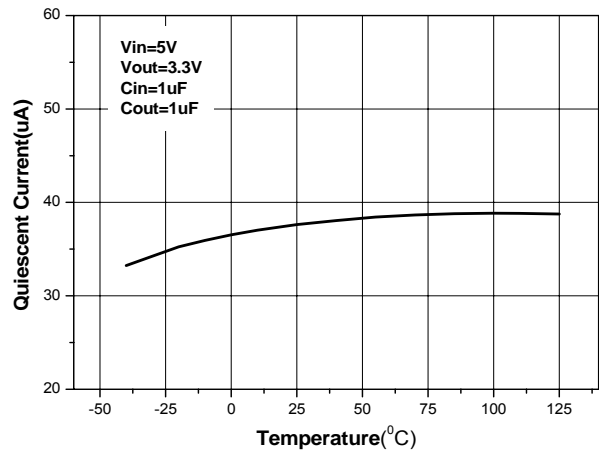

Temperature Stability

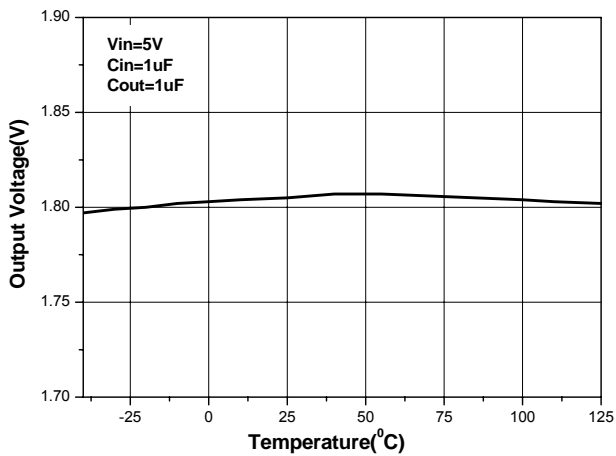

Temperature Stability

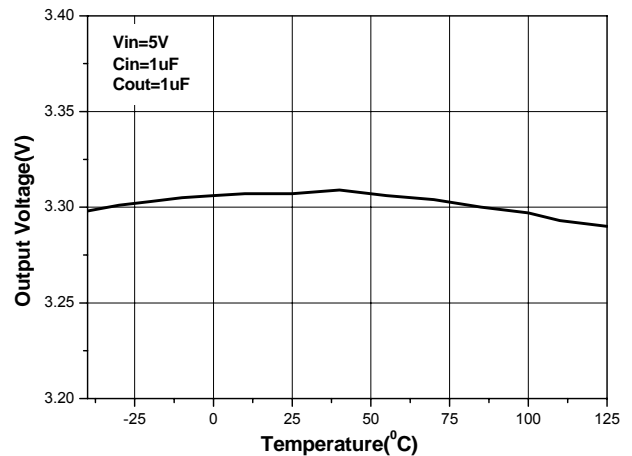

Dropout Voltage vs. Loading Current

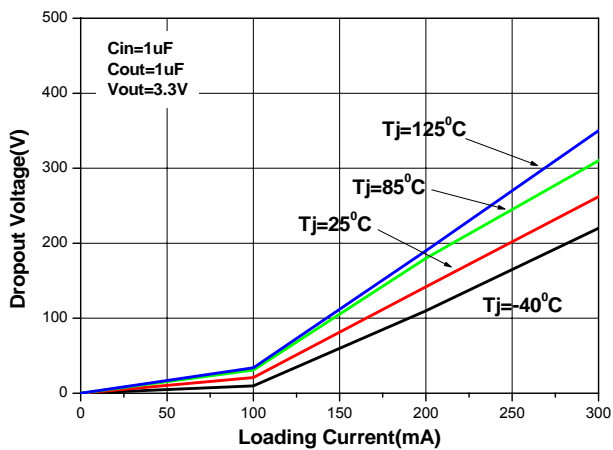



TYPICAL PERFORMANCE CHARACTERISTICS

Load Transient Response

($V_{IN}=4V$, $I_{OUT}=1mA$ to $150mA$, $V_{OUT}=3.3V$, $C_{IN}=1\mu F$, $C_{OUT}=1\mu F$)

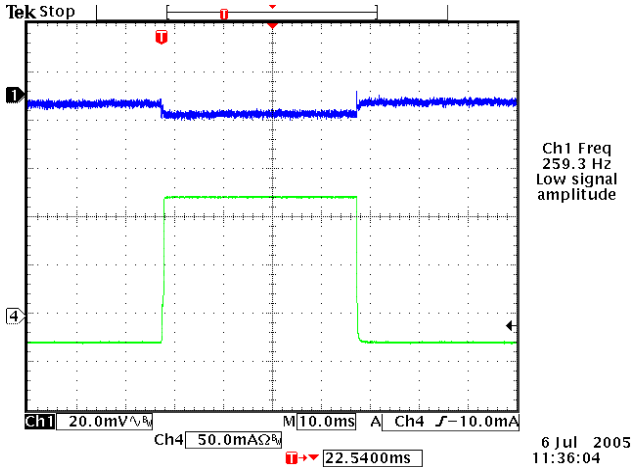

Load Transient Response

($V_{IN}=4V$, $I_{OUT}=1mA$ to $150mA$, $V_{OUT}=3.3V$, $C_{IN}=1\mu F$, $C_{OUT}=4.7\mu F$)

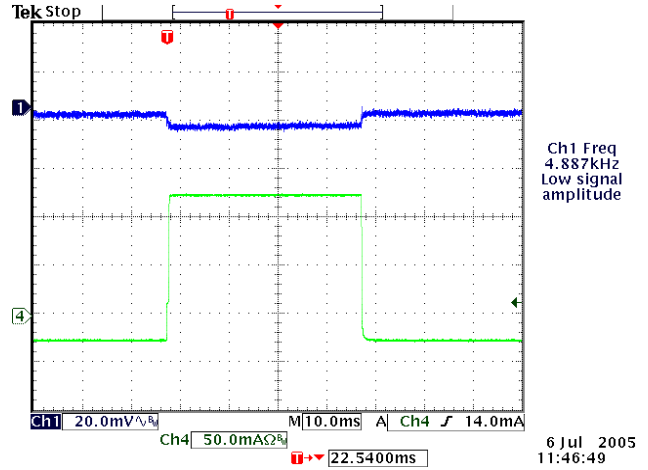

Line Transient Response

($V_{IN}=3V$ to $4V$, $I_{OUT}=10mA$, $V_{OUT}=1.8V$, $C_{IN}=1\mu F$, $C_{OUT}=1\mu F$)

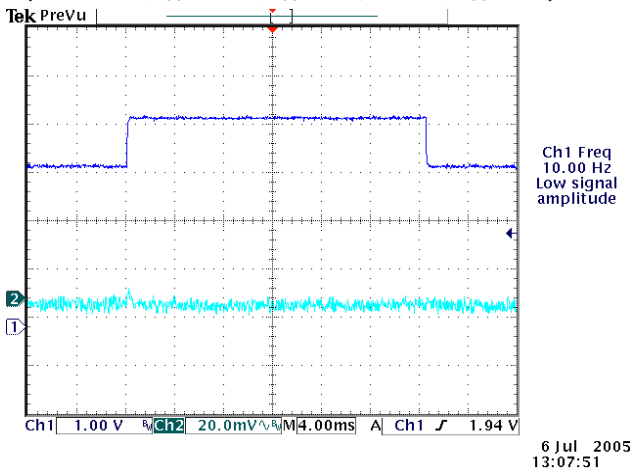

Line Transient Response

($V_{IN}=3V$ to $4V$, $I_{OUT}=10mA$, $V_{OUT}=1.8V$, $C_{IN}=1\mu F$, $C_{OUT}=4.7\mu F$)

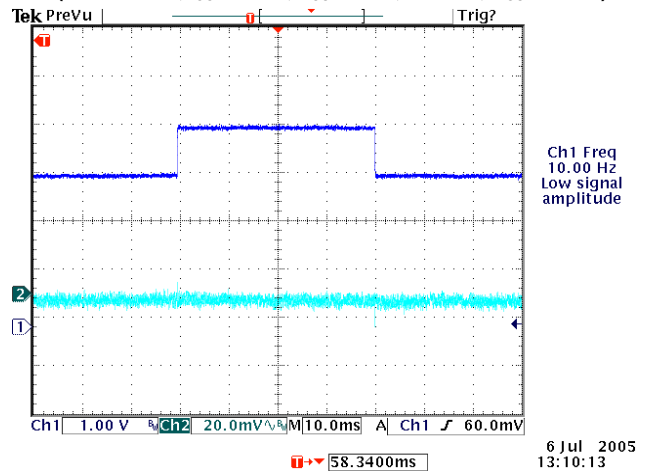



MARKING INFORMATION

SOT-23

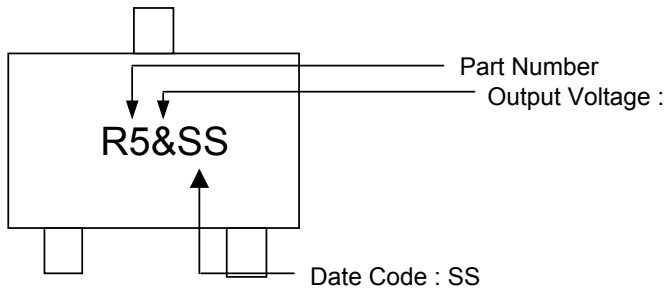

Output Voltage	VOUT Code
1.5V	A
1.8V	B
2.5V	C
2.8V	D
3.0V	E
3.3V	F
3.6V	H

SOT-89

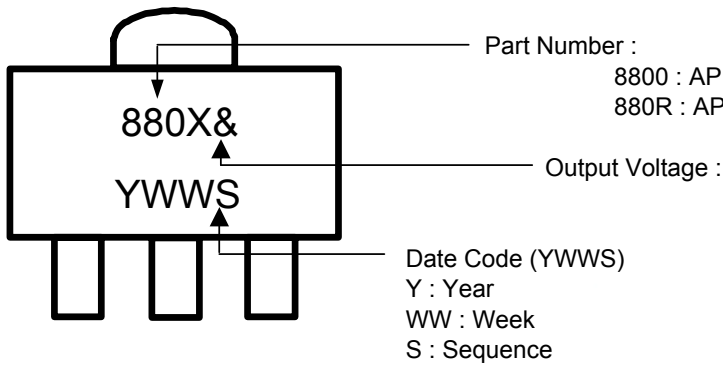

8800 : APE8800G
880R : APE8800GR

Output Voltage	VOUT Code
1.5V	A
1.8V	B
2.5V	C
2.8V	D
3.0V	E
3.3V	F
3.6V	H