

5A Low Dropout Fast Response Positive Adjustable Regulator and Fixed 3.3V

Features

- **Fast Transient Response**
- **Guaranteed Dropout Voltage at Multiple Currents**
- **Load Regulation: 0.05% Typ.**
- **Line Regulation: 0.03% Typ.**
- **Low Dropout Voltage: 1.3V Typ. at $I_{OUT} = 5A$**
- **Trimmed Current Limit: 5A Typ. at $T_j = 125^\circ C$**
- **On-Chip Thermal Limiting: 150°C Typ.**
- **Standard 3-pin TO-220, TO-252, and TO-263 Power Packages**
- **Lead Free and Green Devices Available (RoHS Compliant)**

Applications

- **Pentium™ Processor Supplies**
- **PowerPC™ Supplies**
- **Low Voltage Logic Supplies**
- **Battery-Powered Circuitry**
- **Post Regulator for Switching Power Supply**

General Description

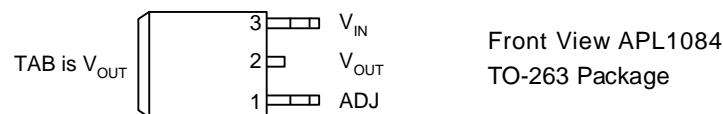

The APL1084 is a low dropout three-terminal adjustable regulator with 5A output current capability. In order to obtain lower dropout voltage and speed up transient response, which is critical for low voltage applications, the APL1084 has been optimized. The output available voltage range of adjustable version is from 1.25 to 5.75V with an input supply below 7V, and the fixed 3.3V output voltage device is also available. Current limit is trimmed to ensure specified output current and controlled short-circuit current. On-chip thermal limiting provides protection against any combination of overload that would create excessive junction temperatures. The APL1084 is available in both the through-hole and surface mount versions of the industry standard 3-pin TO-220, TO-252, and TO-263 power packages.

Pin Configuration

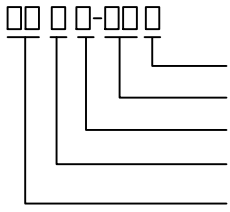

ANPEC reserves the right to make changes to improve reliability or manufacturability without notice, and advise customers to obtain the latest version of relevant information to verify before placing orders.

Ordering and Marking Information

APL1084		Assembly Material Handling Code Temperature Range Package Code Voltage Code	Package Code F : TO-220 G : TO-263-3 U : TO-252-3 Operating Ambient Temperature Range C : 0 to 70 °C Handling Code TR : Tape & Reel TU : Tube Voltage Code 33 : 3.3V Blank : Adjustable Version Assembly Material G : Halogen And Lead Free Device
APL1084 F/G/U:			XXXXX - Date Code
APL1084 33F/33G/33U :			XXXXX - Date Code

Note: ANPEC lead-free products contain molding compounds/die attach materials and 100% matte tin plate termination finish; which are fully compliant with RoHS. ANPEC lead-free products meet or exceed the lead-free requirements of IPC/JEDEC J-STD-020D for MSL classification at lead-free peak reflow temperature. ANPEC defines "Green" to mean lead-free (RoHS compliant) and halogen free (Br or Cl does not exceed 900ppm by weight in homogeneous material and total of Br and Cl does not exceed 1500ppm by weight).

Absolute Maximum Ratings (Note 1)

Symbol	Parameter	Rating	Unit
V_I	Input Voltage	7	V
T_J	Operating Junction Temperature Range	Control Section 0 to 125 Power Transistor 0 to 150	°C
T_{STG}	Storage Temperature Range	-65 to +150	°C
T_{SDR}	Maximum Lead Soldering Temperature, 10 Seconds	260	°C

Note 1 : Absolute Maximum Ratings are those values beyond which the life of a device may be impaired. Exposure to absolute maximum rating conditions for extended periods may affect device reliability.

Electrical Characteristics

Symbol	Parameter	Test Conditions	APL1084			Unit
			Min.	Typ.	Max.	
V_{REF}	Reference Voltage APL1084	$1.5V \leq (V_{IN} - V_{OUT}) \leq 5.75V$, $10mA \leq I_{OUT} \leq 5A$, $T_J = 0 \sim 125^\circ C$	1.225 (-2%)	1.250	1.275 (+2%)	V
V_{OUT}	Output Voltage APL1084-3.3	$10mA \leq I_{OUT} \leq 5A$, $4.75V \leq V_{IN} \leq 7V$, $T_J = 0 \sim 125^\circ C$	3.235 (-2%)	3.300	3.365 (+2%)	V
REG_{LINE}	Line Regulation APL1084 APL1084-3.3	$T_J = 0 \sim 125^\circ C$, (Note 2) $2.75V \leq V_{IN} \leq 7V$, $I_{OUT} = 10mA$, $4.75V \leq V_{IN} \leq 7V$, $I_{OUT} = 0mA$,	-	0.03	0.2	%
REG_{LOAD}	Load Regulation APL1084 APL1084-3.3	$T_J = 25^\circ C$, (Note 2) $(V_{IN} - V_{OUT}) = 3V$, $10mA \leq I_{OUT} \leq 5A$ $V_{IN} = 5V$, $0mA \leq I_{OUT} \leq 5A$	-	0.05 0.05	0.3 0.5	%
V_D	Dropout Voltage	$\Delta V_{REF} = 1\%$, $I_{OUT} = 3A$, $T_J = 0 \sim 125^\circ C$	-	1.2	1.4	V
		$\Delta V_{REF} = 1\%$, $I_{OUT} = 5A$, $T_J = 0 \sim 125^\circ C$	-	1.3	1.5	

Electrical Characteristics (Cont.)

Symbol	Parameter	Test Conditions	APL1084			Unit
			Min.	Typ.	Max.	
I _{LIMIT}	Current Limit	(V _{IN} -V _{OUT})=1.7V, T _J =25°C T _J =125°C	6.0 5.0	7.6 6.0	-	A
		(V _{IN} -V _{OUT})=3V, T _J =25°C T _J =125°C	6.5 5.5	8.2 6.5	-	
I _{ADJ}	Adjust Pin Current APL1084	(V _{IN} -V _{OUT})=3V, I _{OUT} =10mA, T _J =0~125°C	-	60	120	μA
ΔI _{ADJ}	Adjust Pin Current Change APL1084	1.5V≤(V _{IN} -V _{OUT})≤5.75V, 10mA≤I _{OUT} ≤5A	-	0.2	5	μA
I _{LMIN}	Minimum Load Current APL1084	1.5V≤(V _{IN} -V _{OUT})≤5.75V, T _J =0~125°C	-	2	10	mA
I _Q	Quiescent Current APL1084-3.3	V _{IN} =5V	-	8	13	mA
PSRR	Ripple Rejection APL1084 APL1084-3.3	F=120Hz, C _{OUT} =22μF, Tant., (V _{IN} -V _{OUT})=3V, I _{OUT} =5A	60	-	-	dB
		F=120Hz, C _{OUT} =22μF, Tant., (V _{IN} =6.3V, I _{OUT} =5A				
L _S	Long -Term Stability	T _J =125°C, 1000Hrs.	-	0.03	1.0	%
V _N	RMS Output Noise (% of V _{OUT})	T _J =25°C, 10Hz≤F≤10kHz	-	0.003	-	%
θ _{th,J-TAB}	Thermal Resistance Junction-to-Case, at TAB	(Note 3)	-	6.0	-	°C/ W
θ _{th,J-AMB}	Thermal Resistance Junction-to-Ambient	TO-263	-	50	-	°C/ W
		TO-252				

Note 2: See thermal regulation specifications for changes in output voltage due to heating effects. Load and line regulations are measured at a constant junction temperature by low duty cycle pulse testing.

Note 3 :The value could be varied when heat sink size is different. Use larger heat sink or larger PCB size, which improves θ_{th,TAB-A} to improve overall thermal resistance (θ_{th,J-A}).

Typical Operating Characteristics

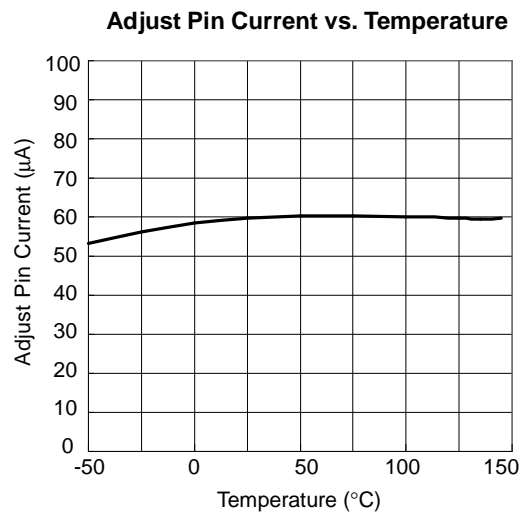
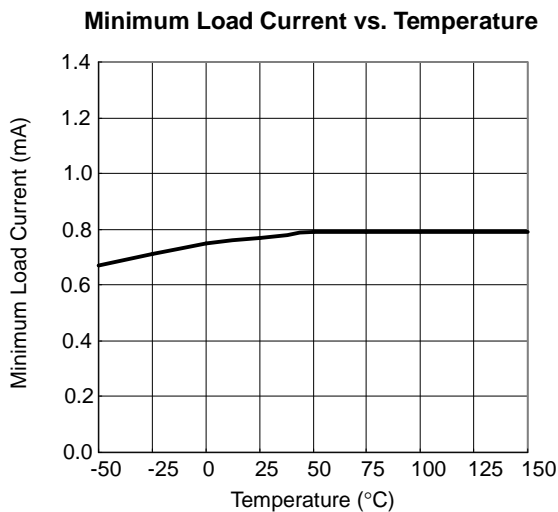
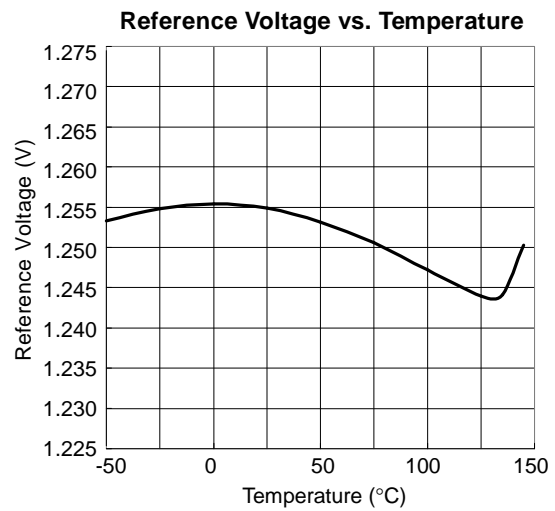
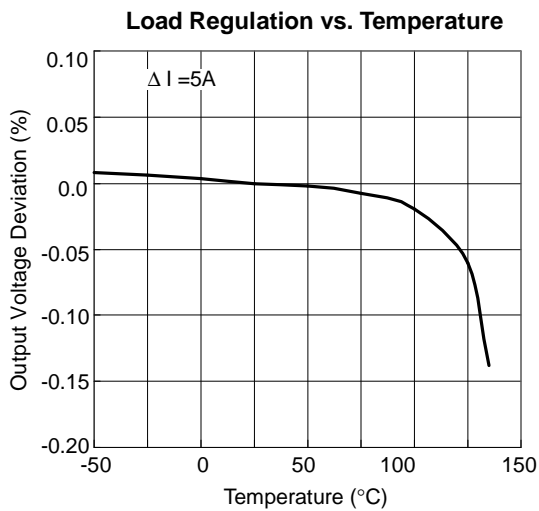
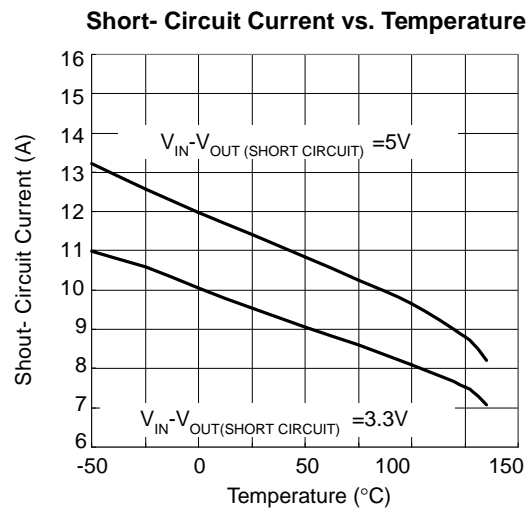
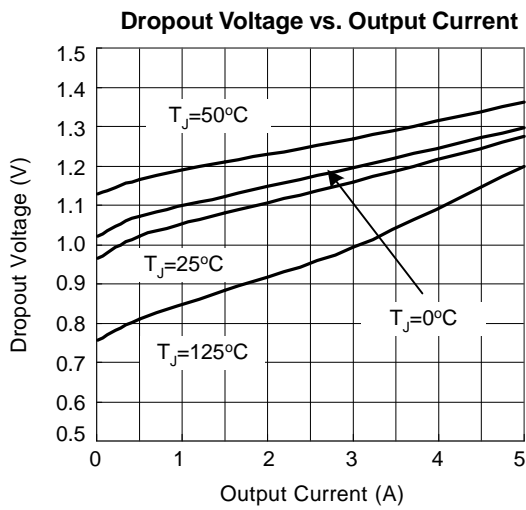

Typical Operating Characteristics (Cont.)

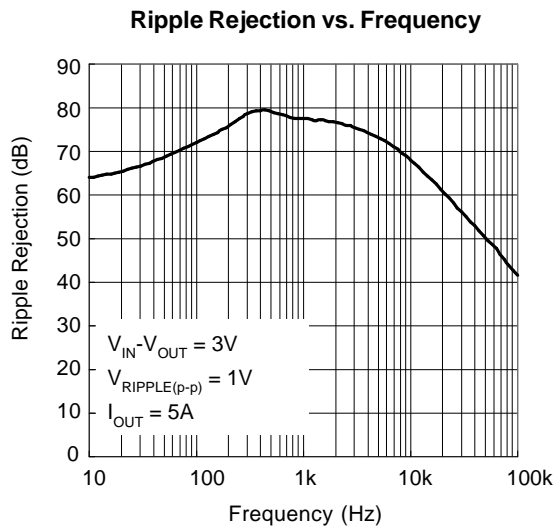

Typical Application Circuits

Typical Regulator

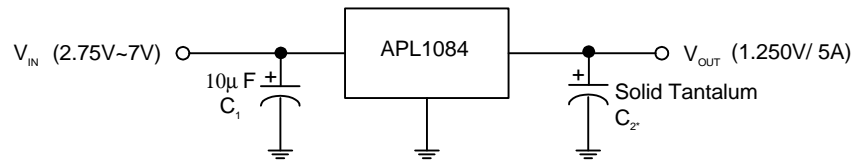

5V to 3.3V Regulator

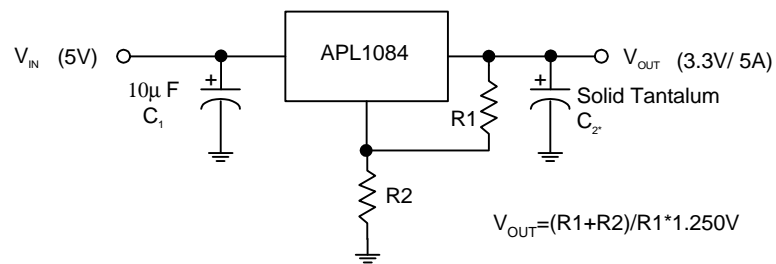

* Required for stability

APL1084: $C_2 = 10\mu F$

* R1 is typically in range of 100Ω to 120Ω

Package Information

TO-220

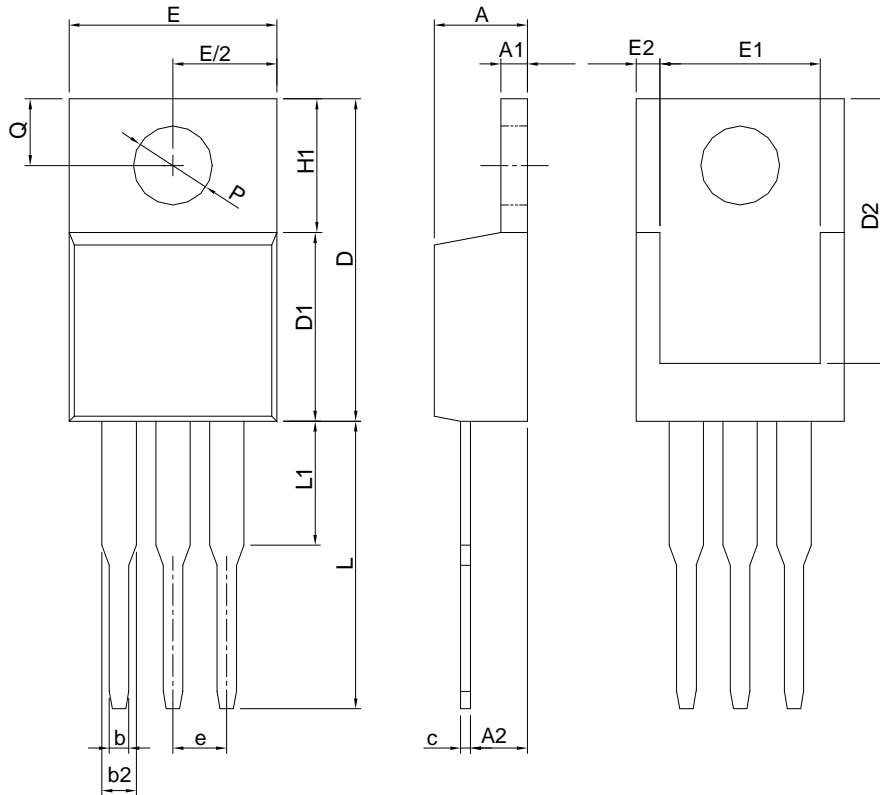

SYMBOL	TO-220			
	MILLIMETERS		INCHES	
	MIN.	MAX.	MIN.	MAX.
A	3.56	4.83	0.140	0.190
A1	0.51	1.40	0.020	0.055
A2	2.03	2.92	0.080	0.115
b	0.38	1.02	0.015	0.040
b2	1.14	1.78	0.045	0.070
c	0.36	0.61	0.014	0.024
D	14.22	16.51	0.560	0.650
D1	8.38	9.02	0.330	0.355
D2	12.19	12.88	0.480	0.507
E	9.65	10.67	0.380	0.420
E1	6.86	8.89	0.270	0.350
E2		0.76		0.030
e	2.54 BSC		0.100 BSC	
H1	5.84	6.86	0.230	0.270
L	12.70	14.73	0.500	0.580
L1		6.35		0.250
P	3.53	4.09	0.139	0.161
Q	2.54	3.43	0.100	0.135

Note: Follow JEDEC TO-220 AB.

Package Information

TO-252-3 (Package 1)

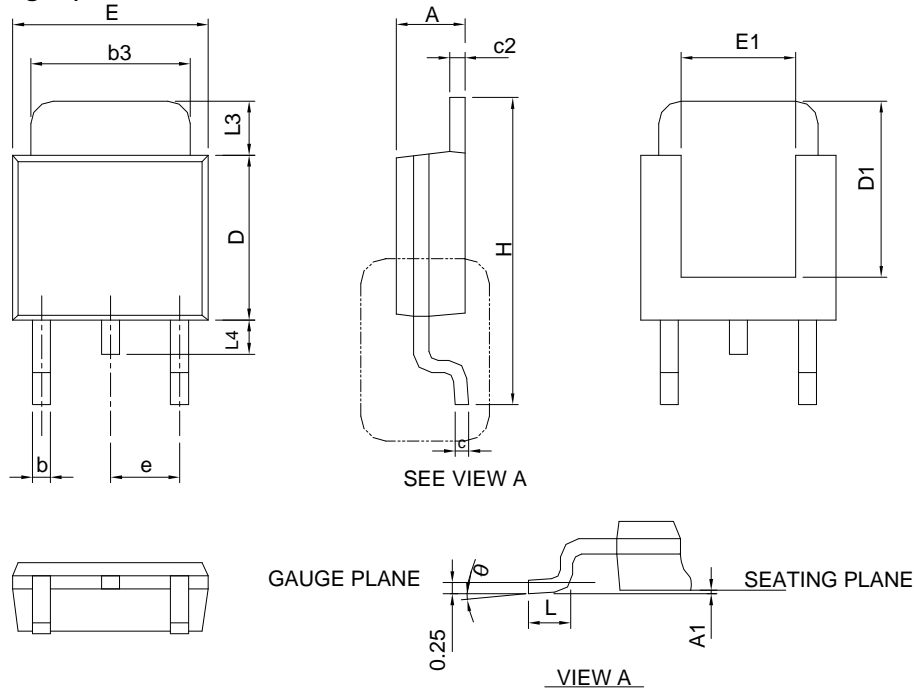

SYMBOL	TO-252-3			
	MILLIMETERS		INCHES	
	MIN.	MAX.	MIN.	MAX.
A	2.18	2.39	0.086	0.094
A1		0.13		0.005
b	0.50	0.89	0.020	0.035
b3	4.95	5.46	0.195	0.215
c	0.46	0.61	0.018	0.024
c2	0.46	0.89	0.018	0.035
D	5.33	6.22	0.210	0.245
D1	4.57	6.00	0.180	0.236
E	6.35	6.73	0.250	0.265
E1	3.81	6.00	0.150	0.236
e	2.29 BSC		0.090 BSC	
H	9.40	10.41	0.370	0.410
L	0.90	1.78	0.035	0.070
L3	0.89	2.03	0.035	0.080
L4		1.02		0.040
θ	0°	8°	0°	8°

Note : Follow JEDEC TO-252 .

Package Information

TO-252-3 (Package 2)

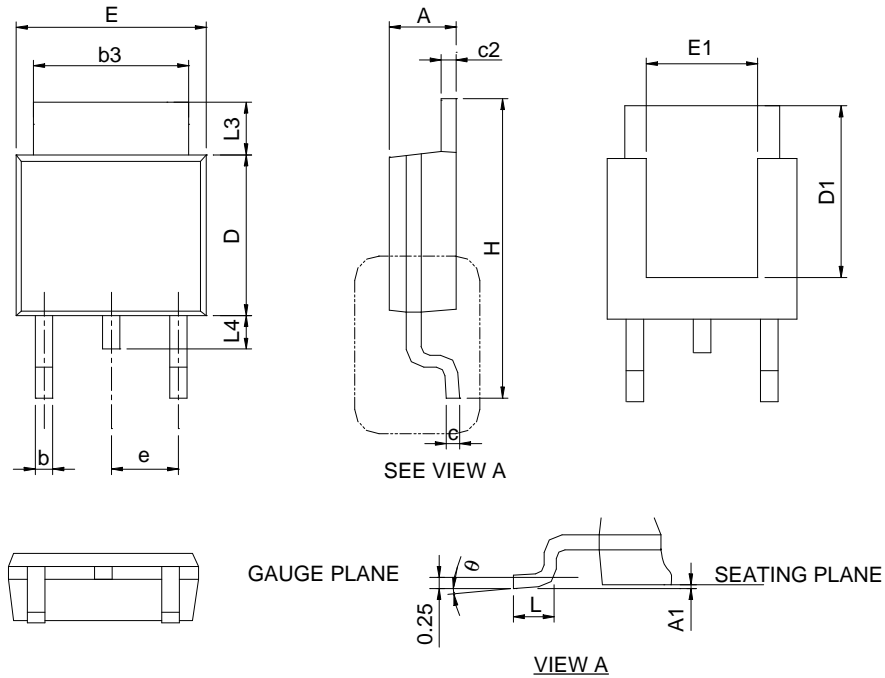

Symbol	TO-252-3			
	MILLIMETERS		INCHES	
	MIN.	MAX.	MIN.	MAX.
A	2.18	2.39	0.086	0.094
A1		0.13		0.005
b	0.50	0.89	0.020	0.035
b3	4.95	5.46	0.195	0.215
c	0.46	0.61	0.018	0.024
c2	0.46	0.89	0.018	0.035
D	5.33	6.22	0.210	0.245
D1	4.57	6.00	0.180	0.236
E	6.35	6.73	0.250	0.265
E1	3.81	6.00	0.150	0.236
e	2.29 BSC		0.090 BSC	
H	9.40	10.41	0.370	0.410
L	0.90	1.78	0.035	0.070
L3	0.89	2.03	0.035	0.080
L4		1.02		0.040
θ	0°	8°	0°	8°

Note : 1. Followed from JEDEC TO-252 .

Package Information

TO-263-3

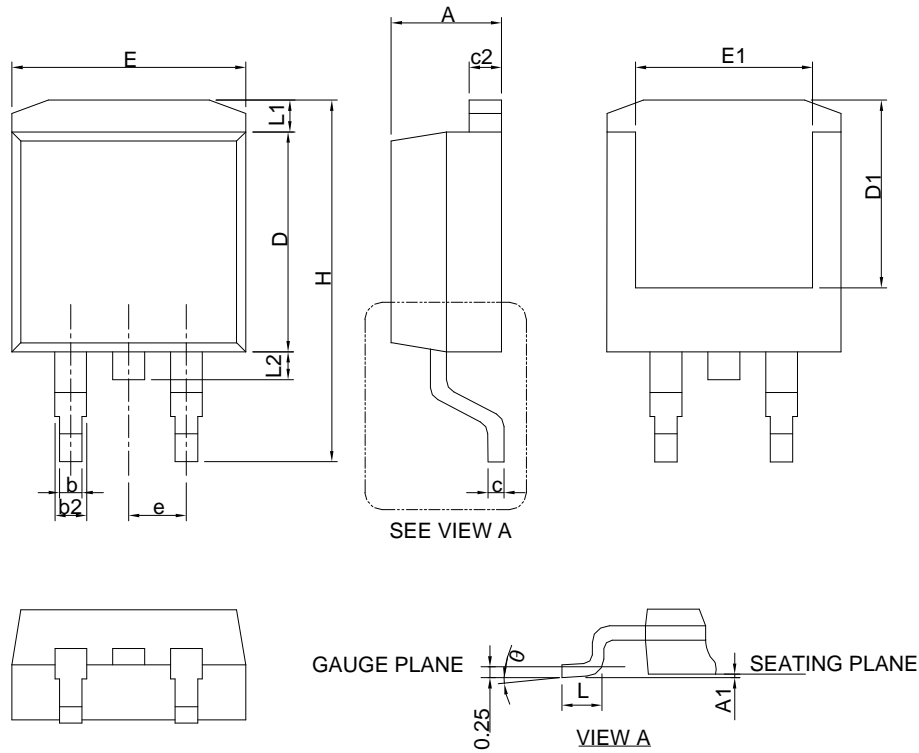

DIMENSIONS	TO-263-3			
	MILLIMETERS		INCHES	
	MIN.	MAX.	MIN.	MAX.
A	4.06	4.83	0.160	0.190
A1	0.00	0.25	0.000	0.010
b	0.51	0.99	0.020	0.039
b2	1.14	1.78	0.045	0.070
c	0.38	0.74	0.015	0.029
c2	1.14	1.65	0.045	0.065
D	8.38	9.65	0.330	0.380
D1	6.00	9.00	0.236	0.354
E	9.65	11.43	0.380	0.450
E1	6.22	9.00	0.245	0.354
e	2.54 BSC		0.100 BSC	
H	14.61	15.88	0.575	0.625
L	1.78	2.79	0.070	0.110
L1		1.68		0.066
L2		1.78		0.070
θ	0°	8°	0°	8°

Note : Follow JEDEC TO-263 AB.

Carrier Tape & Reel Dimensions

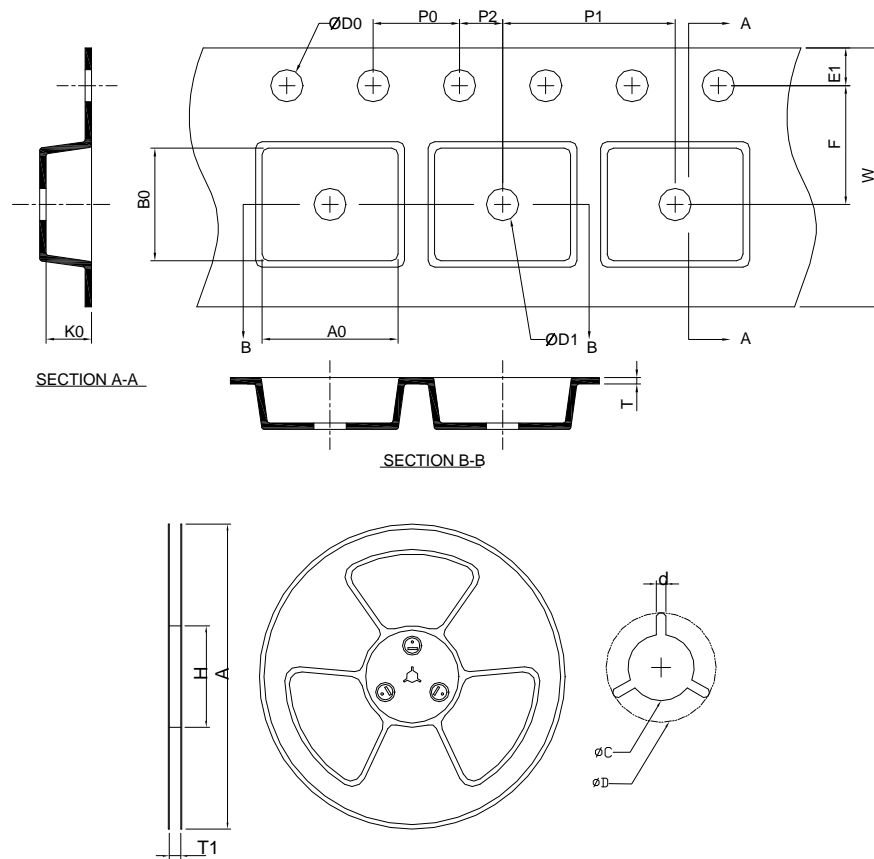

Application	A	H	T1	C	d	D	W	E1	F
TO-252-3	330.0 ±0.00	50 MIN.	16.4+2.00 -0.00	13.0+0.50 -0.20	1.5 MIN.	20.2 MIN.	16.0 ±0.30	1.75 ±0.10	7.50 ±0.05
	P0	P1	P2	D0	D1	T	A0	B0	K0
	4.0 ±0.10	8.0 ±0.10	2.0 ±0.05	1.5+0.10 -0.00	1.5 MIN.	0.6+0.00 -0.40	6.80 ±0.20	10.40 ±0.20	2.50 ±0.20
Application	A	H	T1	C	d	D	W	E1	F
TO-263-3	330.0 ±0.00	50 MIN.	24.4+2.00 -0.00	13.0+0.50 -0.20	1.5 MIN.	20.2 MIN.	24.0 ±0.30	1.75 ±0.10	11.5 ±0.10
	P0	P1	P2	D0	D1	T	A0	B0	K0
	4.0 ±0.10	16.0 ±0.10	2.0 ±0.10	1.5+0.10 -0.00	1.5 MIN.	0.6+0.00 -0.40	10.8 ±0.20	16.1 ±0.20	5.2 ±0.20

(mm)

Devices Per Unit

Package Type	Unit	Quantity
TO-252-3	Tape & Reel	2500
TO-263-3	Tape & Reel	800

Taping Direction Information

TO-252-3

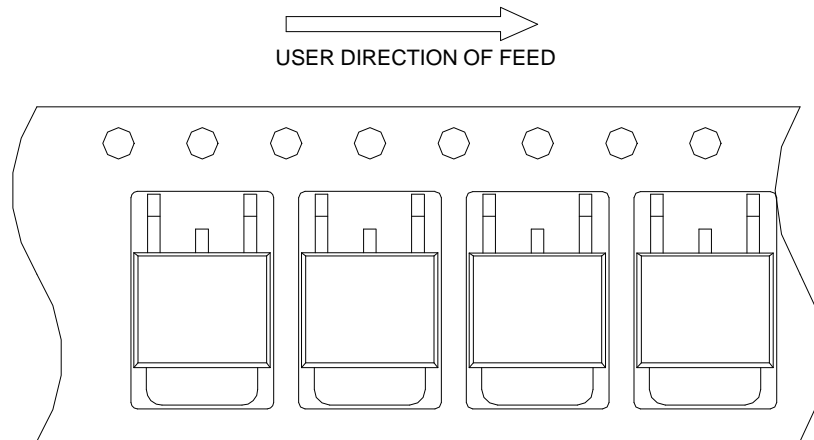

TO-263-3

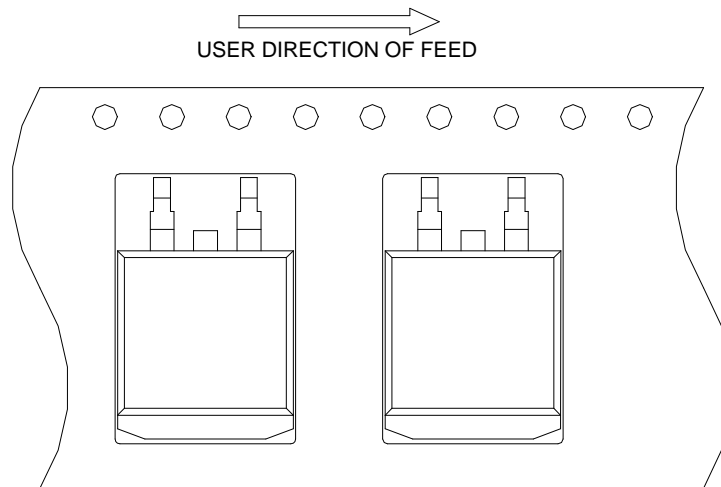

Classification Profile

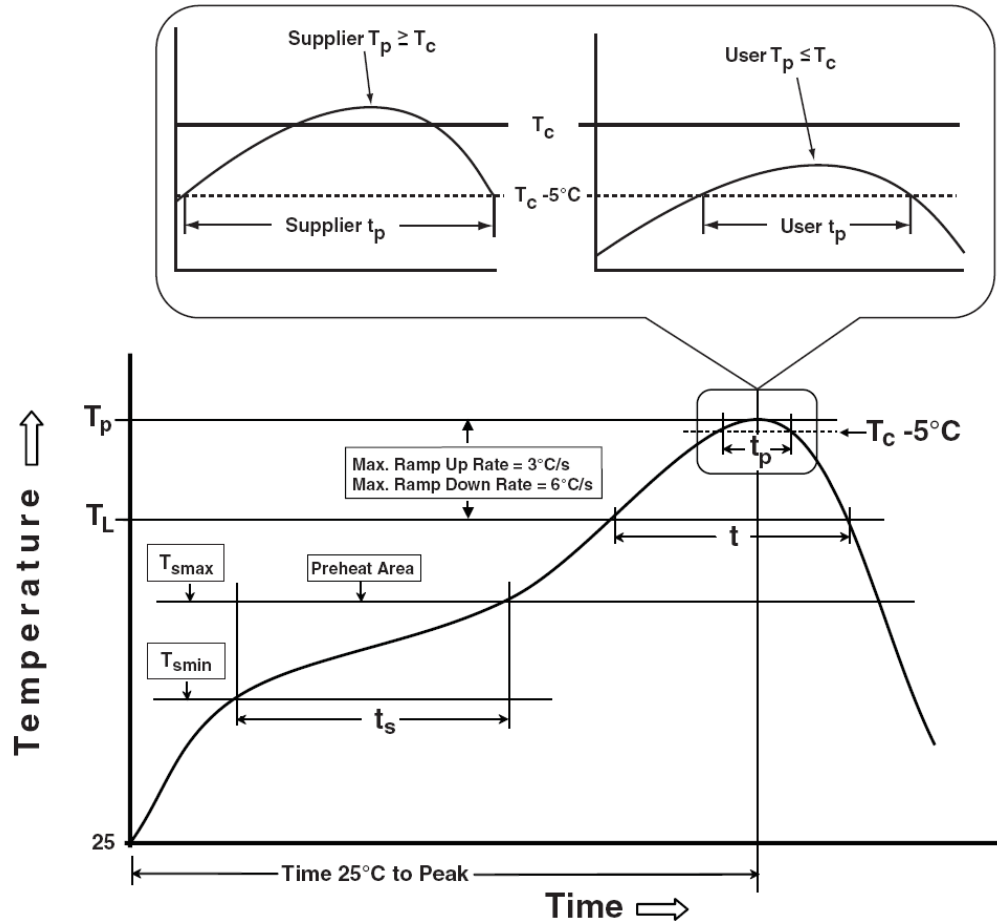

Classification Reflow Profiles

Profile Feature	Sn-Pb Eutectic Assembly	Pb-Free Assembly
Preheat & Soak		
Temperature min (T_{smin})	100 °C	150 °C
Temperature max (T_{smax})	150 °C	200 °C
Time (T_{smin} to T_{smax}) (t_s)	60-120 seconds	60-120 seconds
Average ramp-up rate (T_{smax} to T_p)	3 °C/second max.	3°C/second max.
Liquidous temperature (T_L)	183 °C	217 °C
Time at liquidous (t_L)	60-150 seconds	60-150 seconds
Peak package body Temperature (T_p)*	See Classification Temp in table 1	See Classification Temp in table 2
Time (t_p)** within 5°C of the specified classification temperature (T_c)	20** seconds	30** seconds
Average ramp-down rate (T_p to T_{smax})	6 °C/second max.	6 °C/second max.
Time 25°C to peak temperature	6 minutes max.	8 minutes max.
* Tolerance for peak profile Temperature (T_p) is defined as a supplier minimum and a user maximum.		
** Tolerance for time at peak profile temperature (t_p) is defined as a supplier minimum and a user maximum.		

Classification Reflow Profiles (Cont.)

Table 1. SnPb Eutectic Process – Classification Temperatures (Tc)

Package Thickness	Volume mm ³	
	<350	≥350
<2.5 mm	235 °C	220 °C
≥2.5 mm	220 °C	220 °C

Table 2. Pb-free Process – Classification Temperatures (Tc)

Package Thickness	Volume mm ³		
	<350	350-2000	>2000
<1.6 mm	260 °C	260 °C	260 °C
1.6 mm – 2.5 mm	260 °C	250 °C	245 °C
≥2.5 mm	250 °C	245 °C	245 °C

Reliability Test Program

Test item	Method	Description
SOLDERABILITY	JESD-22, B102	5 Sec, 245°C
HOLT	JESD-22, A108	1000 Hrs, Bias @ T _f =125°C
PCT	JESD-22, A102	168 Hrs, 100%RH, 2atm, 121°C
TCT	JESD-22, A104	500 Cycles, -65°C~150°C
HBM	MIL-STD-883-3015.7	VHBM 2KV
MM	JESD-22, A115	VMM 200V
Latch-Up	JESD 78	10ms, 1 _{tr} 100mA

Customer Service

Anpec Electronics Corp.

Head Office :

No.6, Dusing 1st Road, SBIP,
Hsin-Chu, Taiwan, R.O.C.
Tel : 886-3-5642000
Fax : 886-3-5642050

Taipei Branch :

2F, No. 11, Lane 218, Sec 2 Jhongsing Rd.,
Sindian City, Taipei County 23146, Taiwan
Tel : 886-2-2910-3838
Fax : 886-2-2917-3838