

## Low $I_Q$ , Low Dropout 900mA Fixed Voltage Regulator

### Features

- **Low Noise** :  $50\text{mV}_{\text{RMS}}$  (100Hz to 100kHz)
- **Low Quiescent Current** :  $50\text{mA}$  (No load)
- **Low Dropout Voltage** :  $210\text{mV}$  (@900mA)
- **Very Low Shutdown Current** :  $< 1\text{mA}$
- **Fixed Output Voltage** :  $1.3\text{V} \sim 3.4\text{V}$
- **Stable with  $4.7\text{mF}$  Output Capacitor**
- **Stable with Aluminum , Tantalum, or Ceramic Capacitors**
- **Reverse Current Protection**
- **No Protection Diodes Needed**
- **Built-in Thermal Protection**
- **Built-in Current Limit Protection**
- **Controlled Short Circuit Current** :  $200\text{mA}$
- **Fast Transient Response**
- **Short Setting Time**
- **SOT-89, SOT-89-5, SOT-223, SOP-8 ,TO-252, and TO-252-5 Packages**
- **Lead Free and Green Devices Available (RoHS Compliant)**

### Pin Configuration

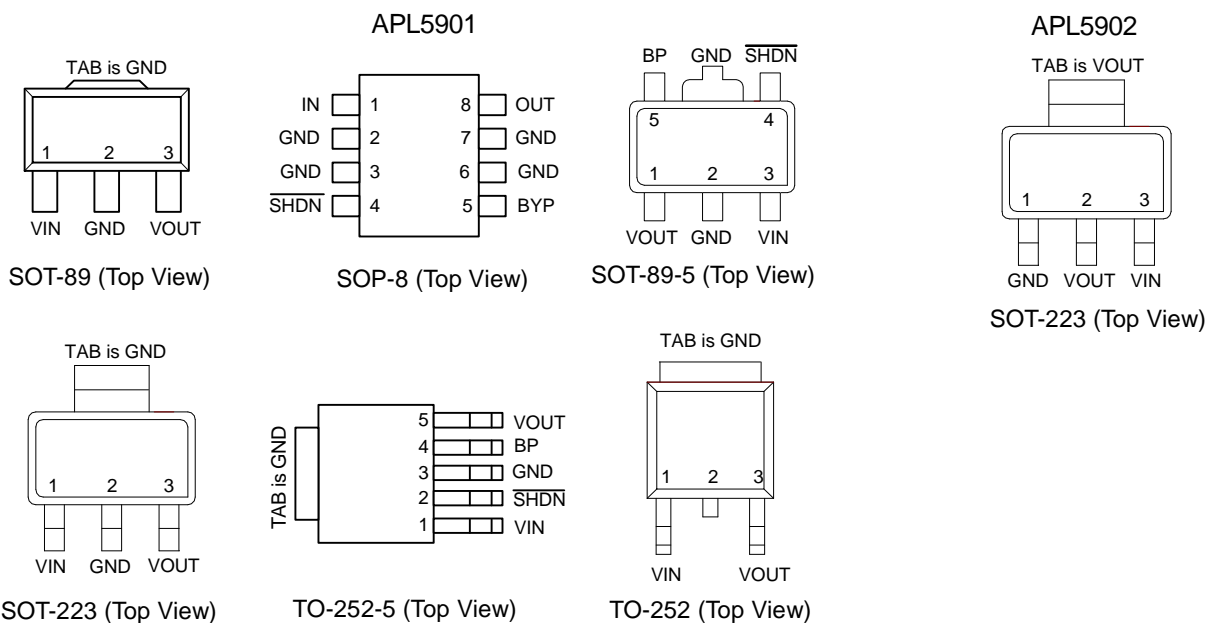

### General Description

The APL5901/2 is a micropower, low noise, and low dropout linear regulator. Operate from 2.7V to 6V input voltage and deliver up to 900mA. Typical output noise is just  $50\mu\text{V}_{\text{RMS}}$  with the addition of an external  $0.1\mu\text{F}$  bypass capacitor in the BP pin and the typical dropout voltage is only 210mV at 900mA loading. Designed for use in battery-powered system, the low  $50\mu\text{A}$  quiescent current makes it an ideal choice.



Design with an internal P-channel MOSFET pass transistor, the APL5901/2 maintain a low supply current, independent of the load current and dropout voltage. Other features including reverse current protection, thermal-shutdown protection, and current-limit protection ensure specified output current and controlled short-circuit current. The APL5901/2 regulator come in a miniature SOT-89, SOT-89-5, SOT-223, SOP-8, TO-252, and TO-252-5 packages.

### Applications

- **Notebook Computer**
- **PDA or Portable Equipments**
- **Noise-Sensitive Instrumentation Systems**

ANPEC reserves the right to make changes to improve reliability or manufacturability without notice, and advise customers to obtain the latest version of relevant information to verify before placing orders.

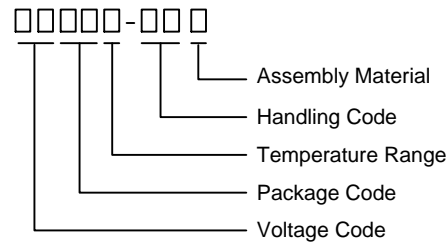
## Ordering and Marking Information

<p>APL5901/2    □□□□□-□□□</p>  <p>Assembly Material Handling Code Temperature Range Package Code Voltage Code</p>	<p>Package Code D : SOT-89                      D5 : SOT-89-5                      U : TO-252 U5 : TO-252-5                      V : SOT-223                      K : SOP-8 Operating Ambient Temperature Range C : 0 to 70 °C Handling Code TR : Tape &amp; Reel Voltage Code 13 : 1.3V ~ 34 : 3.4V Assembly Material L : Lead Free Device    G : Halogen and Lead Free Device</p>
<p>APL5901/2    13 D/V/K :    <span style="border: 1px solid black; padding: 2px;">APL5901/2 XXXXX13</span></p>	<p>XXXXX - Date Code , 13 - 1.3V</p>
<p>APL5901/2    13 U :    <span style="border: 1px solid black; padding: 2px;"> 13 APL5901/2 XXXXX</span></p>	<p>XXXXX - Date Code , 13 - 1.3V</p>

Note: ANPEC lead-free products contain molding compounds/die attach materials and 100% matte tin plate termination finish; which are fully compliant with RoHS. ANPEC lead-free products meet or exceed the lead-free requirements of IPC/JEDEC J-STD-020C for MSL classification at lead-free peak reflow temperature. ANPEC defines "Green" to mean lead-free (RoHS compliant) and halogen free (Br or Cl does not exceed 900ppm by weight in homogeneous material and total of Br and Cl does not exceed 1500ppm by weight).

## Absolute Maximum Ratings (Note 1)

Symbol	Parameter	Rating	Unit
$V_{IN}, V_{OUT}$	Input Voltage or Out Voltage	6.5	V
$\overline{SHDN}$	Shutdown Control Pin	6.5	V
$P_D$	Power Dissipation	Internally Limited	W
$T_{STG}$	Storage Temperature Range	-65 to +150	°C
$T_L$	Lead Temperature, 10 Seconds	260	°C

Note 1 : Stresses beyond the absolute maximum rating may damage the device and exposure to absolute maximum rating conditions for extended periods may affect device reliability.

## Thermal Characteristics

Symbol	Parameter	Typical Value	Unit
$R_{TH,JA}$	Thermal Resistance – Junction to Ambient	SOT-89	180
		SOT-223	135
		SOP-8	150
		TO-252	50
$R_{TH,JC}$	Thermal Resistance – Junction to Case	SOT-89	38
		SOT-223	15
		SOP-8	20
		TO-252	6
$T_J$	Operating Junction Temperature	Control Section	0 to 125
		Power Transistor	0 to 150

### Electrical Characteristics

Unless otherwise noted these specifications apply over full temperature,  $V_{IN}=3.6V$ ,  $C_{IN}=1\mu F$ ,  $C_{OUT}=4.7\mu F$ ,  $\overline{SHDN}=V_{IN}$ ,  $T_J=0$  to  $125^\circ C$ . Typical values refer to  $T_J=25^\circ C$ .

Symbol	Parameter	Test Conditions	APL5901/2			Unit	
			Min.	Typ.	Max.		
$V_{IN}$	Input Voltage		2.7	-	6	V	
$V_{OUT}$	Output Voltage	$V_{OUT}+1.0V < V_{CC} < 6.0V$ , $0mA < I_{OUT} < I_{MAX}$	$V_{OUT}-2\%$	$V_{OUT}$	$V_{OUT}+2\%$	V	
$I_{LIMIT}$	Circuit Current Limit	$V_{IN}=4.3V$	-	1.5	-	A	
$I_{SHORT}$	Short Current	$V_{OUT}=0V$	-	200	-	mA	
$I_{OUT}$	Load Current		900	-	-	mA	
REG <sub>LINE</sub>	Line Regulation	$V_{OUT}+0.5V < V_{CC} < 6.0V$ , $I = 1mA$	-	4	10	mV	
REG <sub>LOAD</sub>	Load Regulation	$V_{IN} = V_{OUT}+1.0V$ , $0mA < I_{OUT} < I_{MAX}$	-	1	6	mV	
$V_{DROP}$	Dropout Voltage <sup>(Note2)</sup>	$I_{OUT} = 900mA$	$1.3V \leq V_{OUT} < 1.5V$	-	1100	1300	mV
			$1.5V \leq V_{OUT} < 2V$	-	900	1050	
			$2V \leq V_{OUT} < 2.5V$	-	500	700	
			$2.5V \leq V_{OUT} < 3.4V$	-	280	380	
PSRR	Ripple Rejection	$F \leq 1kHz$ , $1V_{pp}$ at $V_{IN} = V_{OUT}+1.0V$	55	65	-	dB	
$I_Q$	Quiescent Current	No load	-	50	100	$\mu A$	
		$I_{OUT}=900mA$	-	370	450		
	Shutdown Supply Current <sup>(Note3)</sup>	Shutdown = low $I_{OUT}=0$ , $V_{CC} = 6.0V$	-	0.01	1	$\mu A$	
	Noise <sup>(Note3)</sup>	$100Hz < f < 100kHz$ , typical load, $C_{BP}=0.01\mu F$ , $C_{OUT} = 1\mu F$	-	50	-	$\mu V_{rms}$	
		$100Hz < f < 100kHz$ , typical load, $C_{BP}=0.1\mu F$ , $C_{OUT} = 1\mu F$	-	40	-		
	Shutdown Recovery Delay <sup>(Note3)</sup>	$C_{BP}=0.01\mu F, C_{OUT}=1\mu F$ , no load	-	7	-	ms	
	$C_{BP}=0.1\mu F, C_{OUT}=1\mu F$ , no load	-	70	-			
OTS	Over-Temperature Shutdown		-	150	-	$^\circ C$	
	Over-Temperature Shutdown Hysteresis	Hysteresis	-	10	-	$^\circ C$	
TC	Output-Voltage Temperature Coefficient		-	50	-	ppm/ $^\circ C$	

## Electrical Characteristics (Cont.)

Unless otherwise noted these specifications apply over full temperature,  $V_{IN}=3.6V$ ,  $C_{IN}=1\mu F$ ,  $C_{OUT}=4.7\mu F$ ,  $\overline{SHDN}=V_{IN}$ ,  $T_J=0$  to  $125^\circ C$ . Typical values refer to  $T_J=25^\circ C$ .

Symbol	Parameter	Test Conditions	APL5901/2			Unit
			Min.	Typ.	Max.	
$C_{OUT}$	Output Capacitor		4.2	4.7	5.2	$\mu F$
	ESR		0.02	0.1	1	Ohm
	Shutdown Input Threshold (Note3)	$V_{OUT}+1.0V < V_{IN} < 6.0V$	0.4	0.7	1.6	V
$\overline{I}_{SHDN}$	Shutdown input Bias Current (Note3)	$\overline{V}_{SHDN}=V_{IN}$	-	0.01	100	nA
	Input Reverse Leakage Current	$V_{OUT}-V_{IN}=0.1V$	-	0.1	0.5	$\mu A$
	Reverse Protection Threshold		-	11	50	mV

Note 2 : Dropout voltage definition :  $V_{IN}-V_{OUT}$  when  $V_{OUT}$  is 2% below the value of  $V_{OUT}$  for  $V_{IN}=V_{OUT}+0.5V$

Note 3 : For 5-pin devices only.

Typical Operating Characteristics

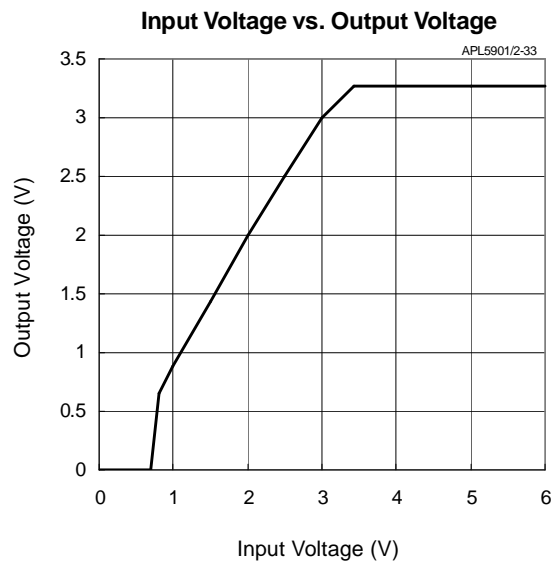
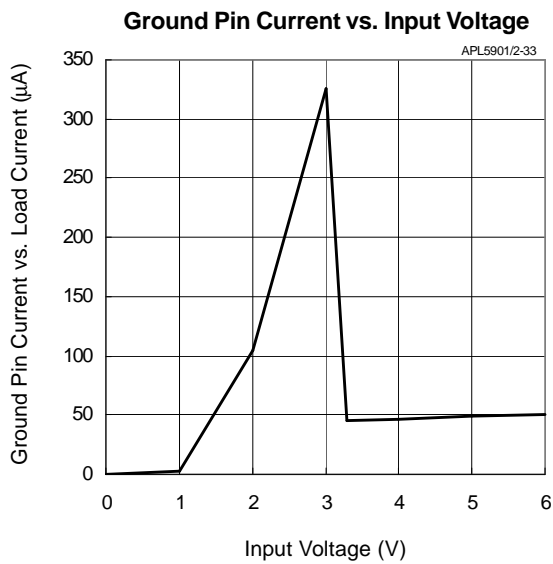
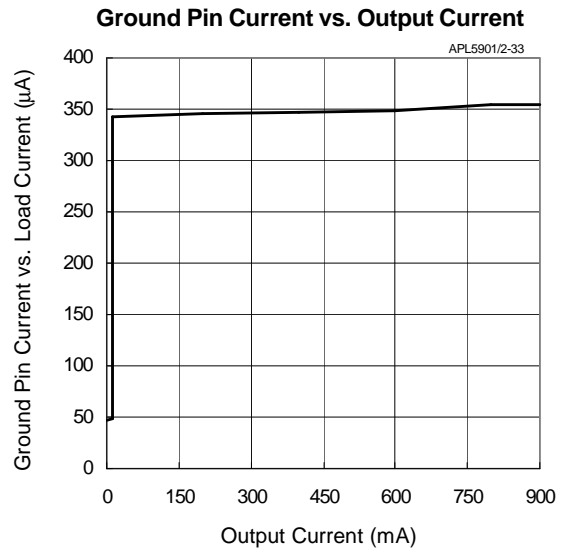
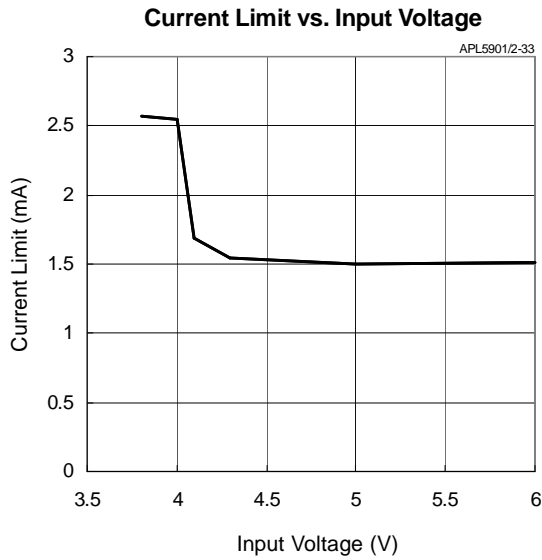

Typical Operating Characteristics (Cont.)

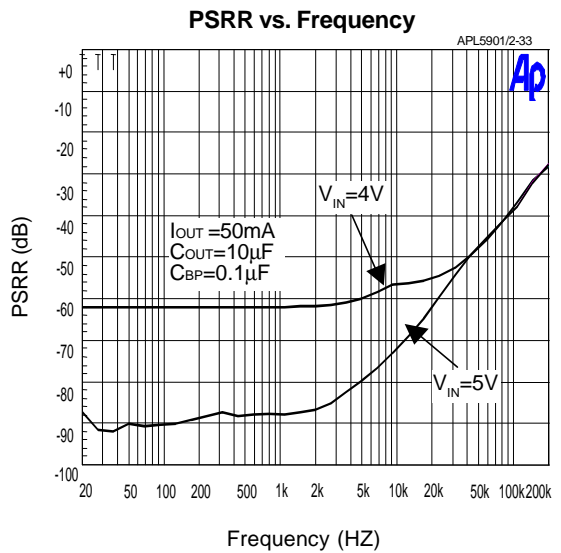
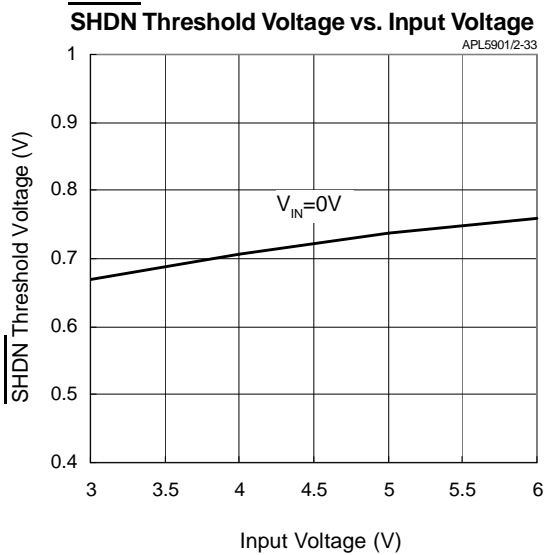
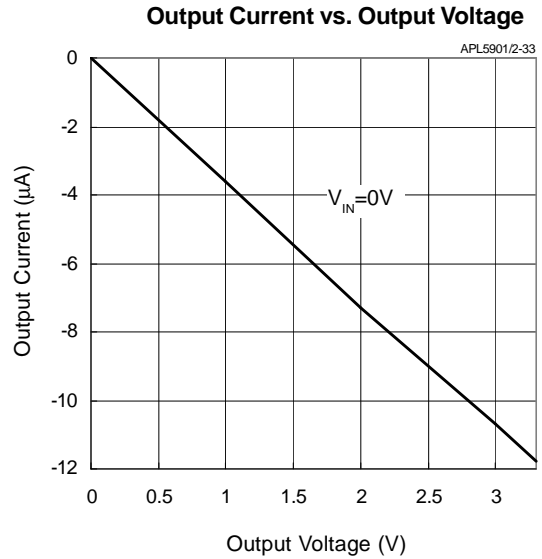
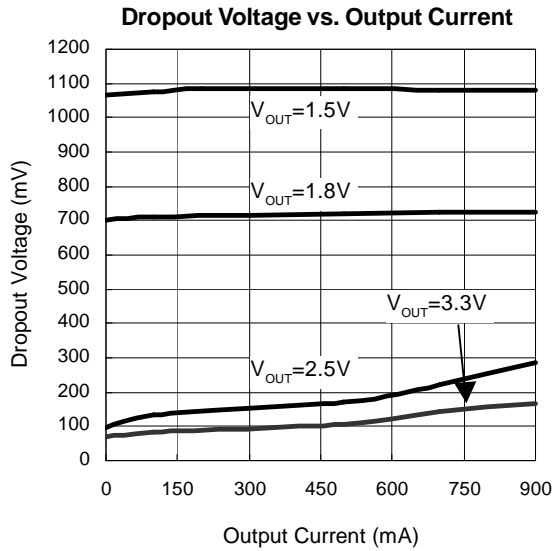

Typical Operating Characteristics (Cont.)

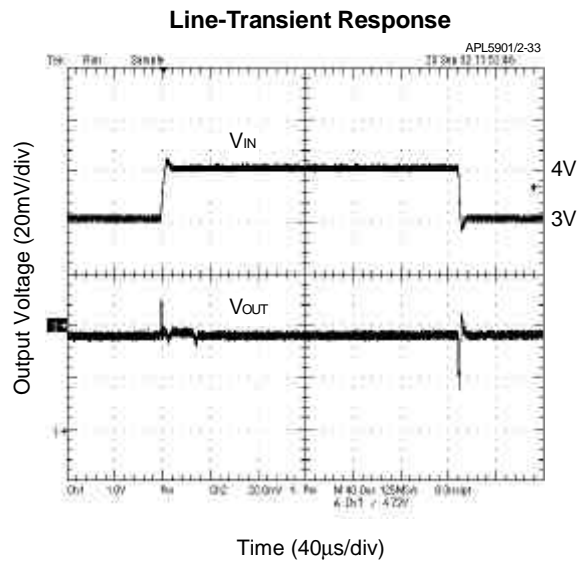
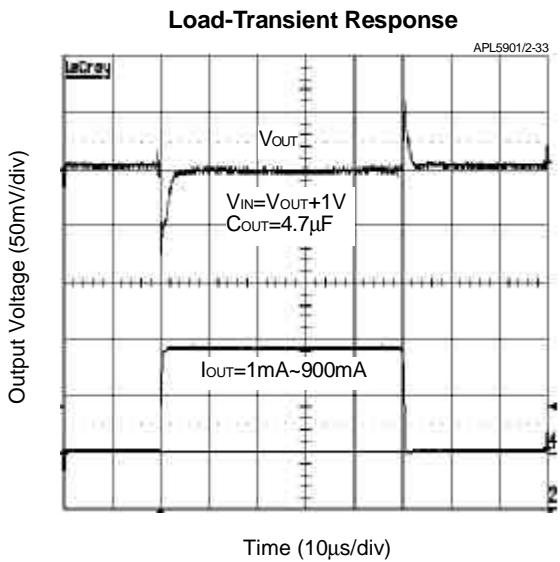
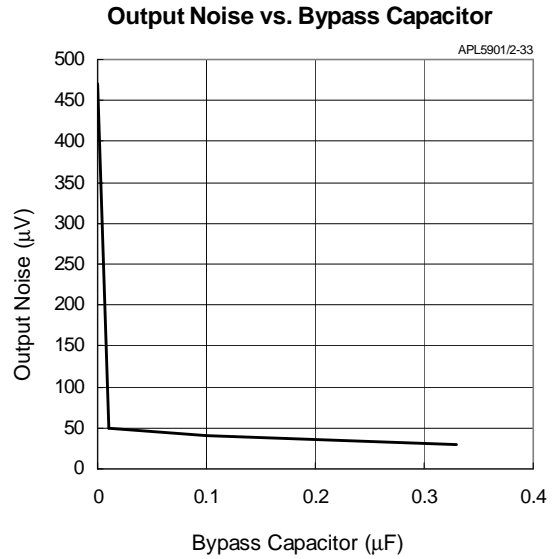
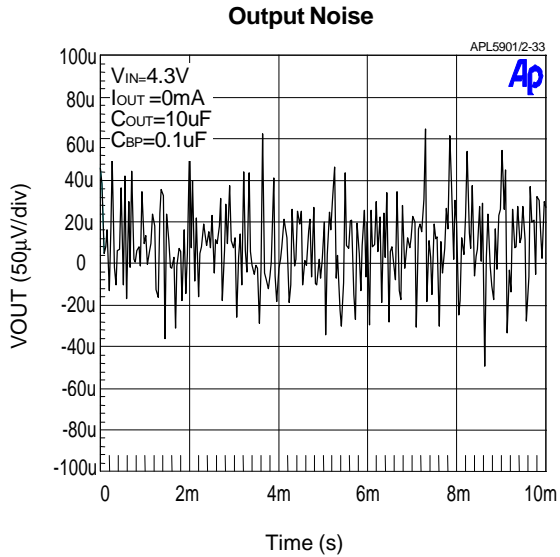

Typical Operating Characteristics (Cont.)

Shutdown Exit Delay

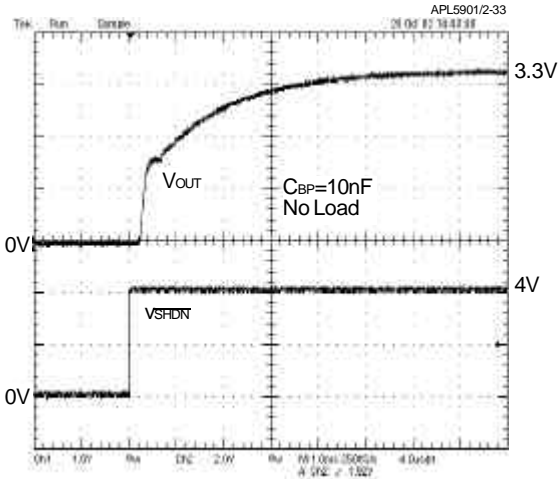

Shutdown Exit Delay

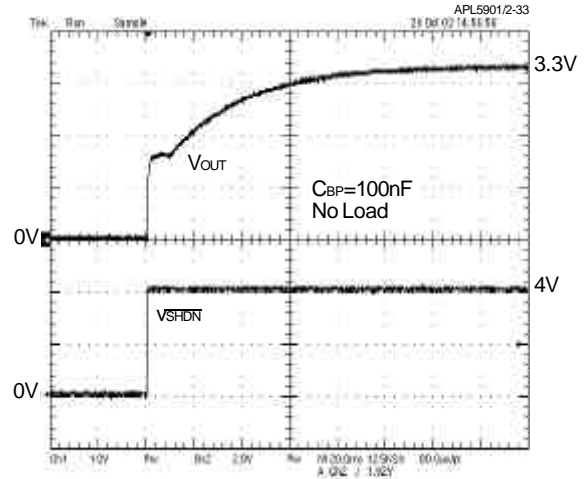

Entering Shutdown

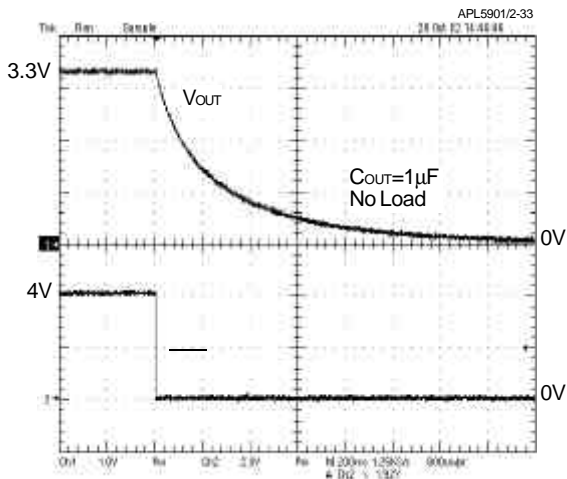

Region of Stable ESR vs. Load Current

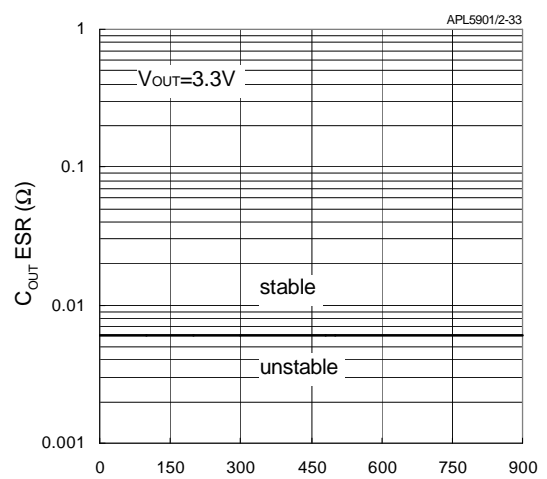



### Typical Operating Characteristics (Cont.)

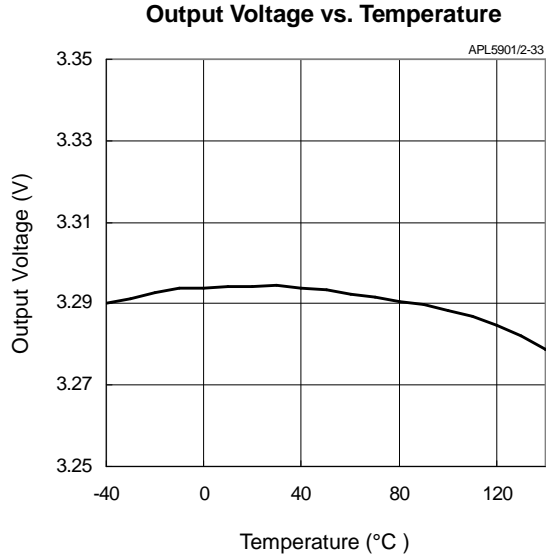

### Pin Description

PIN		I/O	FUNCTION
NO.	NAME		
1	V <sub>IN</sub>	I	Supply voltage input.
2	GND		Ground pins of the circuitry, and all ground pins must be soldered to PCB with proper power dissipation.
3	SHDN <sup>(Note 4)</sup>	I	Shutdown control pin, low = off, high = normal. Don't leave open.
4	BP <sup>(Note 4)</sup>	O	Bypass signal pin in fixed output type device
5	V <sub>OUT</sub>	O	Output pin of the regulator.

Note 4 : These pins do not exist in 3-pin package.

### Typical Application Circuit

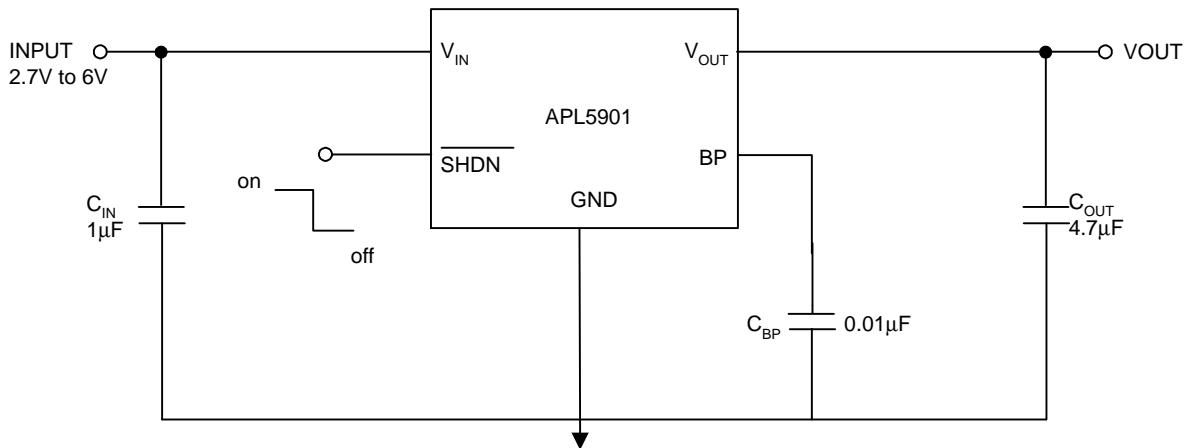

## Application Information

### Capacitor Selection and Regulator Stability

The APL5901/2 use at least a 1 $\mu$ F capacitor on the input, and this capacitor can be Aluminum, Tantalum, or Ceramic capacitor. The input capacitor with larger value and lower ESR provides better PSRR and line-transient response.

The output capacitor also can use Aluminum, Tantalum, or Ceramic capacitor, and a minimum value of 4.7 $\mu$ F and ESR above 0.02 $\Omega$  is recommended. A larger output capacitor can reduce noise and improve load-transient response, stability, and PSRR. Note that some ceramic dielectrics exhibit large capacitance and ESR variation with temperature. When using this capacitor, a minimum 10 $\mu$ F or more may be required to ensure that the stability at low temperature operation. Use a bypass capacitor at BP pin for low output noise. Increasing the capacitance will slightly decrease the output noise but increase the start-up time.

### Load-Transient Consideration

The APL5901/2 load-transient response graphs in typical characteristics show the transient response. A step change in the load current from 10mA to 900mA at 10 $\mu$ s will cause a 20mV transient spike. Larger output capacitor and lower ESR can reduce transient spike.

### Input-Output (Dropout)Voltage

The minimum input-output voltage difference (dropout) determines the lowest usable supply voltage. In battery-powered systems, this will determine the useful end-of-life battery voltage. Because the APL5901/2 use a p-channel MOSFET pass transistor, the dropout voltage is the function of drain-to-source on-resistance ( $R_{DS(ON)}$ ) multiplied by the load current.

### Reverse Current Protection

The APL5901/2 have an internal reverse protection, it does not need an external schottky diode to connect the regulator input and output. If the output voltage is forced above the input voltage by more than 11mV, the IC will be shutdown and the ground pin current is below 0.1 $\mu$ A.

### Shutdown/Enable

The APL5901/2 have an active high enable function. Force EN high (>1.6V) enables the regulator, EN low (<0.4V) disables the regulator and enter the shutdown mode. In

shutdown mode, the quiescent current can reduce below 1 $\mu$ A. The EN pin cannot be floating, a floating EN pin may cause an indeterminate state on the output. If it is no use, connect to  $V_{IN}$  for normal operation.

### Current Limit

The APL5901/2 have a current-limit protection. The output voltage will drop close to zero volt when load current reaches the limit, and then the load current will be limited at 200mA after output voltage is below 0.7V. When the load current back to the value where limiting started, the output voltage and current will return to normal value. When output is shorted to the ground, the APL5901/2 will keep short circuit current at 200mA .

### Thermal Protection

Thermal protection limits total power dissipation in the device. When the junction temperature exceeds  $T_J=+15^\circ\text{C}$ , the thermal sensor generates a logic signal to turn off the pass transistor and allows IC to cool. When the IC's junction temperature is down by 10 $^\circ\text{C}$ , the thermal sensor will turn the pass transistor on again, resulting in a pulsed output during continuous thermal protection. Thermal protection is designed to protect the APL5901/2 in the event of fault conditions. For continuous operation, do not exceed the absolute maximum junction temperature of  $T_J=+150^\circ\text{C}$ .

### Operating Region and Power Dissipation

The thermal resistance of the case to circuit board, and the rate of air flow all control the APL5901/2's maximum power dissipation. The power dissipation across the device is  $P_D = I_{OUT}(V_{IN}-V_{OUT})$  and the maximum power dissipation is:

$$P_{D\text{MAX}} = (T_J - T_A) / ( \theta_{JC} + \theta_{CA} )$$

where  $T_J - T_A$  is the temperature difference between the junction and ambient air,  $\theta_{JC}$  is the thermal resistance of the package, and  $\theta_{CA}$  is the thermal resistance through the printed circuit board, copper traces, and other materials to the ambient air.

The GND pin of the APL5901 provides an electrical connection to the ground and channeling heat away. If power dissipation is large, connect the GND pin to the ground using a large pad or a ground plane can improve the problem of over heat of IC.

Package Information

SOT-89

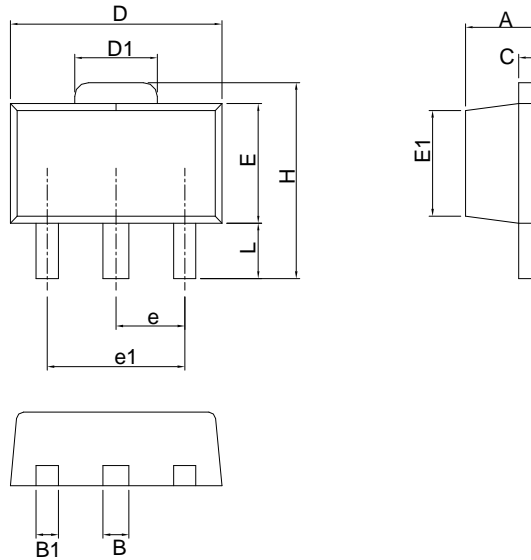

Symbol	SOT-89			
	MILLIMETERS		INCHES	
	MIN.	MAX.	MIN.	MAX.
A	1.40	1.60	0.055	0.063
B	0.44	0.56	0.017	0.022
B1	0.36	0.48	0.014	0.019
C	0.35	0.44	0.014	0.017
D	4.40	4.60	0.173	0.181
D1	1.62	1.83	0.064	0.072
E	2.29	2.60	0.090	0.102
E1	2.13	2.29	0.084	0.090
e	1.50 BSC		0.059 BSC	
e1	3.00 BSC		0.118 BSC	
H	3.94	4.25	0.155	0.167
L	0.89	1.20	0.035	0.047

Note : Follow JEDEC TO-243 AA.

Package Information

SOT-89-5

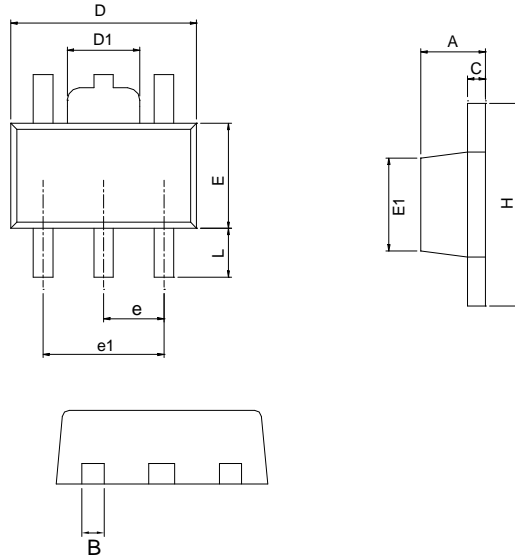

SYMBOL	SOT-89-5			
	MILLIMETERS		INCHES	
	MIN.	MAX.	MIN.	MAX.
A	1.40	1.60	0.055	0.063
B	0.36	0.56	0.014	0.022
C	0.35	0.44	0.014	0.017
D	4.40	4.60	0.173	0.181
D1	1.62	1.83	0.064	0.072
E	2.29	2.60	0.090	0.102
E1	2.13	2.29	0.084	0.090
e	1.50 BSC		0.059 BSC	
e1	3.00 BSC		0.118 BSC	
H	3.94	4.25	0.155	0.167
L	0.89	1.20	0.035	0.047

Package Information

SOT-223

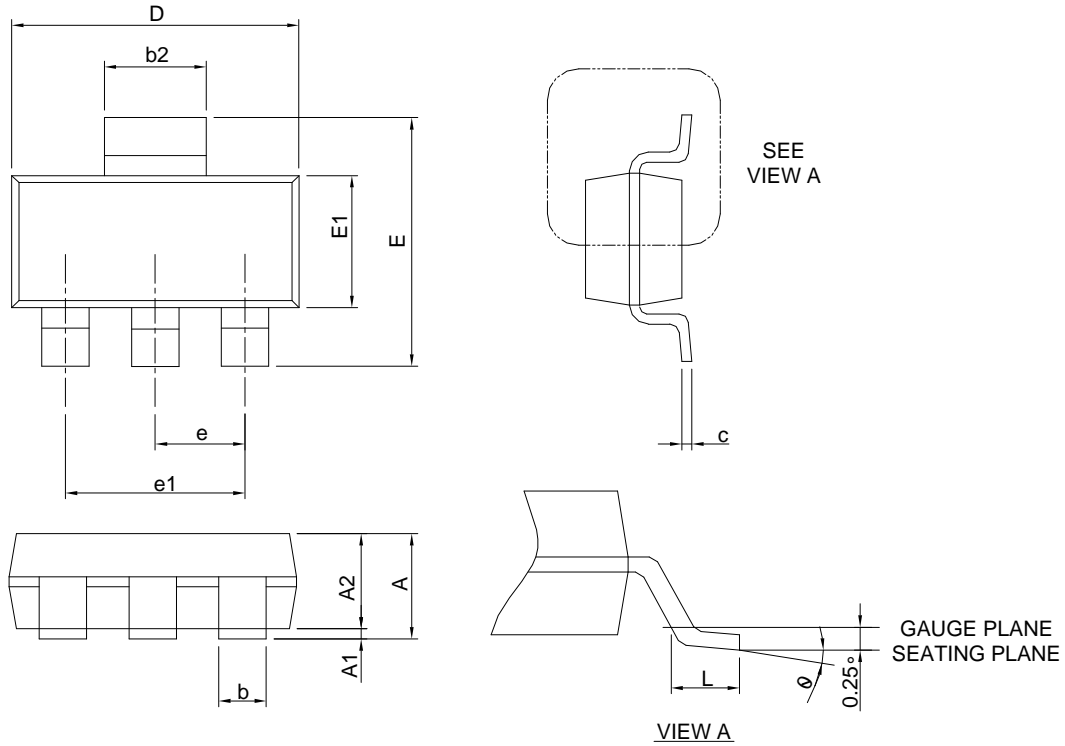

SYMBOL	SOT-223			
	MILLIMETERS		INCHES	
	MIN.	MAX.	MIN.	MAX.
A		1.80		0.071
A1	0.02	0.10	0.001	0.004
A2	1.50	1.70	0.059	0.067
b	0.66	0.84	0.026	0.033
b2	2.90	3.10	0.114	0.122
c	0.23	0.33	0.009	0.013
D	6.30	6.70	0.248	0.264
E	6.70	7.30	0.264	0.287
E1	3.30	3.70	0.130	0.146
e	2.30 BSC		0.091 BSC	
e1	4.60 BSC		0.181 BSC	
L	0.75		0.030	
$\theta$	0°	10°	0°	10°

Note : 1. Follow from JEDEC TO-261 AA.  
 2. Dimension D and E1 are determined at the outermost extremes of the plastic exclusive of mold flash, tie bar burrs, gate burrs, and interlead flash, but including any mismatch between the top and bottom of the plastic body.

Package Information

TO-252

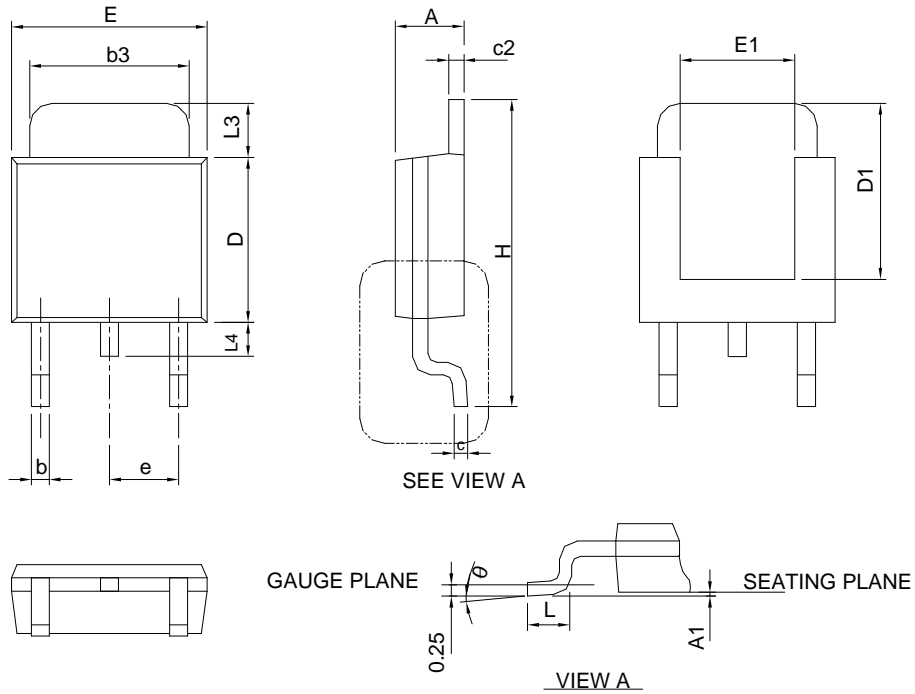

SYMBOL	TO-252			
	MILLIMETERS		INCHES	
	MIN.	MAX.	MIN.	MAX.
A	2.18	2.39	0.086	0.094
A1		0.13		0.005
b	0.50	0.89	0.020	0.035
b3	4.95	5.46	0.195	0.215
c	0.46	0.61	0.018	0.024
c2	0.46	0.89	0.018	0.035
D	5.33	6.22	0.210	0.245
D1	4.57	6.00	0.180	0.236
E	6.35	6.73	0.250	0.265
E1	3.81	6.00	0.150	0.236
e	2.29 BSC		0.090 BSC	
H	9.40	10.41	0.370	0.410
L	0.90	1.78	0.035	0.070
L3	0.89	2.03	0.035	0.080
L4		1.02		0.040
θ	0°	8°	0°	8°

Note : Follow JEDEC TO-252 .

Package Information

TO-252-5

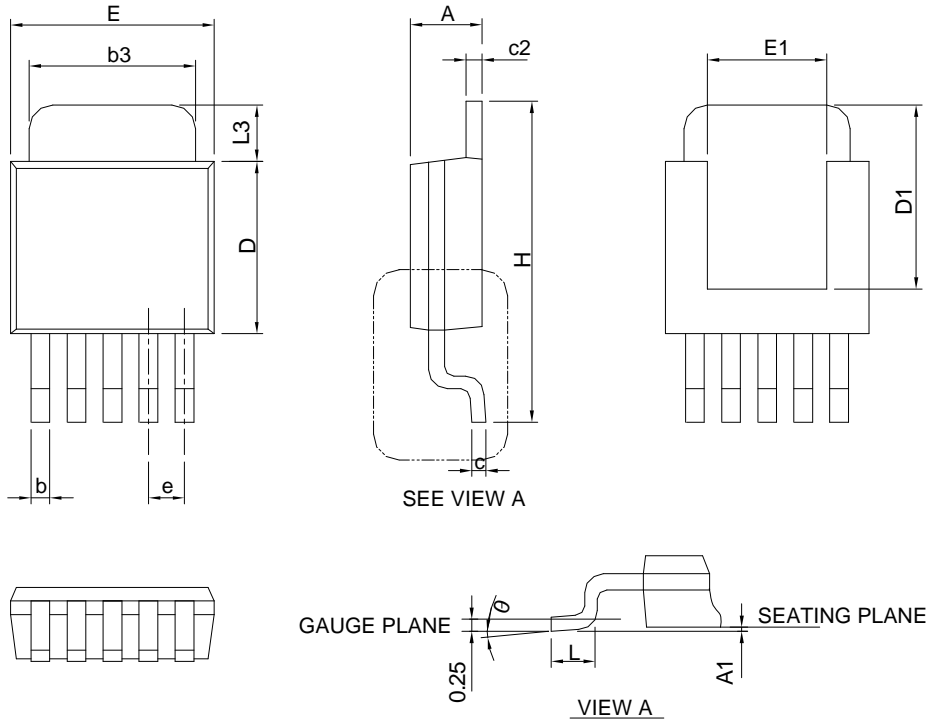

SYMBOL	TO-252-5			
	MILLIMETERS		INCHES	
	MIN.	MAX.	MIN.	MAX.
A	2.18	2.39	0.086	0.094
A1		0.13		0.005
b	0.50	0.89	0.020	0.035
b3	4.32	5.46	0.170	0.215
c	0.46	0.61	0.018	0.024
c2	0.46	0.89	0.018	0.035
D	5.33	6.22	0.210	0.245
D1	4.57	6.00	0.180	0.236
E	6.35	6.73	0.250	0.265
E1	3.81	6.00	0.150	0.236
e	1.27 BSC		0.050 BSC	
H	9.40	10.41	0.370	0.410
L	1.40	1.78	0.055	0.070
L3	0.89	2.03	0.035	0.080
$\theta$	0°	8°	0°	8°

Package Information

SOP-8

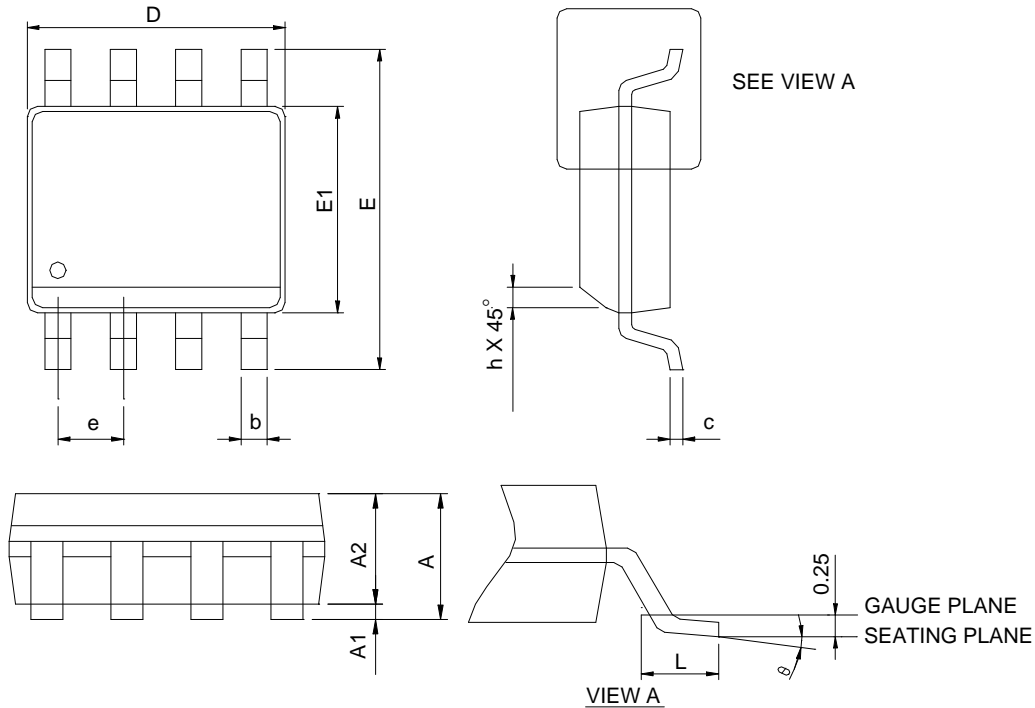

SYMBOL	SOP-8			
	MILLIMETERS		INCHES	
	MIN.	MAX.	MIN.	MAX.
A		1.75		0.069
A1	0.10	0.25	0.004	0.010
A2	1.25		0.049	
b	0.31	0.51	0.012	0.020
c	0.17	0.25	0.007	0.010
D	4.80	5.00	0.189	0.197
E	5.80	6.20	0.228	0.244
E1	3.80	4.00	0.150	0.157
e	1.27 BSC		0.050 BSC	
h	0.25	0.50	0.010	0.020
L	0.40	1.27	0.016	0.050
$\theta$	0°	8°	0°	8°

- Note: 1. Follow JEDEC MS-012 AA.  
 2. Dimension "D" does not include mold flash, protrusions or gate burrs. Mold flash, protrusion or gate burrs shall not exceed 6 mil per side.  
 3. Dimension "E" does not include inter-lead flash or protrusions. Inter-lead flash and protrusions shall not exceed 10 mil per side.



### Carrier Tape & Reel Dimensions

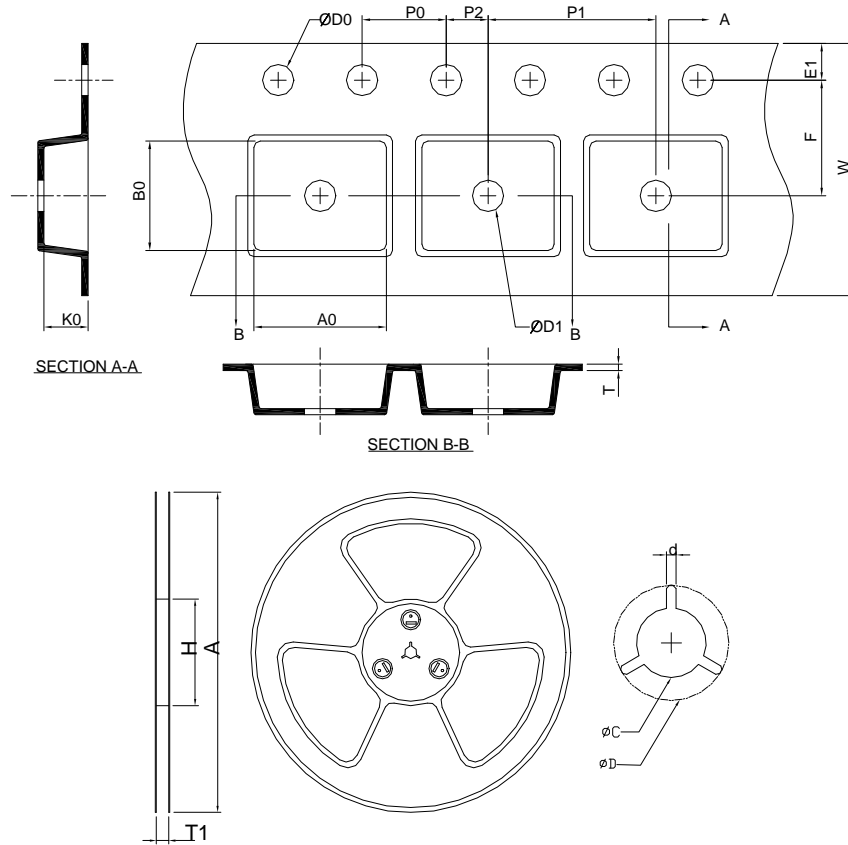

Application	A	H	T1	C	d	D	W	E1	F
SOT-89	178.0 ±0.00	50 MIN.	12.4+2.00 -0.00	13.0+0.50 -0.20	1.5 MIN.	20.2 MIN.	12.0 ±0.30	1.75 ±0.10	5.50 ±0.05
	P0	P1	P2	D0	D1	T	A0	B0	K0
	4.0 ±0.10	8.0 ±0.10	2.0 ±0.05	1.5+0.10 -0.00	1.5 MIN.	0.6+0.00 -0.40	4.80 ±0.20	4.50 ±0.20	1.80 ±0.20
Application	A	H	T1	C	d	D	W	E1	F
TO-252	330.0 ±0.00	50 MIN.	16.4+2.00 -0.00	13.0+0.50 -0.20	1.5 MIN.	20.2 MIN.	16.0 ±0.30	1.75 ±0.10	7.50 ±0.05
	P0	P1	P2	D0	D1	T	A0	B0	K0
	4.0 ±0.10	8.0 ±0.10	2.0 ±0.05	1.5+0.10 -0.00	1.5 MIN.	0.6+0.00 -0.40	6.80 ±0.20	10.40 ±0.20	2.50 ±0.20
Application	A	H	T1	C	d	D	W	E1	F
SOT-223	320.0 ±0.00	50 MIN.	12.4+2.00 -0.00	13.0+0.50 -0.20	1.5 MIN.	20.2 MIN.	12.00 ±0.30	1.75 ±0.10	5.50 ±0.05
	P0	P1	P2	D0	D1	T	A0	B0	K0
	4.00 ±0.10	8.00 ±0.10	2.00 ±0.50	1.5+0.10 -0.00	1.5 MIN.	0.6+0.00 -0.40	6.90 ±0.20	7.50 ±0.20	2.10 ±0.20
Application	A	H	T1	C	d	D	W	E1	F
SOP-8	330.0 ±0.00	50 MIN.	12.4+2.00 -0.00	13.0+0.50 -0.20	1.5 MIN.	20.2 MIN.	12.0 ±0.30	1.75 ±0.10	5.5 ±0.05
	P0	P1	P2	D0	D1	T	A0	B0	K0
	4.0 ±0.10	8.0 ±0.10	2.0 ±0.05	1.5+0.10 -0.00	1.5 MIN.	0.6+0.00 -0.40	6.40 ±0.20	5.20 ±0.20	2.10 ±0.20

**Devices Per Unit**

Package Type	Unit	Quantity
SOT-89	Tape & Reel	1000
TO-252	Tape & Reel	2500
SOT-223	Tape & Reel	2500
SOP-8	Tape & Reel	2500

**Taping Direction Information**

**SOT-89**

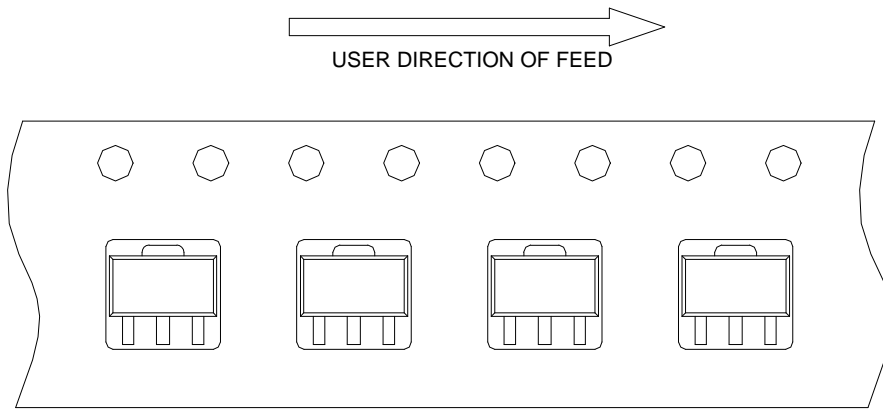

**TO-252**

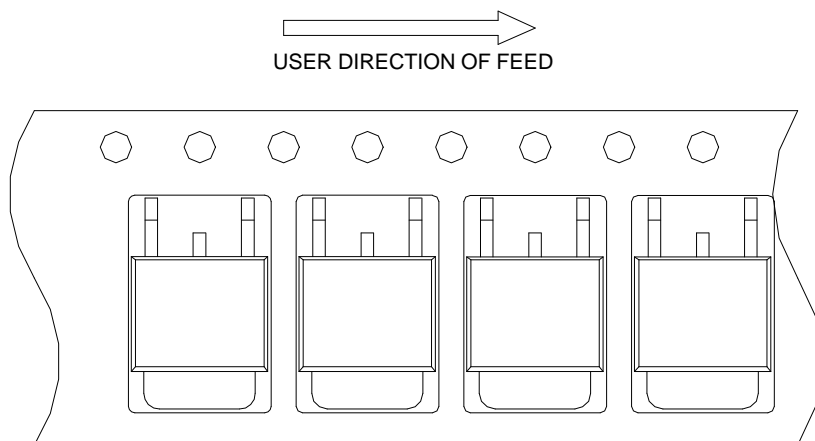

### Taping Direction Information

SOT-223

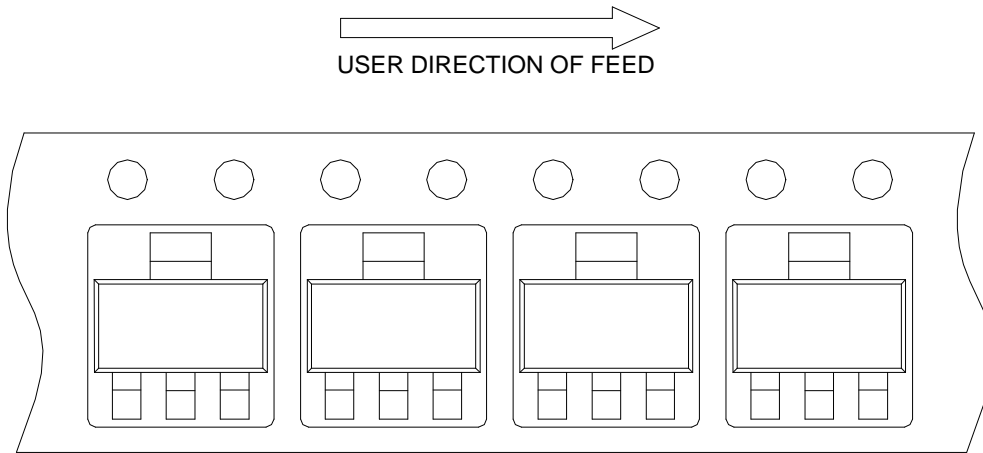

SOP-8

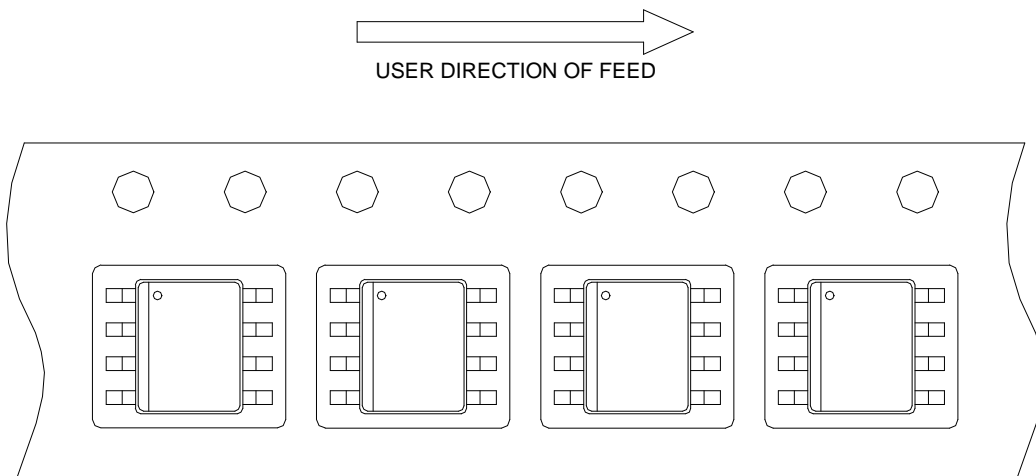

**Reflow Condition (IR/Convection or VPR Reflow)**

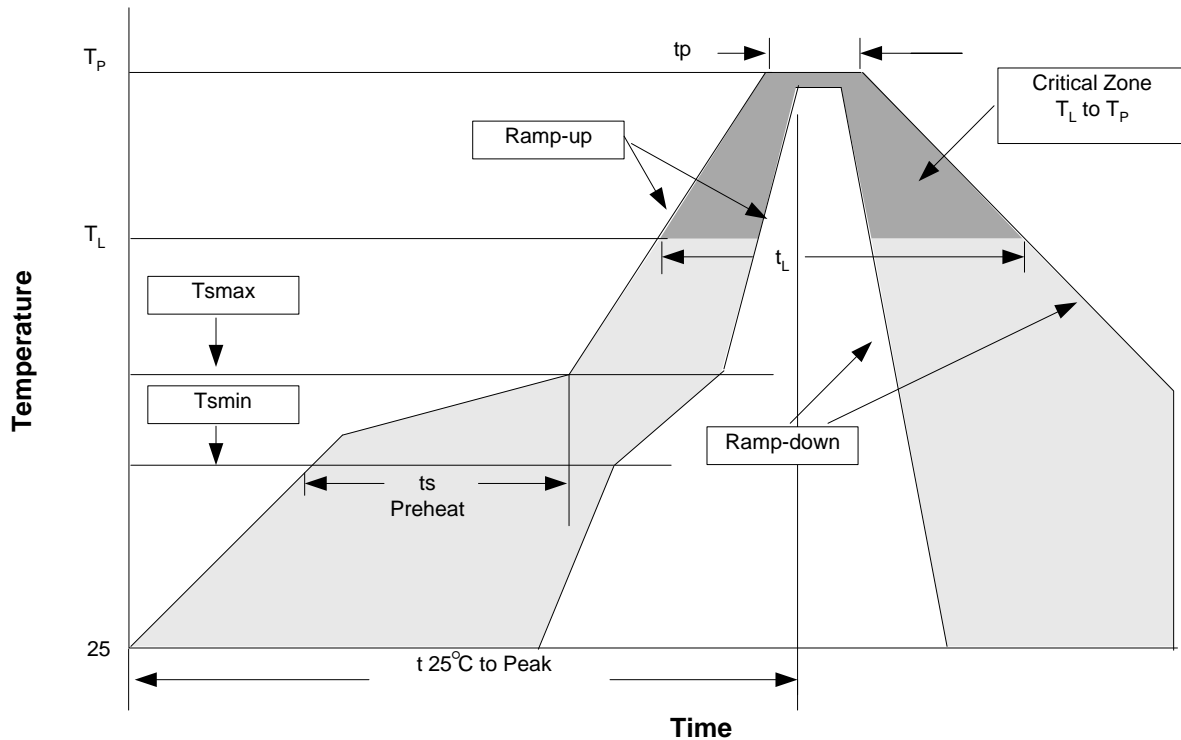

**Reliability Test Program**

Test item	Method	Description
SOLDERABILITY	MIL-STD-883D-2003	245°C, 5 sec
HOLT	MIL-STD-883D-1005.7	1000 Hrs Bias @ 125°C
PCT	JESD-22-B, A102	168 Hrs, 100%RH, 121°C
TST	MIL-STD-883D-1011.9	-65°C~150°C, 200 Cycles
ESD	MIL-STD-883D-3015.7	VHBM > 2KV, VMM > 200V
Latch-Up	JESD 78	10ms, 1 <sub>tr</sub> > 100mA

**Classification Reflow Profiles**

Profile Feature	Sn-Pb Eutectic Assembly	Pb-Free Assembly
Average ramp-up rate (T <sub>L</sub> to T <sub>P</sub> )	3°C/second max.	3°C/second max.
Preheat		
- Temperature Min (T <sub>smin</sub> )	100°C	150°C
- Temperature Max (T <sub>smax</sub> )	150°C	200°C
- Time (min to max) (t <sub>s</sub> )	60-120 seconds	60-180 seconds
Time maintained above:		
- Temperature (T <sub>L</sub> )	183°C	217°C
- Time (t <sub>L</sub> )	60-150 seconds	60-150 seconds
Peak/Classification Temperature (T <sub>p</sub> )	See table 1	See table 2
Time within 5°C of actual Peak Temperature (t <sub>p</sub> )	10-30 seconds	20-40 seconds
Ramp-down Rate	6°C/second max.	6°C/second max.
Time 25°C to Peak Temperature	6 minutes max.	8 minutes max.

Note: All temperatures refer to topside of the package. Measured on the body surface.

**Classification Reflow Profiles (Cont.)**

Table 1. SnPb Eutectic Process – Package Peak Reflow Temperatures

Package Thickness	Volume mm <sup>3</sup> <350	Volume mm <sup>3</sup> ≥350
<2.5 mm	240 +0/-5°C	225 +0/-5°C
≥2.5 mm	225 +0/-5°C	225 +0/-5°C

Table 2. Pb-free Process – Package Classification Reflow Temperatures

Package Thickness	Volume mm <sup>3</sup> <350	Volume mm <sup>3</sup> 350-2000	Volume mm <sup>3</sup> >2000
<1.6 mm	260 +0°C*	260 +0°C*	260 +0°C*
1.6 mm – 2.5 mm	260 +0°C*	250 +0°C*	245 +0°C*
≥2.5 mm	250 +0°C*	245 +0°C*	245 +0°C*

\* Tolerance: The device manufacturer/supplier **shall** assure process compatibility up to and including the stated classification temperature (this means Peak reflow temperature +0°C. For example 260°C+0°C) at the rated MSL level.

**Customer Service**

**Anpec Electronics Corp.**

Head Office :

No.6, Dusing 1st Road, SBIP,  
Hsin-Chu, Taiwan, R.O.C.  
Tel : 886-3-5642000  
Fax : 886-3-5642050

Taipei Branch :

2F, No. 11, Lane 218, Sec 2 Jhongsing Rd.,  
Sindian City, Taipei County 23146, Taiwan  
Tel : 886-2-2910-3838  
Fax : 886-2-2917-3838