

# APM2054ND



## N-Channel Enhancement Mode MOSFET

### Features

- 20V/5A,  
 $R_{DS(ON)}=35m\Omega(\text{typ.}) @ V_{GS}=10V$   
 $R_{DS(ON)}=45m\Omega(\text{typ.}) @ V_{GS}=4.5V$   
 $R_{DS(ON)}=110m\Omega(\text{typ.}) @ V_{GS}=2.5V$
- Super High Dense Cell Design
- Reliable and Rugged
- Lead Free Available (RoHS Compliant)

### Applications

- Switching Regulators
- Switching Converters

### Pin Description

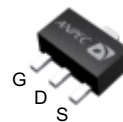

Top View of SOT-89

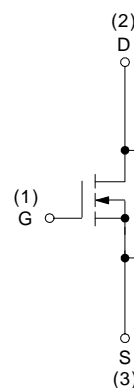

N-Channel MOSFET

### Ordering and Marking Information

<p>APM2054N □□-□□□</p> <p>Lead Free Code          Handling Code          Temp. Range          Package Code</p>	<p>Package Code          D : SOT-89          Operating Junction Temp. Range          C : -55 to 150°C          Handling Code          TU : Tube    TR : Tape &amp; Reel          Lead Free Code          L : Lead Free Device    Blank : Original Device</p>
<p>APM2054N D: <span style="border: 1px solid black; padding: 2px;">APM2054 XXXXX</span></p>	<p>XXXXX - Date Code</p>

Note: ANPEC lead-free products contain molding compounds/die attach materials and 100% matte in plate termination finish; which are fully compliant with RoHS and compatible with both SnPb and lead-free soldering operations. ANPEC lead-free products meet or exceed the lead-free requirements of IPC/JEDEC J STD-020C for MSL classification at lead-free peak reflow temperature.

ANPEC reserves the right to make changes to improve reliability or manufacturability without notice, and advise customers to obtain the latest version of relevant information to verify before placing orders.

**APM2054ND****Absolute Maximum Ratings** ( $T_A = 25^\circ\text{C}$  unless otherwise noted)

Symbol	Parameter	Rating	Unit	
$V_{DSS}$	Drain-Source Voltage	20	V	
$V_{GSS}$	Gate-Source Voltage	$\pm 16$		
$I_D^*$	Continuous Drain Current	5	A	
$I_{DM}^*$	Pulsed Drain Current			20
$I_S^*$	Diode Continuous Forward Current	3	A	
$T_J$	Maximum Junction Temperature	150	$^\circ\text{C}$	
$T_{STG}$	Storage Temperature Range	-55 to 150		
$P_D^*$	Power Dissipation for Single Operation	$T_A=25^\circ\text{C}$	1.47	W
		$T_A=100^\circ\text{C}$	0.58	
$R_{\theta JA}^*$	Thermal Resistance-Junction to Ambient	85	$^\circ\text{C}/\text{W}$	

Note:

\*Surface Mounted on  $1\text{in}^2$  pad area,  $t \leq 10\text{sec}$ .**Electrical Characteristics** ( $T_A = 25^\circ\text{C}$  unless otherwise noted)

Symbol	Parameter	Test Condition	APM2054ND			Unit
			Min.	Typ.	Max.	
<b>Static Characteristics</b>						
$BV_{DSS}$	Drain-Source Breakdown Voltage	$V_{GS}=0\text{V}, I_{DS}=250\mu\text{A}$	20			V
$I_{DSS}$	Zero Gate Voltage Drain Current	$V_{DS}=16\text{V}, V_{GS}=0\text{V}$ $T_J=85^\circ\text{C}$			1	$\mu\text{A}$
					30	
$V_{GS(th)}$	Gate Threshold Voltage	$V_{DS}=V_{GS}, I_{DS}=250\mu\text{A}$	0.6	0.9	1.5	V
$I_{GSS}$	Gate Leakage Current	$V_{GS}=\pm 16\text{V}, V_{DS}=0\text{V}$			$\pm 100$	nA
$R_{DS(ON)}^a$	Drain-Source On-state Resistance	$V_{GS}=10\text{V}, I_{DS}=5\text{A}$		35	40	m $\Omega$
		$V_{GS}=4.5\text{V}, I_{DS}=3.5\text{A}$		45	54	
		$V_{GS}=2.5\text{V}, I_{DS}=2.5\text{A}$		110	130	
$V_{SD}^a$	Diode Forward Voltage	$I_{SD}=3\text{A}, V_{GS}=0\text{V}$		0.7	1.3	V
<b>Dynamic Characteristics</b> <sup>b</sup>						
$t_{d(ON)}$	Turn-on Delay Time	$V_{DD}=10\text{V}, R_L=10\Omega,$ $I_{DS}=1\text{A}, V_{GEN}=4.5\text{V},$ $R_G=6\Omega$		7	10	ns
$T_r$	Turn-on Rise Time			15	25	
$t_{d(OFF)}$	Turn-off Delay Time			19	26	
$T_f$	Turn-off Fall Time			6	7	

**APM2054ND****Electrical Characteristics (Cont.)** ( $T_A = 25^\circ\text{C}$  unless otherwise noted)

Symbol	Parameter	Test Condition	APM2054ND			Unit
			Min.	Typ.	Max.	
<b>Dynamic Characteristics</b> <sup>b</sup>						
$R_G$	Gate Resistance	$V_{GS}=0V, V_{DS}=0V, F=1\text{MHz}$		2.5		$\Omega$
$C_{iss}$	Input Capacitance	$V_{GS}=0V,$ $V_{DS}=15V,$ Frequency=1.0MHz		450		pF
$C_{oss}$	Output Capacitance			100		
$C_{rss}$	Reverse Transfer Capacitance			60		
<b>Gate Charge Characteristics</b> <sup>b</sup>						
$Q_g$	Total Gate Charge	$V_{DS}=10V, V_{GS}=4.5V,$ $I_{DS}=5A$		11.5	15	nC
$Q_{gs}$	Gate-Source Charge			3.8		
$Q_{gd}$	Gate-Drain Charge			5.2		

Notes:

- a : Pulse test ; pulse width  $\leq 300\mu\text{s}$ , duty cycle  $\leq 2\%$ .  
 b : Guaranteed by design, not subject to production testing.

## Typical Characteristics

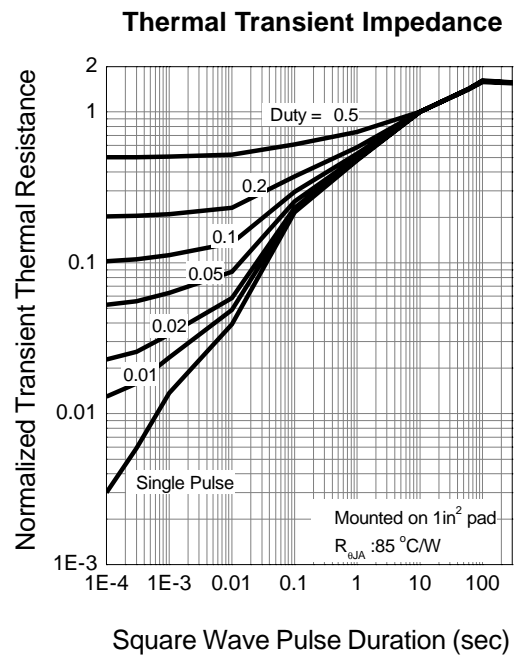
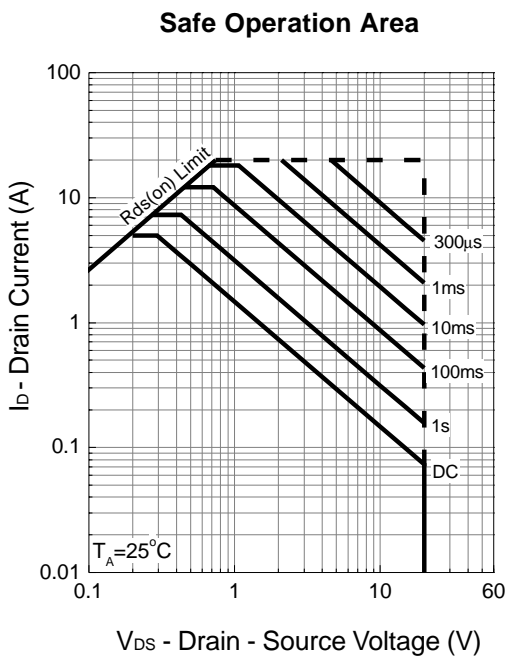
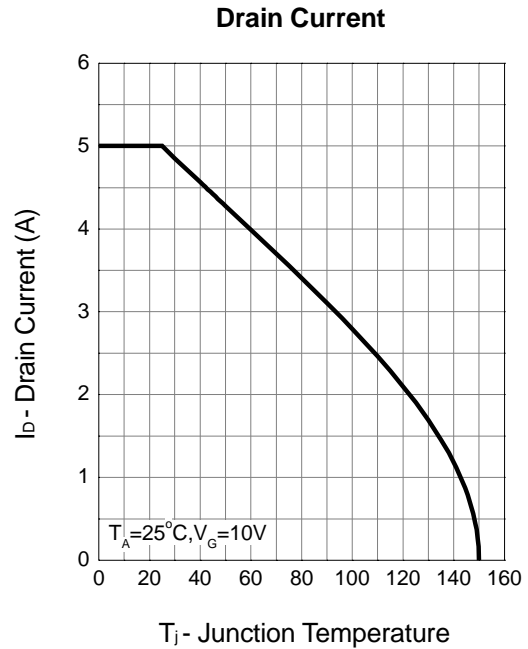
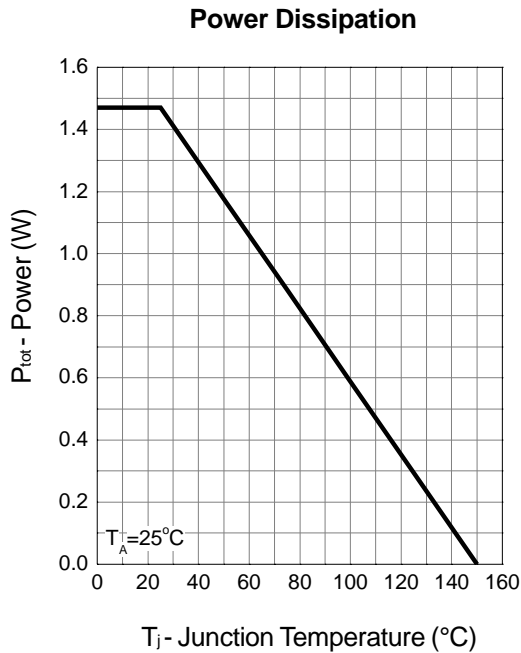

## Typical Characteristics (Cont.)

### Output Characteristics

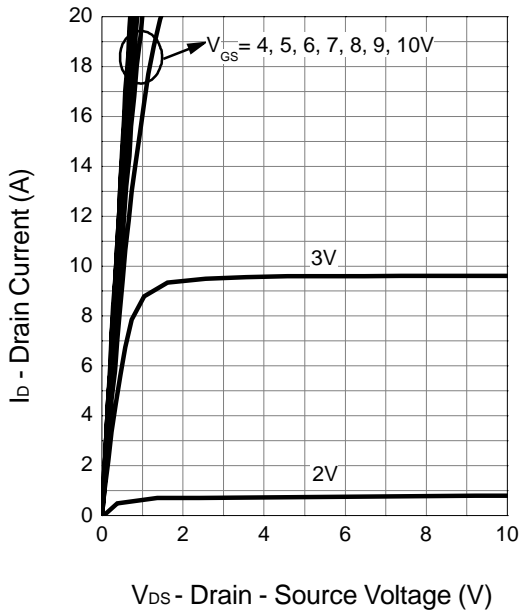

### Drain-Source On Resistance

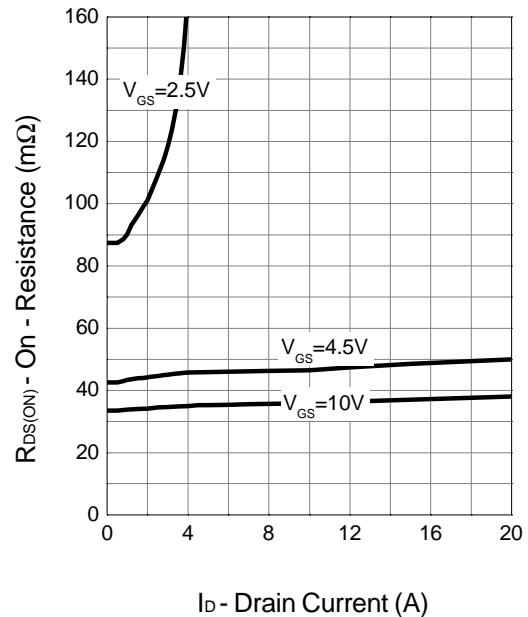

### Transfer Characteristics

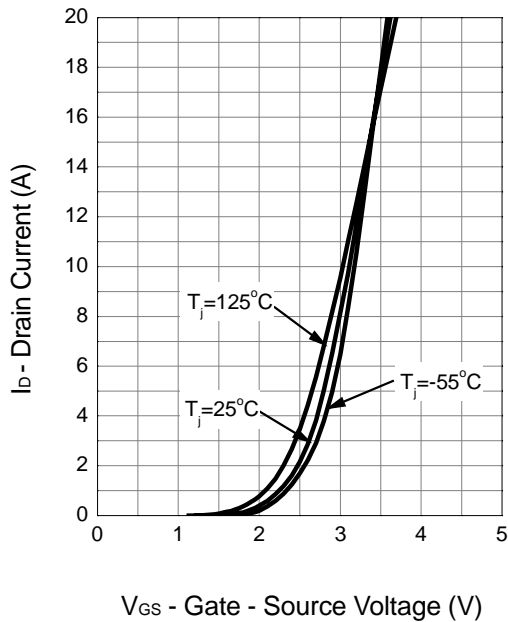

### Gate Threshold Voltage

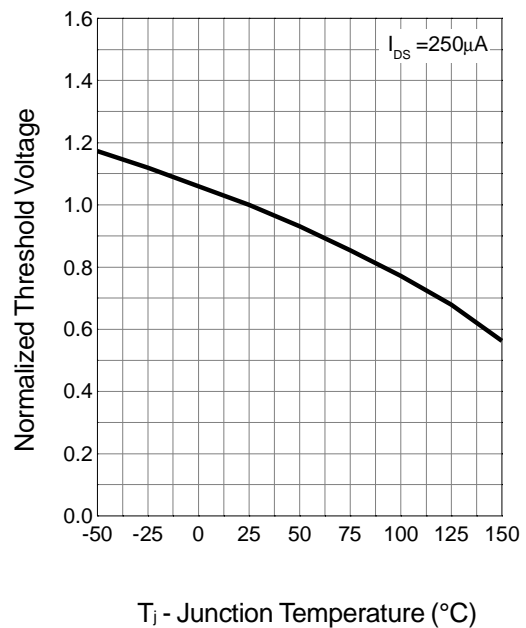

et4U.com

DataSheet4U.com

DataShe

## Typical Characteristics (Cont.)

### Drain-Source On Resistance

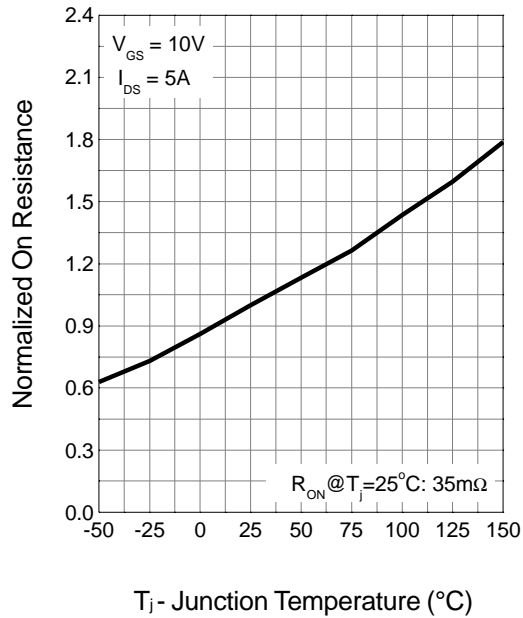

### Source-Drain Diode Forward

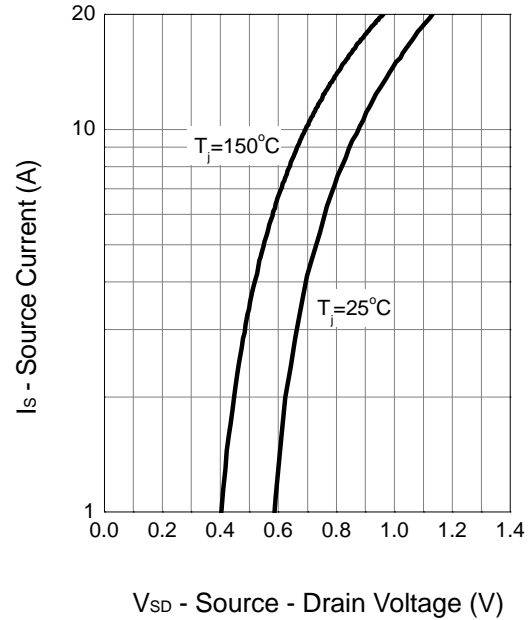

$T_j$  - Junction Temperature ( $^{\circ}\text{C}$ )

$V_{SD}$  - Source - Drain Voltage (V)

DataSheet4U.com

### Capacitance

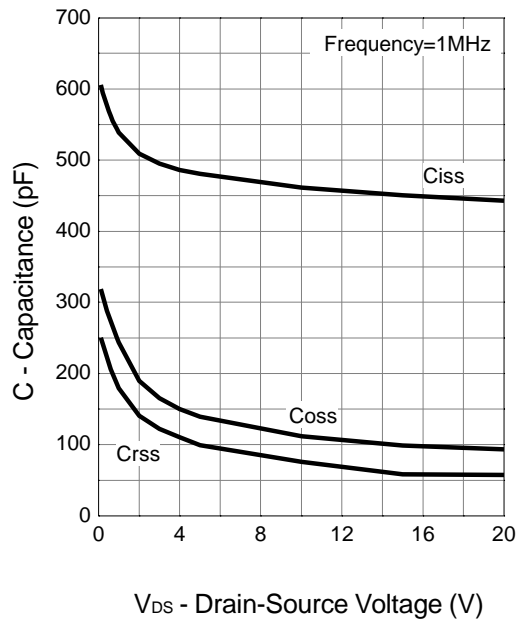

$V_{DS}$  - Drain-Source Voltage (V)

### Gate Charge

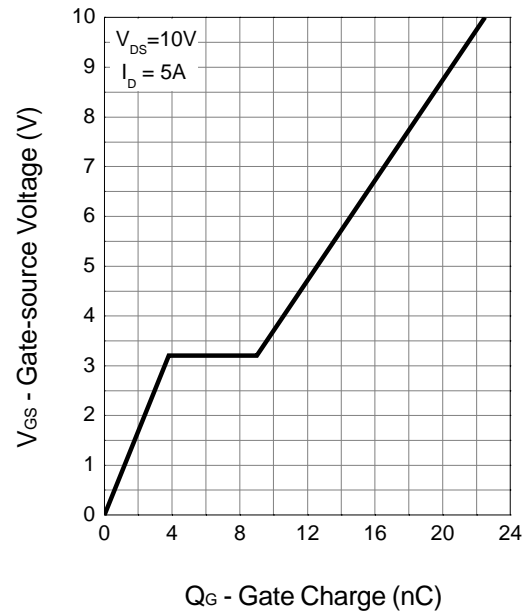

$Q_G$  - Gate Charge (nC)

**APM2054ND****Package Information**

SOT-89 (Reference EIAJ ED-7500A Registration SC-62)

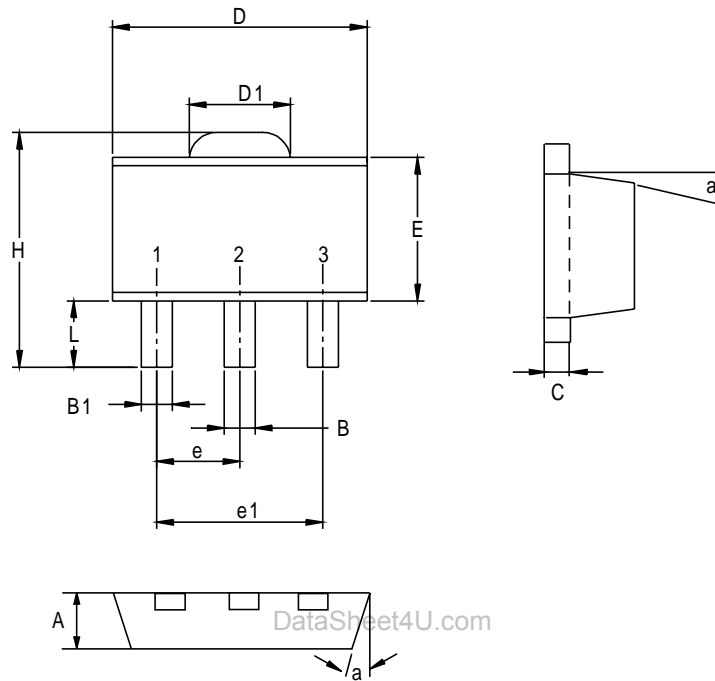

Dim	Millimeters		Inches	
	Min.	Max.	Min.	Max.
A	1.40	1.60	0.055	0.063
B	0.40	0.56	0.016	0.022
B1	0.35	0.48	0.014	0.019
C	0.35	0.44	0.014	0.017
D	4.40	4.60	0.173	0.181
D1	1.35	1.83	0.053	0.072
e	1.50 BSC		0.059 BSC	
e1	3.00 BSC		0.118 BSC	
E	2.29	2.60	0.090	0.102
H	3.75	4.25	0.148	0.167
L	0.80	1.20	0.031	0.047
α		10°		10°

## Physical Specifications

Terminal Material	Solder-Plated Copper (Solder Material : 90/10 or 63/37 SnPb), 100%Sn
Lead Solderability	Meets EIA Specification RSI86-91, ANSI/J-STD-002 Category 3.

### Reflow Condition (IR/Convection or VPR Reflow)

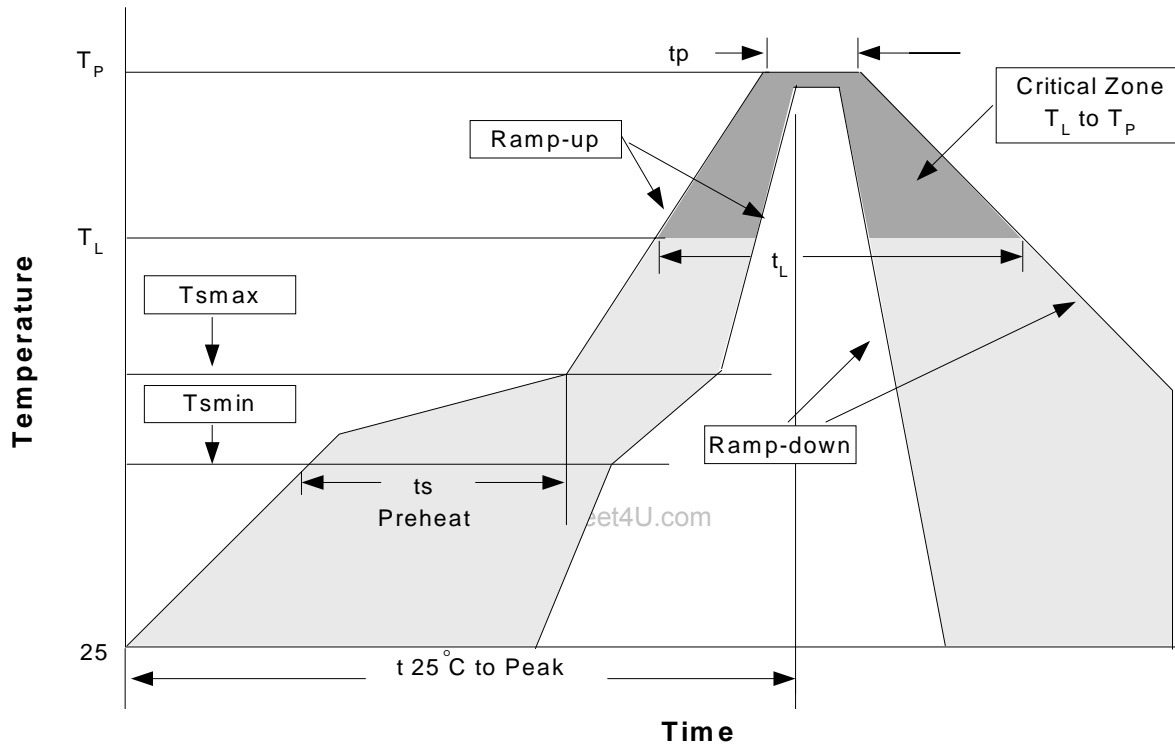

### Classification Reflow Profiles

Profile Feature	Sn-Pb Eutectic Assembly	Pb-Free Assembly
Average ramp-up rate (T <sub>L</sub> to T <sub>p</sub> )	3°C/second max.	3°C/second max.
Preheat		
- Temperature Min (T <sub>sm</sub> )	100°C	150°C
- Temperature Max (T <sub>sm</sub> )	150°C	200°C
- Time (min to max) (t <sub>s</sub> )	60-120 seconds	60-180 seconds
Time maintained above:		
- Temperature (T <sub>L</sub> )	183°C	217°C
- Time (t <sub>L</sub> )	60-150 seconds	60-150 seconds
Peak/Classification Temperature (T <sub>p</sub> )	See table 1	See table 2
Time within 5°C of actual Peak Temperature (t <sub>p</sub> )	10-30 seconds	20-40 seconds
Ramp-down Rate	6°C/second max.	6°C/second max.
Time 25°C to Peak Temperature	6 minutes max.	8 minutes max.

Notes: All temperatures refer to topside of the package. Measured on the body surface.



## Classification Reflow Profiles(Cont.)

Table 1. SnPb Eutectic Process – Package Peak Reflow Temperatures

Package Thickness	Volume mm <sup>3</sup> <350	Volume mm <sup>3</sup> ≥350
<2.5 mm	240 +0/-5°C	225 +0/-5°C
≥2.5 mm	225 +0/-5°C	225 +0/-5°C

Table 2. Pb-free Process – Package Classification Reflow Temperatures

Package Thickness	Volume mm <sup>3</sup> <350	Volume mm <sup>3</sup> 350-2000	Volume mm <sup>3</sup> >2000
<1.6 mm	260 +0°C*	260 +0°C*	260 +0°C*
1.6 mm – 2.5 mm	260 +0°C*	250 +0°C*	245 +0°C*
≥2.5 mm	250 +0°C*	245 +0°C*	245 +0°C*

\*Tolerance: The device manufacturer/supplier **shall** assure process compatibility up to and including the stated classification temperature (this means Peak reflow temperature +0°C. For example 260°C+0°C) at the rated MSL level.

## Reliability test program

Test item	Method	Description
SOLDERABILITY	MIL-STD-883D-2003	245°C, 5 SEC
HOLT	MIL-STD-883D-1005.7	1000 Hrs Bias @ 125°C
PCT	JESD-22-B,A102	168 Hrs, 100%RH, 121°C
TST	MIL-STD-883D-1011.9	-65°C~150°C, 200 Cycles

## Carrier Tape & Reel Dimensions

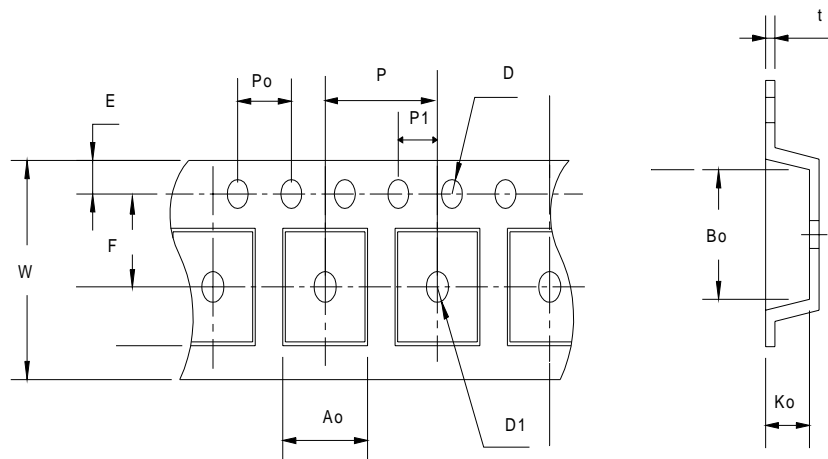

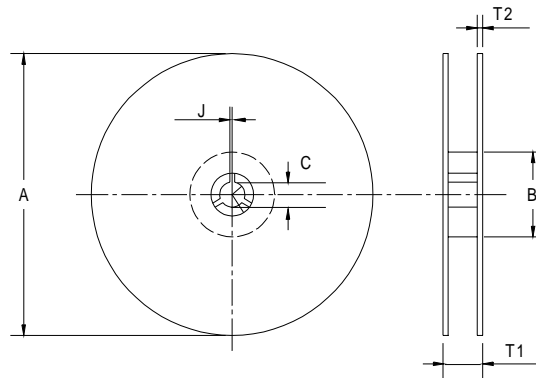
**Carrier Tape & Reel Dimensions(Cont.)**

Application	A	B	C	J	T1	T2	W	P	E
SOT-89	178 ± 1	70 ± 2	13.5 ± 0.15	3 ± 0.15	14 ± 2	1.3 ± 0.3	12 + 0.3 12 - 0.1	8 ± 0.1	1.75 ± 0.1
	F	D	D1	Po	P1	Ao	Bo	Ko	t
	5.5 ± 0.05	1.5 ± 0.1	1.5 ± 0.1	4.0 ± 0.1	2.0 ± 0.1	4.8 ± 0.1	4.5 ± 0.1	1.80 ± 0.1	0.3 ± 0.013

(mm)

**Cover Tape Dimensions**

DataSheet4U.com

Application	Carrier Width	Cover Tape Width	Devices Per Reel
SOT-89	12	9.3	1000

**Customer Service****Anpec Electronics Corp.**

Head Office :

5F, No. 2 Li-Hsin Road, SBIP,

Hsin-Chu, Taiwan, R.O.C.

Tel : 886-3-5642000

Fax : 886-3-5642050

Taipei Branch :

7F, No. 137, Lane 235, Pac Chiao Rd.,

Hsin Tien City, Taipei Hsien, Taiwan, R. O. C.

Tel : 886-2-89191368

Fax : 886-2-89191369