

## N-Channel Enhancement Mode MOSFET

### Features

- 25V/50A,  
 $R_{DS(ON)} = 8m\Omega$  (Typ.) @  $V_{GS} = 10V$   
 $R_{DS(ON)} = 15m\Omega$  (Typ.) @  $V_{GS} = 4.5V$
- Super High Dense Cell Design
- Reliable and Rugged
- Avalanche Rated
- Lead Free and Green Devices Available (RoHS Compliant)

### Applications

- Power Management in Desktop Computer or DC/DC Converters

### Pin Description

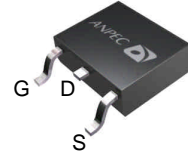

Top View of TO-252

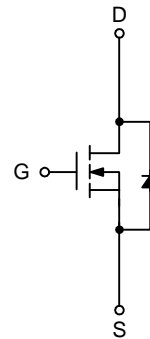

N-Channel MOSFET

### Ordering and Marking Information

|  |  |
|--|--|
| <p>APM2518N <span style="font-family: monospace;">□□-□□□</span></p> <div style="margin-left: 20px;"> <p>└─ Assembly Material</p> <p>└─ Handling Code</p> <p>└─ Temperature Range</p> <p>└─ Package Code</p> </div> | <p>Package Code<br/>U : TO-252</p> <p>Operating Junction Temperature Range<br/>C : -55 to 150 °C</p> <p>Handling Code<br/>TR : Tape &amp; Reel</p> <p>Assembly Material<br/>G : Halogen and Lead Free Device</p> |
| <p>APM2518N U :</p> <div style="border: 1px solid black; padding: 2px; display: inline-block; margin-left: 10px;"> <p style="margin: 0; padding: 0;">APM2518N<br/>XXXXX</p> </div>                                 | <p>XXXXX - Date Code</p>   |

Note: ANPEC lead-free products contain molding compounds/die attach materials and 100% matte tin plate termination finish; which are fully compliant with RoHS. ANPEC lead-free products meet or exceed the lead-free requirements of IPC/JEDEC J-STD-020C for MSL classification at lead-free peak reflow temperature. ANPEC defines "Green" to mean lead-free (RoHS compliant) and halogen free (Br or Cl does not exceed 900ppm by weight in homogeneous material and total of Br and Cl does not exceed 1500ppm by weight).

ANPEC reserves the right to make changes to improve reliability or manufacturability without notice, and advise customers to obtain the latest version of relevant information to verify before placing orders.

## Absolute Maximum Ratings

| Symbol   | Parameter                                       | Rating                  | Unit               |   |
|--|---|-------------------------|--------------------|---|
| <b>Common Ratings</b> ( $T_A=25^\circ\text{C}$ Unless Otherwise Noted) |   |                         |                    |   |
| $V_{DSS}$  | Drain-Source Voltage                            | 25                      | V                  |   |
| $V_{GSS}$  | Gate-Source Voltage                             | $\pm 20$                |                    |   |
| $T_J$  | Maximum Junction Temperature                    | 150                     | $^\circ\text{C}$   |   |
| $T_{STG}$  | Storage Temperature Range                       | -55 to 150              | $^\circ\text{C}$   |   |
| $I_S$  | Diode Continuous Forward Current                | 30                      | A                  |   |
| $I_{DP}$   | 300 $\mu\text{s}$ Pulse Drain Current Tested    | $T_C=25^\circ\text{C}$  | 120                | A |
|  |   | $T_C=100^\circ\text{C}$ | 80                 |   |
| $I_D$  | Continuous Drain Current                        | $T_C=25^\circ\text{C}$  | 50*                | A |
|  |   | $T_C=100^\circ\text{C}$ | 35                 |   |
| $P_D$  | Maximum Power Dissipation                       | $T_C=25^\circ\text{C}$  | 50                 | W |
|  |   | $T_C=100^\circ\text{C}$ | 20                 |   |
| $R_{\theta JC}$  | Thermal Resistance-Junction to Case             | 2.5                     | $^\circ\text{C/W}$ |   |
| $R_{\theta JA}$  | Thermal Resistance-Junction to Ambient          | 50                      | $^\circ\text{C/W}$ |   |
| $E_{AS}$   | Drain-Source Avalanche Energy, $L=0.5\text{mH}$ | 100                     | mJ                 |   |

Note : \* Current limited by bond wire.

## Electrical Characteristics ( $T_A=25^\circ\text{C}$ Unless Otherwise Noted)

| Symbol                        | Parameter                        | Test Conditions   | APM2518NU |      |           | Unit          |
|-------------------------------|----------------------------------|---|-----------|------|-----------|---------------|
|                               |                                  |   | Min.      | Typ. | Max.      |               |
| <b>Static Characteristics</b> |                                  |   |           |      |           |               |
| $BV_{DSS}$                    | Drain-Source Breakdown Voltage   | $V_{GS}=0\text{V}, I_{DS}=250\mu\text{A}$                       | 25        | -    | -         | V             |
| $I_{DSS}$                     | Zero Gate Voltage Drain Current  | $V_{DS}=20\text{V}, V_{GS}=0\text{V}$<br>$T_J=85^\circ\text{C}$ | -         | -    | 1         | $\mu\text{A}$ |
|                               |                                  |   | -         | -    | 30        |               |
| $V_{GS(th)}$                  | Gate Threshold Voltage           | $V_{DS}=V_{GS}, I_{DS}=250\mu\text{A}$                          | 1.3       | 1.8  | 2.5       | V             |
| $I_{GSS}$                     | Gate Leakage Current             | $V_{GS}=\pm 20\text{V}, V_{DS}=0\text{V}$                       | -         | -    | $\pm 100$ | nA            |
| $R_{DS(ON)}^a$                | Drain-Source On-state Resistance | $V_{GS}=10\text{V}, I_{DS}=30\text{A}$                          | -         | 8    | 9.5       | m $\Omega$    |
|                               |                                  | $V_{GS}=4.5\text{V}, I_{DS}=15\text{A}$                         | -         | 15   | 20        |               |
| <b>Diode Characteristics</b>  |                                  |   |           |      |           |               |
| $V_{SD}^a$                    | Diode Forward Voltage            | $I_{SD}=15\text{A}, V_{GS}=0\text{V}$                           | -         | 0.8  | 1.1       | V             |
| $t_{rr}$                      | Reverse Recovery Time            | $I_{DS}=30\text{A}, di_{SD}/dt=100\text{A}/\mu\text{s}$         | -         | 24   | -         | ns            |
| $Q_{rr}$                      | Reverse Recovery Charge          |   | -         | 16   | -         | nC            |

## Electrical Characteristics (Cont.) (T<sub>A</sub>=25°C Unless Otherwise Noted)

| Symbol  | Parameter                    | Test Conditions   | APM2518NU |      |      | Unit |
|---|------------------------------|---|-----------|------|------|------|
|   |                              |   | Min.      | Typ. | Max. |      |
| <b>Dynamic Characteristics <sup>b</sup></b>     |                              |   |           |      |      |      |
| R <sub>G</sub>                                  | Gate Resistance              | V <sub>GS</sub> =0V, V <sub>DS</sub> =0V, F=1MHz  | -         | 2.5  | -    | Ω    |
| C <sub>iss</sub>                                | Input Capacitance            | V <sub>GS</sub> =0V,<br>V <sub>DS</sub> =15V,<br>Frequency=1.0MHz   | -         | 1080 | -    | pF   |
| C <sub>oss</sub>                                | Output Capacitance           |   | -         | 200  | -    |      |
| C <sub>rss</sub>                                | Reverse Transfer Capacitance |   | -         | 170  | -    |      |
| t <sub>d(ON)</sub>                              | Turn-on Delay Time           | V <sub>DD</sub> =15V, R <sub>L</sub> =15Ω,<br>I <sub>DS</sub> =1A, V <sub>GEN</sub> =10V,<br>R <sub>G</sub> =6Ω | -         | 12   | 22   | ns   |
| t <sub>r</sub>                                  | Turn-on Rise Time            |   | -         | 11   | 21   |      |
| t <sub>d(OFF)</sub>                             | Turn-off Delay Time          |   | -         | 35   | 64   |      |
| t <sub>f</sub>                                  | Turn-off Fall Time           |   | -         | 17   | 32   |      |
| <b>Gate Charge Characteristics <sup>b</sup></b> |                              |   |           |      |      |      |
| Q <sub>g</sub>                                  | Total Gate Charge            | V <sub>DS</sub> =15V, V <sub>GS</sub> =10V,<br>I <sub>DS</sub> =30A   | -         | 18   | 25   | nC   |
| Q <sub>gs</sub>                                 | Gate-Source Charge           |   | -         | 2.7  | -    |      |
| Q <sub>gd</sub>                                 | Gate-Drain Charge            |   | -         | 8    | -    |      |

Note a : Pulse test ; pulse width ≤ 300μs, duty cycle ≤ 2%.

Note b : Guaranteed by design, not subject to production testing.

### Typical Operating Characteristics

Power Dissipation

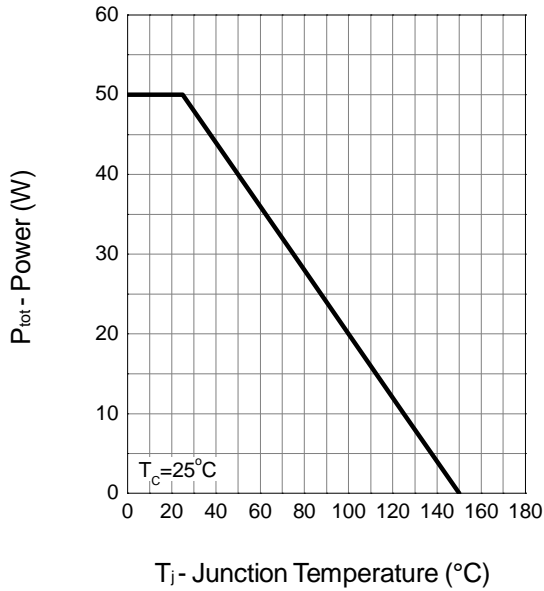

Drain Current

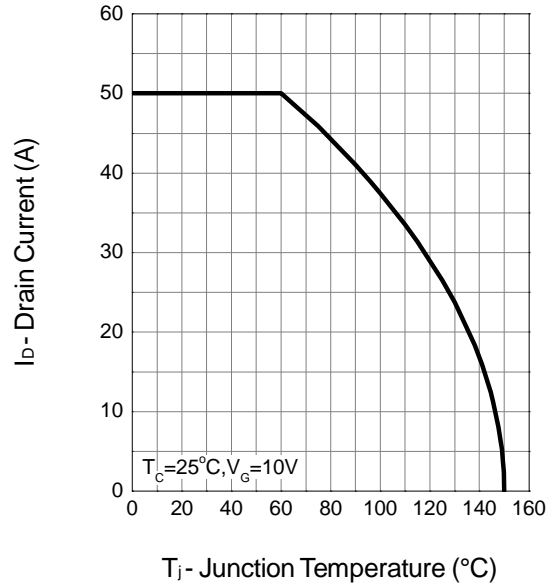

Safe Operation Area

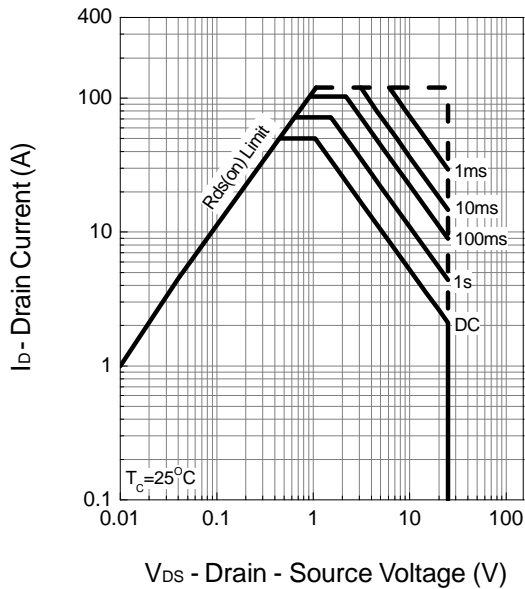

Thermal Transient Impedance

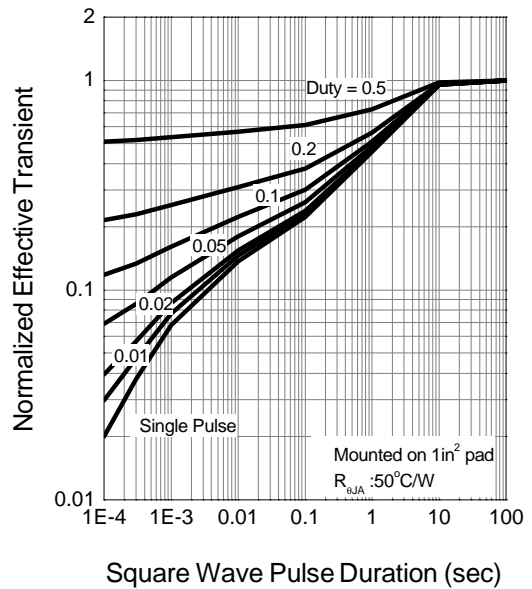

Typical Operating Characteristics (Cont.)

Output Characteristics

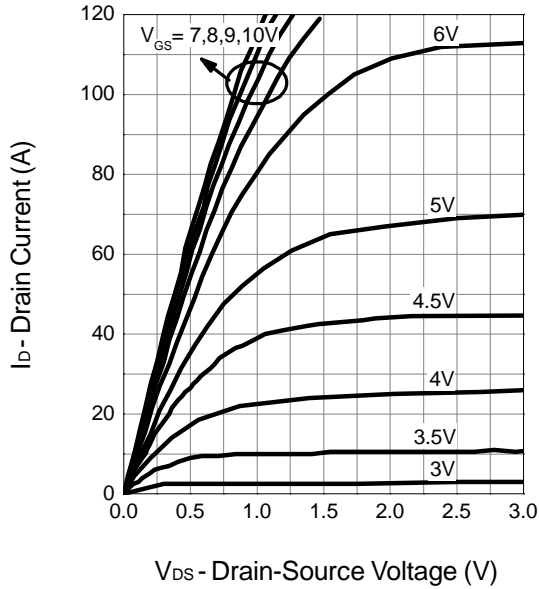

Drain-Source On Resistance

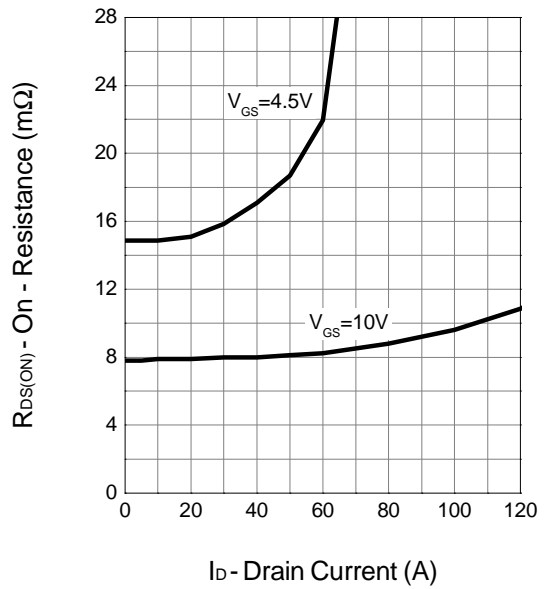

Drain-Source On Resistance

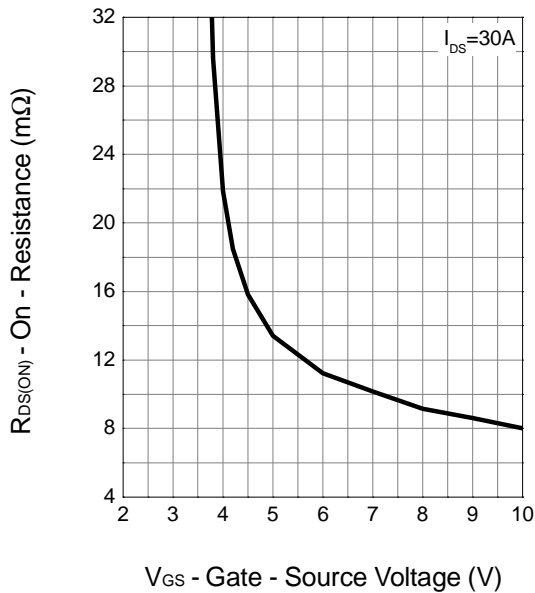

Gate Threshold Voltage

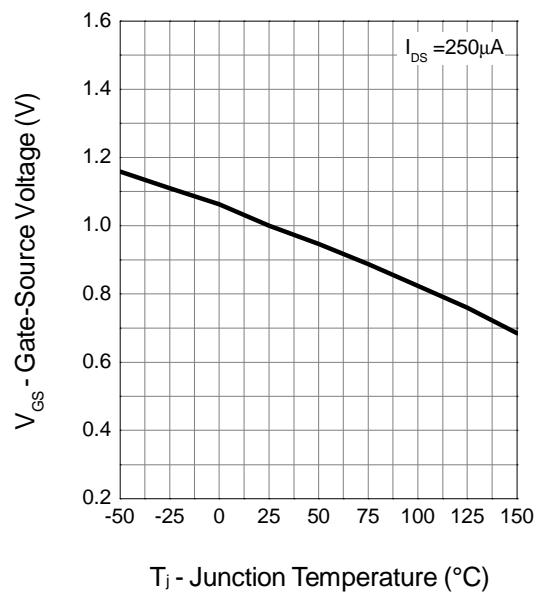

Typical Operating Characteristics (Cont.)

Drain-Source On Resistance

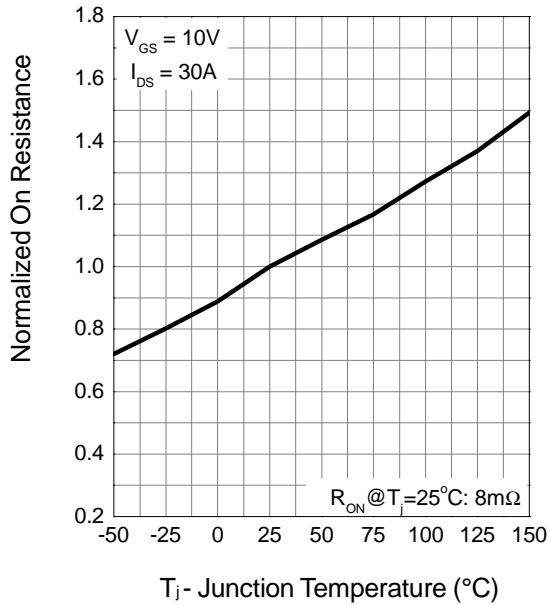

Source-Drain Diode Forward

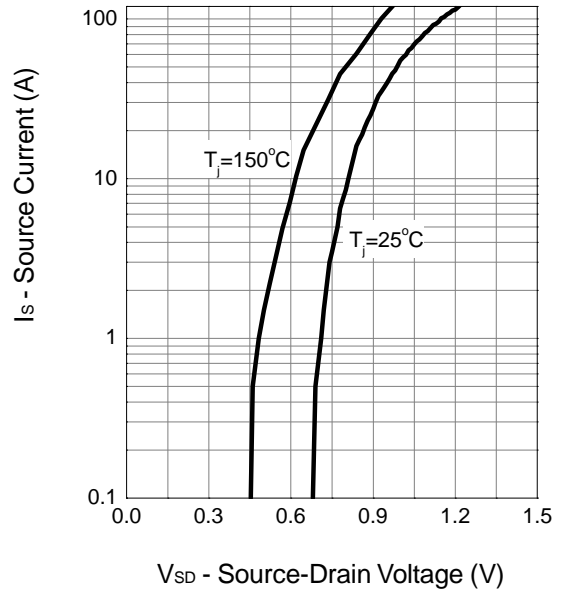

Capacitance

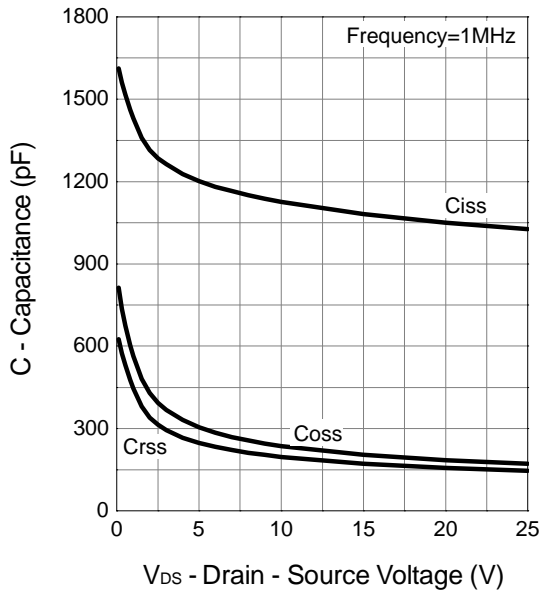

Gate Charge

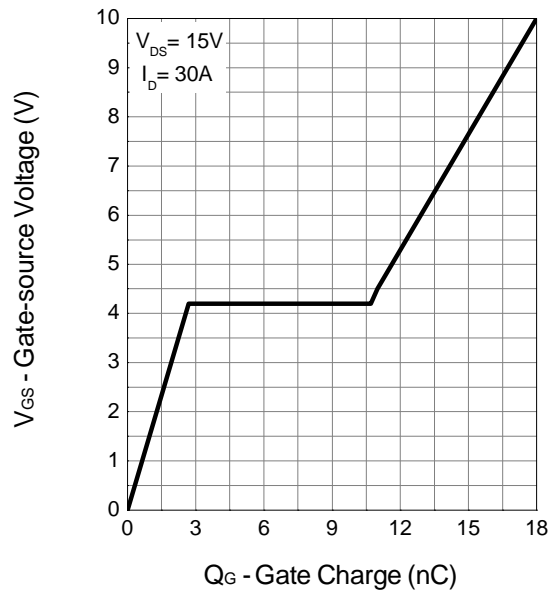

Package Information

TO-252

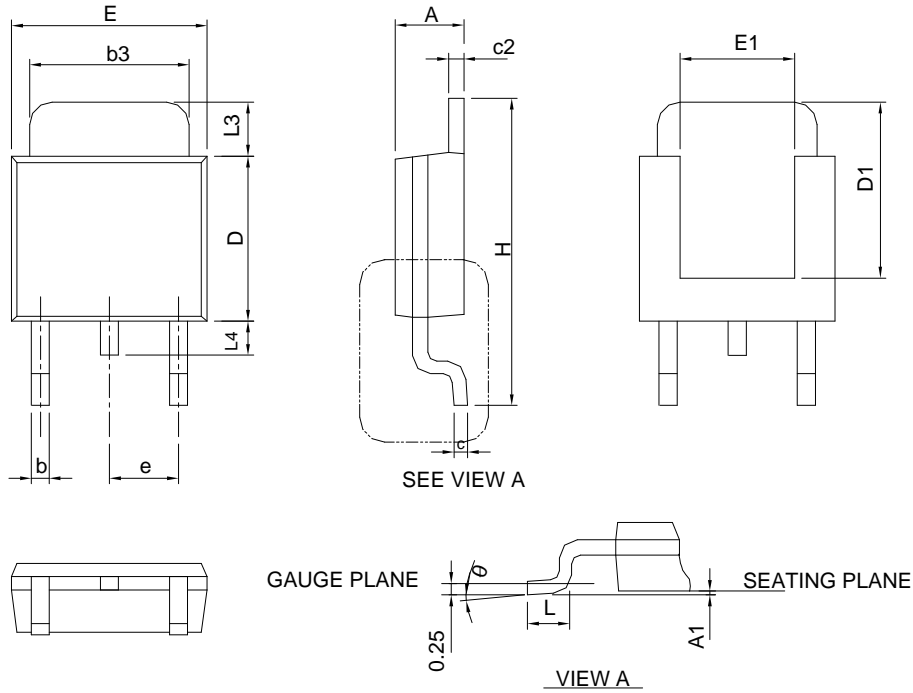

| Symbol   | TO-252      |       |           |       |
|----------|-------------|-------|-----------|-------|
|          | MILLIMETERS |       | INCHES    |       |
|          | MIN.        | MAX.  | MIN.      | MAX.  |
| A        | 2.18        | 2.39  | 0.086     | 0.094 |
| A1       |             | 0.13  |           | 0.005 |
| b        | 0.50        | 0.89  | 0.020     | 0.035 |
| b3       | 4.95        | 5.46  | 0.195     | 0.215 |
| c        | 0.46        | 0.61  | 0.018     | 0.024 |
| c2       | 0.46        | 0.89  | 0.018     | 0.035 |
| D        | 5.33        | 6.22  | 0.210     | 0.245 |
| D1       | 4.57        | 6.00  | 0.180     | 0.236 |
| E        | 6.35        | 6.73  | 0.250     | 0.265 |
| E1       | 3.81        | 6.00  | 0.150     | 0.236 |
| e        | 2.29 BSC    |       | 0.090 BSC |       |
| H        | 9.40        | 10.41 | 0.370     | 0.410 |
| L        | 0.90        | 1.78  | 0.035     | 0.070 |
| L3       | 0.89        | 2.03  | 0.035     | 0.080 |
| L4       |             | 1.02  |           | 0.040 |
| $\theta$ | 0°          | 8°    | 0°        | 8°    |

Note : Follow JEDEC TO-252 .

### Carrier Tape & Reel Dimensions

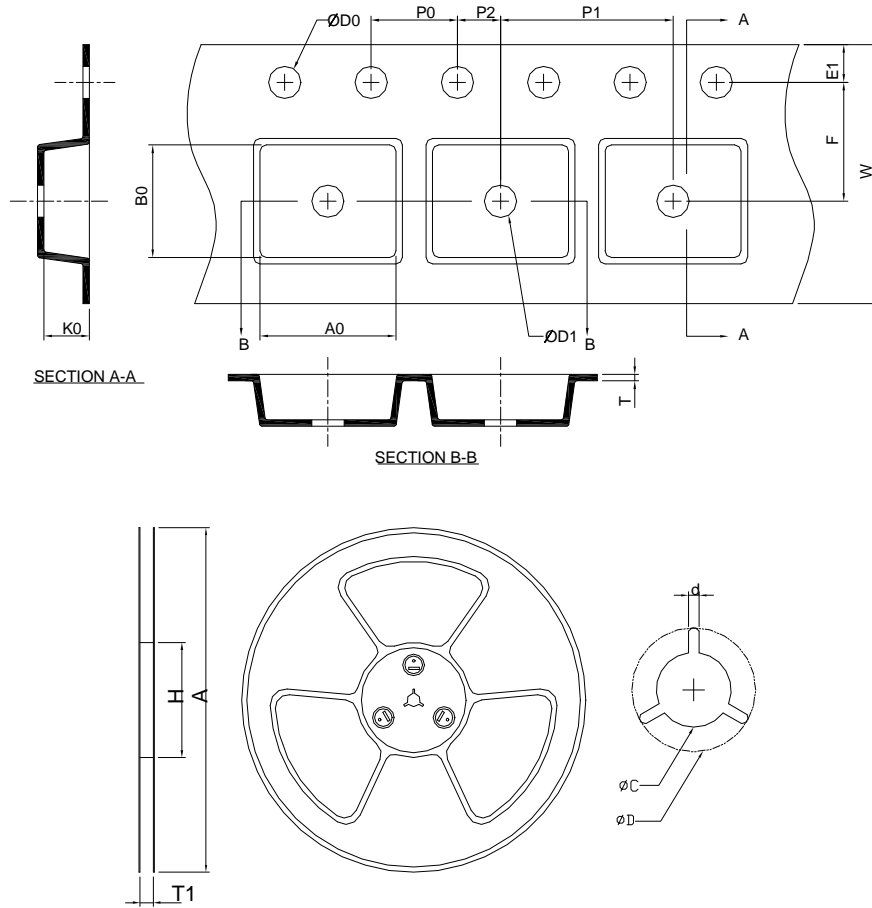

| Application | A           | H         | T1                 | C                  | d         | D                 | W          | E1          | F          |
|-------------|-------------|-----------|--------------------|--------------------|-----------|-------------------|------------|-------------|------------|
| TO-252      | 330.0 ±0.00 | 50 MIN.   | 16.4+2.00<br>-0.00 | 13.0+0.50<br>-0.20 | 1.5 MIN.  | 20.2 MIN.         | 16.0 ±0.30 | 1.75 ±0.10  | 7.50 ±0.05 |
|             | <b>P0</b>   | <b>P1</b> | <b>P2</b>          | <b>D0</b>          | <b>D1</b> | <b>T</b>          | <b>A0</b>  | <b>B0</b>   | <b>K0</b>  |
|             | 4.0 ±0.10   | 8.0 ±0.10 | 2.0 ±0.05          | 1.5+0.10<br>-0.00  | 1.5 MIN.  | 0.6+0.00<br>-0.40 | 6.80 ±0.20 | 10.40 ±0.20 | 2.50 ±0.20 |

(mm)

### Devices Per Unit

| Package Type | Unit        | Quantity |
|--------------|-------------|----------|
| TO-252       | Tape & Reel | 2500     |



## Taping Direction Information

TO-252

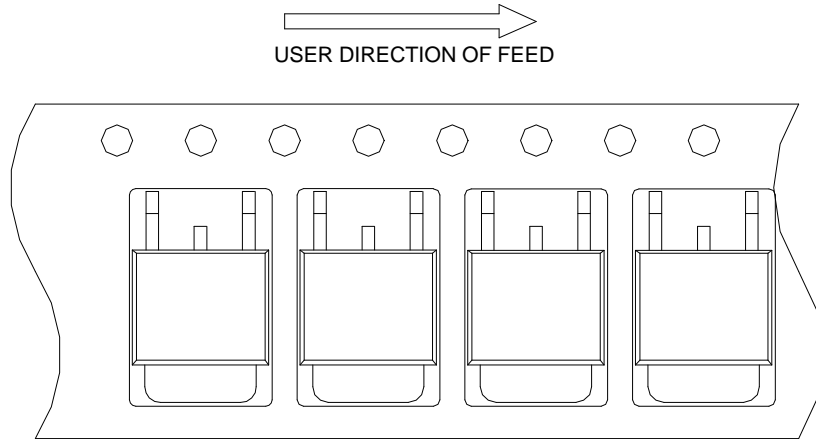

## Reflow Condition (IR/Convection or VPR Reflow)

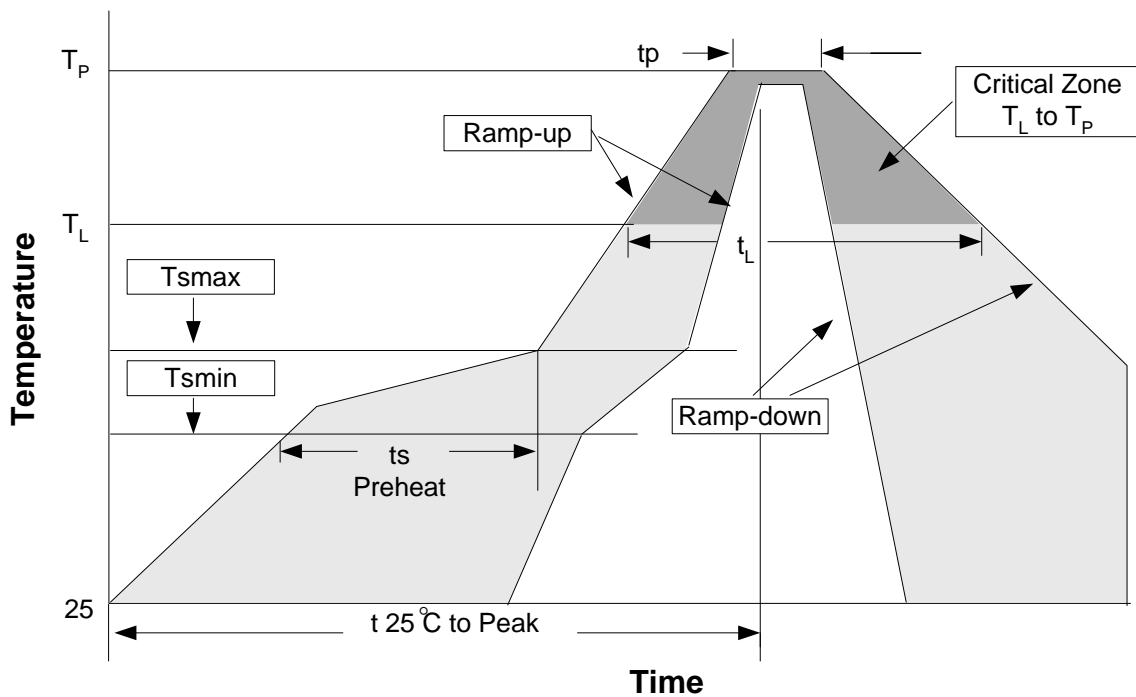

## Reliability Test Program

| Test item     | Method              | Description             |
|---------------|---------------------|-------------------------|
| SOLDERABILITY | MIL-STD-883D-2003   | 245°C, 5 sec            |
| HOLT          | MIL-STD-883D-1005.7 | 1000 Hrs Bias @125°C    |
| PCT           | JESD-22-B, A102     | 168 Hrs, 100%RH, 121°C  |
| TST           | MIL-STD-883D-1011.9 | -65°C~150°C, 200 Cycles |

## Classification Reflow Profiles

| Profile Feature  | Sn-Pb Eutectic Assembly          | Pb-Free Assembly                 |
|--|----------------------------------|----------------------------------|
| Average ramp-up rate (T <sub>L</sub> to T <sub>P</sub> )   | 3°C/second max.                  | 3°C/second max.                  |
| Preheat<br>- Temperature Min (T <sub>smin</sub> )<br>- Temperature Max (T <sub>smax</sub> )<br>- Time (min to max) (t <sub>s</sub> ) | 100°C<br>150°C<br>60-120 seconds | 150°C<br>200°C<br>60-180 seconds |
| Time maintained above:<br>- Temperature (T <sub>L</sub> )<br>- Time (t <sub>L</sub> )  | 183°C<br>60-150 seconds          | 217°C<br>60-150 seconds          |
| Peak/Classification Temperature (T <sub>p</sub> )  | See table 1                      | See table 2                      |
| Time within 5°C of actual Peak Temperature (t <sub>p</sub> )   | 10-30 seconds                    | 20-40 seconds                    |
| Ramp-down Rate   | 6°C/second max.                  | 6°C/second max.                  |
| Time 25°C to Peak Temperature  | 6 minutes max.                   | 8 minutes max.                   |

Note: All temperatures refer to topside of the package. Measured on the body surface.

Table 1. SnPb Eutectic Process – Package Peak Reflow Temperatures

| Package Thickness | Volume mm <sup>3</sup><br><350 | Volume mm <sup>3</sup><br>≈350 |
|-------------------|--------------------------------|--------------------------------|
| <2.5 mm           | 240 +0/-5°C                    | 225 +0/-5°C                    |
| ≥2.5 mm           | 225 +0/-5°C                    | 225 +0/-5°C                    |

Table 2. Pb-free Process – Package Classification Reflow Temperatures

| Package Thickness | Volume mm <sup>3</sup><br><350 | Volume mm <sup>3</sup><br>350-2000 | Volume mm <sup>3</sup><br>>2000 |
|-------------------|--------------------------------|------------------------------------|---------------------------------|
| <1.6 mm           | 260 +0°C*                      | 260 +0°C*                          | 260 +0°C*                       |
| 1.6 mm – 2.5 mm   | 260 +0°C*                      | 250 +0°C*                          | 245 +0°C*                       |
| ≥2.5 mm           | 250 +0°C*                      | 245 +0°C*                          | 245 +0°C*                       |

\*Tolerance: The device manufacturer/supplier **shall** assure process compatibility up to and including the stated classification temperature (this means Peak reflow temperature +0°C. For example 260°C+0°C) at the rated MSL level.

## Customer Service

### Anpec Electronics Corp.

Head Office :

No.6, Dusing 1st Road, SBIP,

Hsin-Chu, Taiwan, R.O.C.

Tel : 886-3-5642000

Fax : 886-3-5642050

Taipei Branch :

2F, No. 11, Lane 218, Sec 2 Jhongsing Rd.,

Sindain City, Taipei County 23146, Taiwan

Tel : 886-2-2910-3838

Fax : 886-2-2917-3838