

## N-Channel Enhancement Mode MOSFET

### Features

- 30V / 80A ,  $R_{DS(ON)} = 4m\Omega(\text{typ.}) @ V_{GS} = 10V$   
 $R_{DS(ON)} = 7m\Omega(\text{typ.}) @ V_{GS} = 4.5V$
- Super High Dense Advanced Cell Design for Extremely Low  $R_{DS(ON)}$
- Reliable and Rugged
- TO-220, TO-252 and TO-263 Packages

### Pin Description

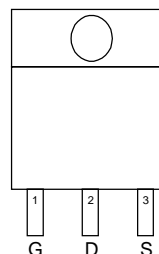

Top View of TO-220, TO-252 and TO-263

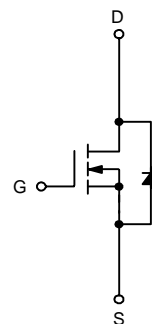

### Applications

- Power Management in Desktop Computer or DC/DC Converters.

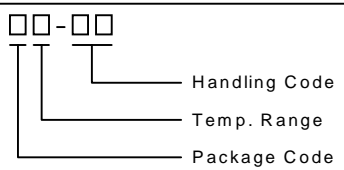

N-Channel MOSFET

### Ordering and Marking Information

<p>APM3005N    □□-□□</p>  <p>Handling Code Temp. Range Package Code</p>	<p>Package Code F : TO-220    U : TO-252    G : TO-263 Operating Junction Temp. Range C : -55 to 125 °C Handling Code TU : Tube TR : Tape &amp; Reel</p>
<p>APM3005N :    </p>	<p>XXXXX - Date Code</p>

### Absolute Maximum Ratings ( $T_A = 25^\circ\text{C}$ unless otherwise noted)

Symbol	Parameter	Rating	Unit
$V_{DSS}$	Drain-Source Voltage	30	V
$V_{GSS}$	Gate-Source Voltage	$\pm 20$	
$I_D^*$	Maximum Drain Current – Continuous	80	A
$I_{DM}$	Maximum Drain Current – Pulsed	160	

ANPEC reserves the right to make changes to improve reliability or manufacturability without notice, and advise customers to obtain the latest version of relevant information to verify before placing orders.

**Absolute Maximum Ratings (Cont.)** ( $T_A = 25^\circ\text{C}$  unless otherwise noted)

Symbol	Parameter	Rating	Unit		
$P_D$	Maximum Power Dissipation	$T_A=25^\circ\text{C}$	TO-252	50	W
			TO-263	62.5	
		$T_A=100^\circ\text{C}$	TO-252	20	W
			TO-263	25	
$T_J, T_{STG}$	Maximum Operating and Storage Junction Temperature	-55 to 150	$^\circ\text{C}$		
$R_{\theta JA}$	Thermal Resistance – Junction to Ambient	TO-252	50	$^\circ\text{C}/\text{W}$	
		TO-263	60		
$R_{\theta JC}$	Thermal Resistance – Junction to Case	TO-252	2.5	$^\circ\text{C}/\text{W}$	
		TO-263	2		

\* Surface Mounted on FR4 Board,  $t \leq 10$  sec.

**Electrical Characteristics** ( $T_A = 25^\circ\text{C}$  unless otherwise noted)

Symbol	Parameter	Test Condition	APM3005N			Unit
			Min.	Typ.	Max.	
<b>Static</b>						
$BV_{DSS}$	Drain-Source Breakdown Voltage	$V_{GS}=0V, I_{DS}=250\mu\text{A}$	30			V
$I_{DSS}$	Zero Gate Voltage Drain Current	$V_{DS}=24V, V_{GS}=0V$			1	$\mu\text{A}$
$V_{GS(th)}$	Gate Threshold Voltage	$V_{DS}=V_{GS}, I_{DS}=250\mu\text{A}$	1	1.5	2	V
$I_{GSS}$	Gate Leakage Current	$V_{GS}=\pm 20V, V_{DS}=0V$			$\pm 100$	nA
$R_{DS(ON)}^a$	Drain-Source On-state Resistance	$V_{GS}=10V, I_{DS}=80A$		4	5.4	m $\Omega$
		$V_{GS}=4.5V, I_{DS}=70A$		7	8	
$V_{SD}^a$	Diode Forward Voltage	$I_{SD}=30A, V_{GS}=0V$		0.85	1.3	V
<b>Dynamic<sup>b</sup></b>						
$Q_g$	Total Gate Charge	$V_{DS}=15V, I_{DS}=80A$		28	32	nC
$Q_{gs}$	Gate-Source Charge	$V_{GS}=5V,$		12.8		
$Q_{gd}$	Gate-Drain Charge			21.2		
$t_{d(ON)}$	Turn-on Delay Time			13	20	ns
$T_r$	Turn-on Rise Time	$V_{DD}=15V, I_{DS}=1A,$		9	15	
$t_{d(OFF)}$	Turn-off Delay Time	$V_{GEN}=10V, R_G=0.2\Omega$		43	66	
$T_f$	Turn-off Fall Time			14	28	
$C_{iss}$	Input Capacitance	$V_{GS}=0V$		4700		pF
$C_{oss}$	Output Capacitance	$V_{DS}=15V$		930		
$C_{rss}$	Reverse Transfer Capacitance	Frequency=1.0MHz		280		

**Notes**

<sup>a</sup> : Pulse test ; pulse width  $\leq 300\mu\text{s}$ , duty cycle  $\leq 2\%$

<sup>b</sup> : Guaranteed by design, not subject to production testing

## Typical Characteristics

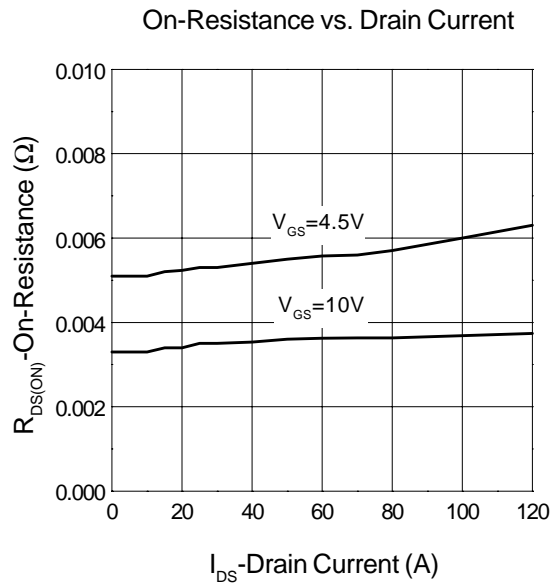
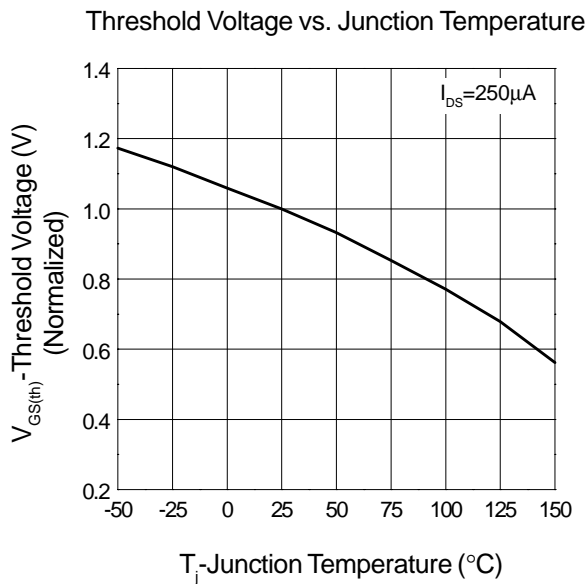
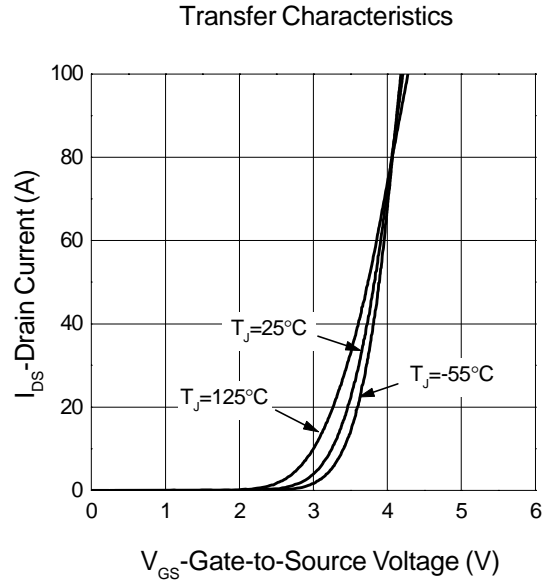
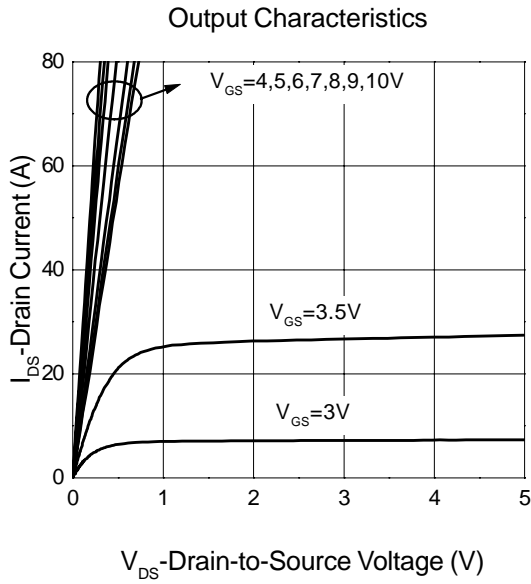

Typical Characteristics (Cont.)

On-Resistance vs. Gate-to-Source Voltage

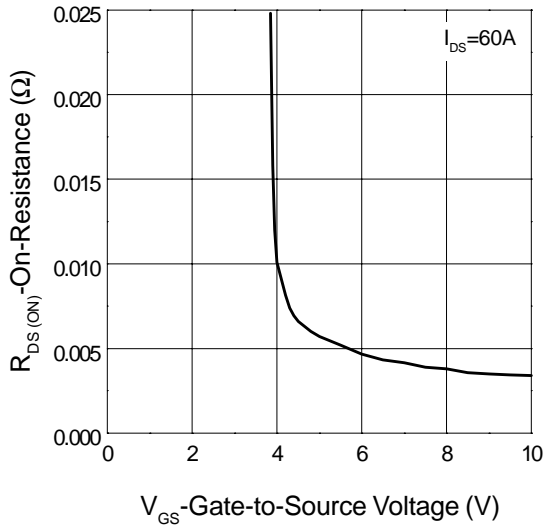

On-Resistance vs. Junction Temperature

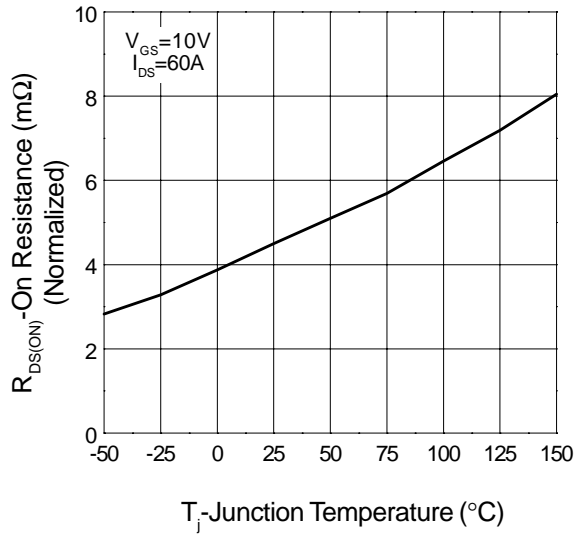

On-Resistance vs. Junction Temperature

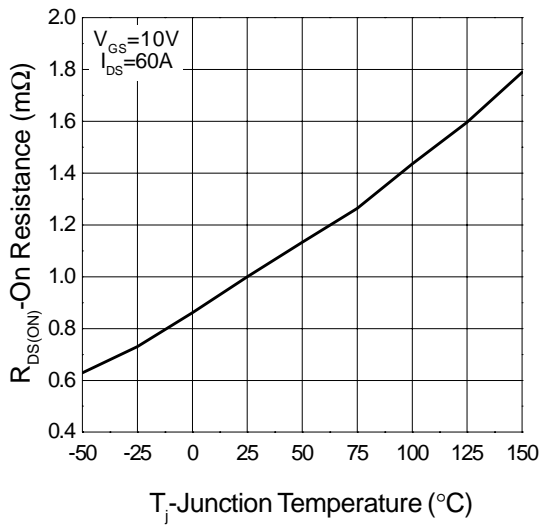

Gate Charge

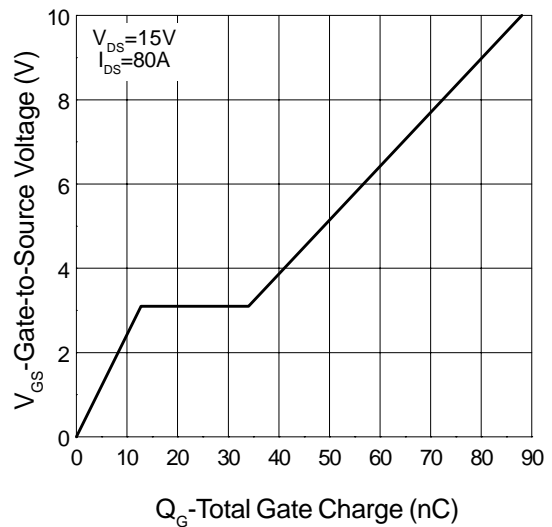

Typical Characteristics (Cont.)

Capacitance Characteristics

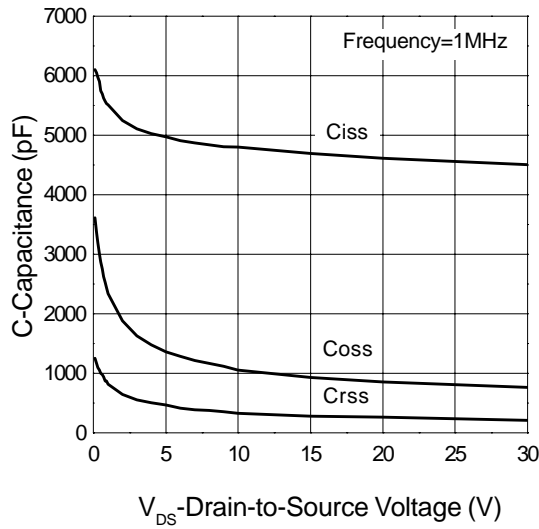

Source-Drain Diode Forward Voltage

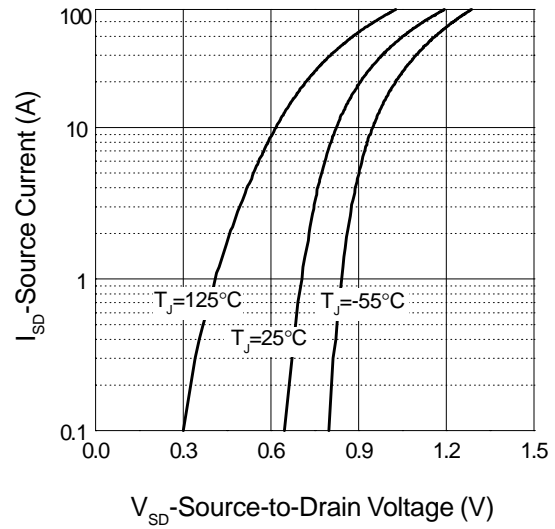

Single Pulse Power TO-252

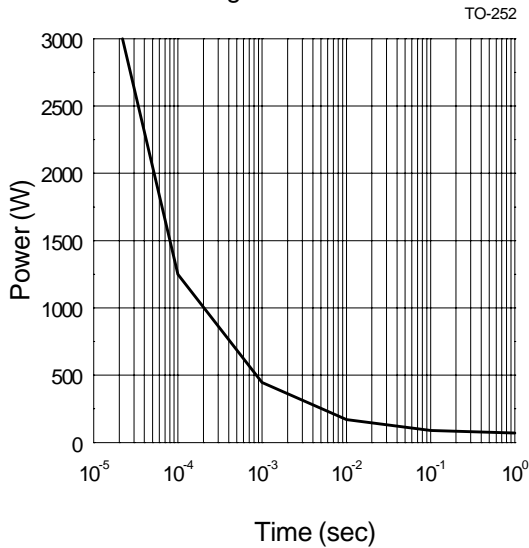

Single Pulse Power TO-263

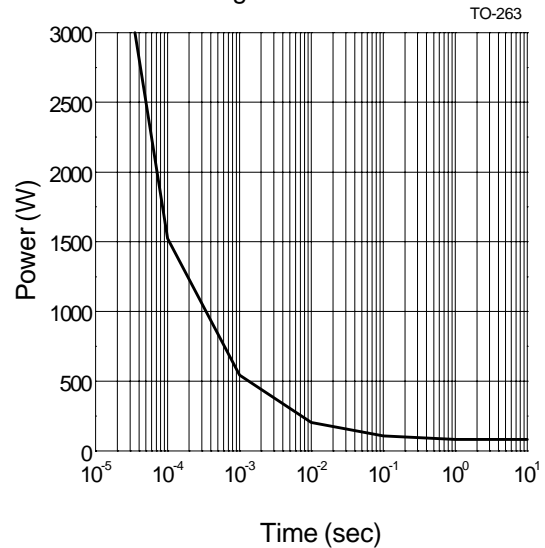

Typical Characteristics (Cont.)

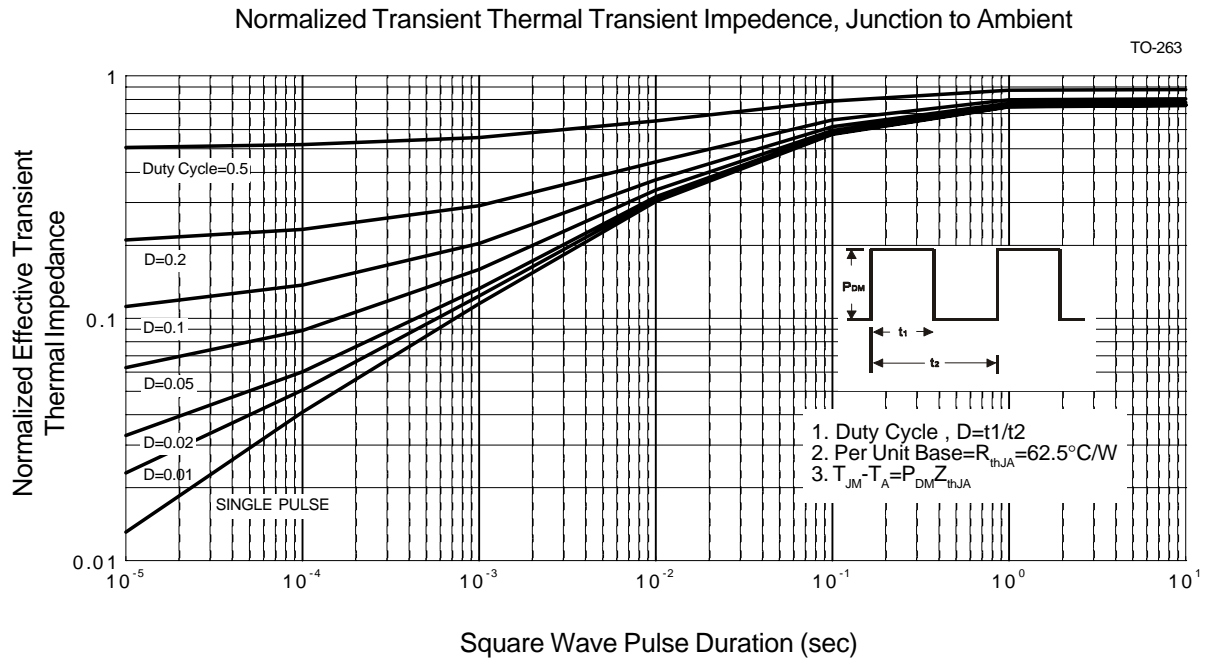
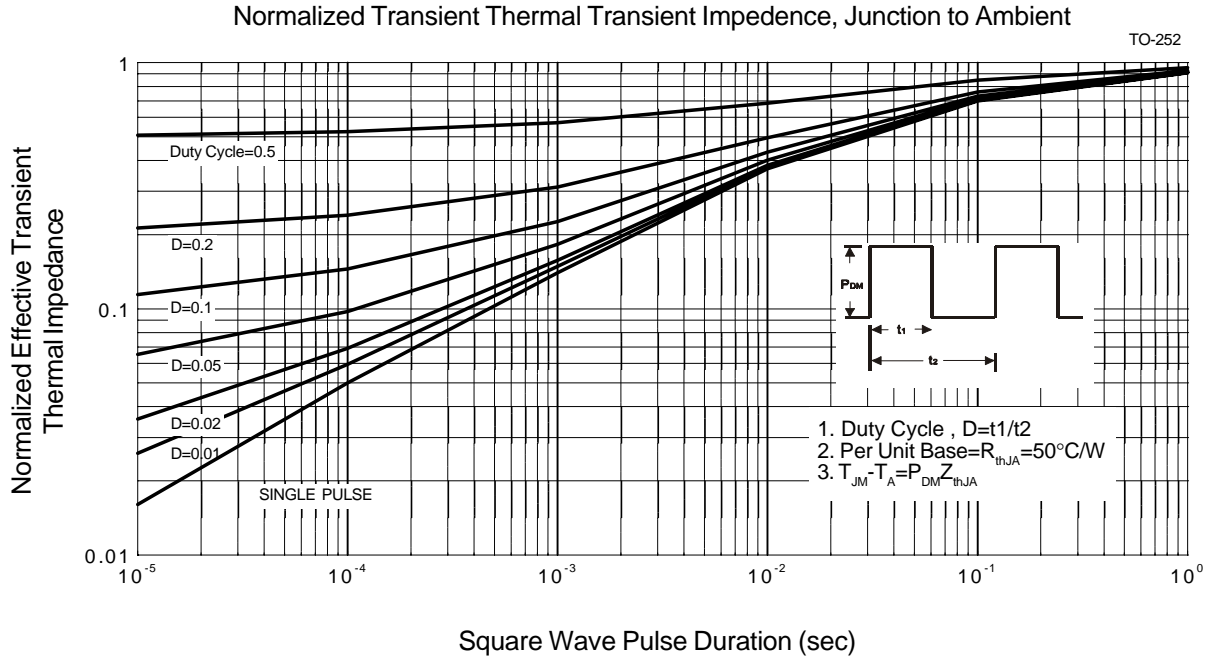

## Package Information

TO-220 ( Reference JEDEC Registration TO-220)

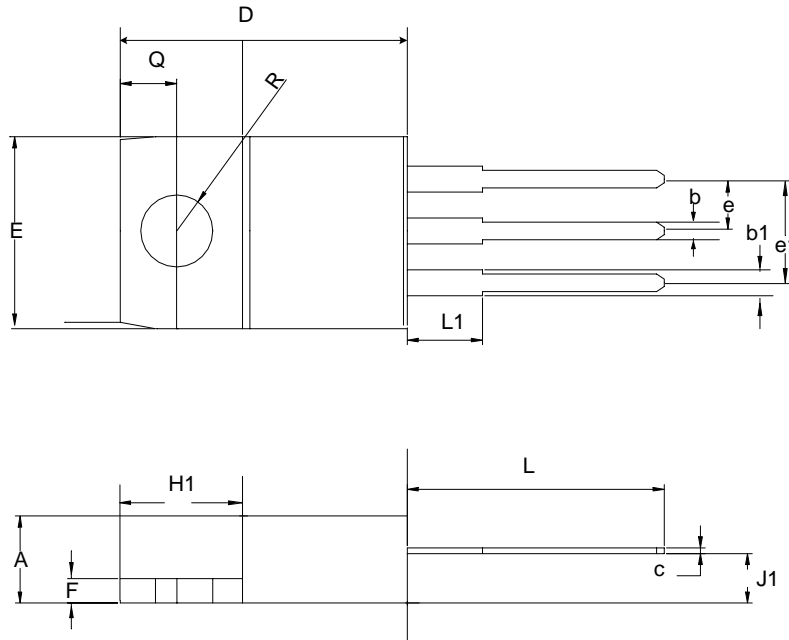

Dim	Millimeters		Inches	
	Min.	Max.	Min.	Max.
A	3.56	4.83	0.140	0.190
b1	1.14	1.78	0.045	0.070
b	0.51	1.14	0.020	0.045
c	0.31	1.14	0.012	0.045
D	14.23	16.51	0.560	0.650
e	2.29	2.79	0.090	0.110
e1	4.83	5.33	0.190	0.210
E	9.65	10.67	0.380	0.420
F	0.51	1.40	0.020	0.055
H1	5.84	6.86	0.230	0.270
J1	2.03	2.92	0.080	0.115
L	12.7	14.73	0.500	0.580
L1	3.65	6.35	0.143	0.250
R	3.53	4.09	0.139	0.161
Q	2.54	3.43	0.100	0.135

Package Information (Cont.)

TO-252( Reference JEDEC Registration TO-252)

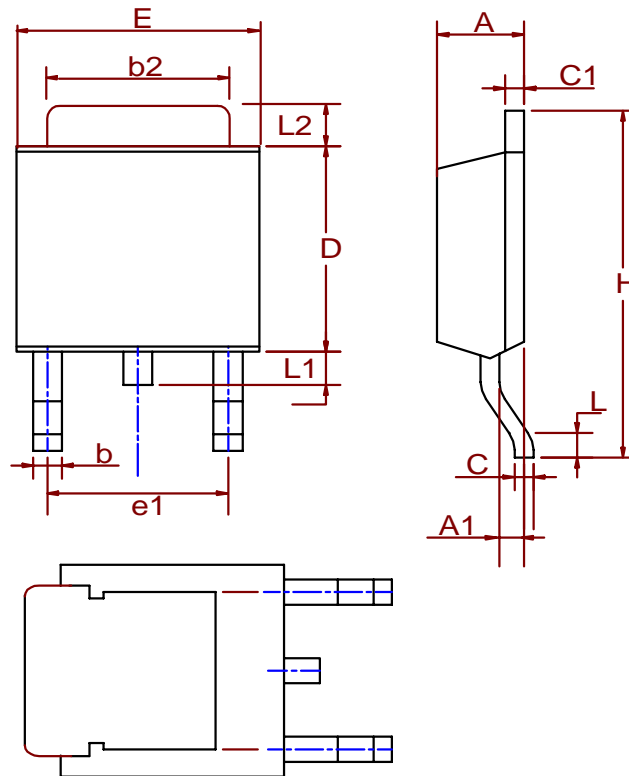

Dim	Millimeters		Inches	
	Min.	Max.	Min.	Max.
A	2.18	2.39	0.086	0.094
A1	0.89	1.27	0.035	0.050
b	0.508	0.89	0.020	0.035
b2	5.207	5.461	0.205	0.215
C	0.46	0.58	0.018	0.023
C1	0.46	0.58	0.018	0.023
D	5.334	6.22	0.210	0.245
E	6.35	6.73	0.250	0.265
e1	3.96	5.18	0.156	0.204
H	9.398	10.41	0.370	0.410
L	0.51		0.020	
L1	0.64	1.02	0.025	0.040
L2	0.89	2.032	0.035	0.080



Package Information (Cont.)

TO-263 ( Reference JEDEC Registration TO-263)

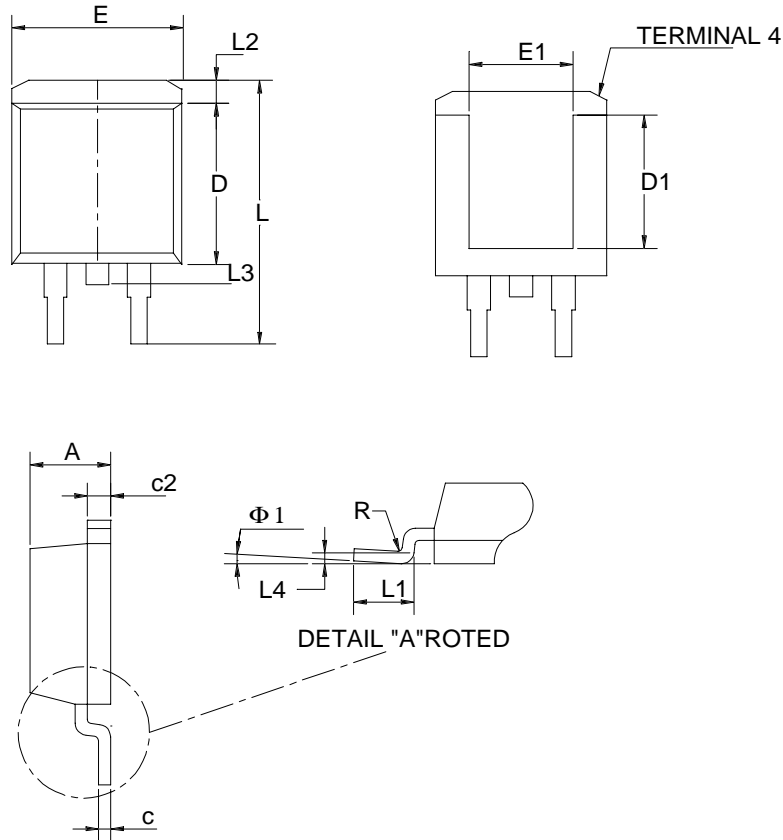

Dim	Millimeters		Inches	
	Min.	Max.	Min.	Max.
A	4.06	4.83	0.160	0.190
b	0.51	1.016	0.02	0.040
b2	1.14	1.651	0.045	0.065
c	0.38 TYP.		0.015 TYP.	
c2	1.14	1.40	0.045	0.055
D	8.64	9.65	0.340	0.380
E	9.65	10.54	0.380	0.415
L	14.60	15.88	0.575	0.625
L1	2.24	2.84	0.090	0.110
L2	1.02	2.92	0.040	0.112
L3	1.20	1.78	0.050	0.070

## Physical Specifications

Terminal Material	Solder-Plated Copper (Solder Material : 90/10 or 63/37 SnPb)
Lead Solderability	Meets EIA Specification RS186-91, ANSI/J-STD-002 Category 3.

### Reflow Condition (IR/Convection or VPR Reflow)

Reference JEDEC Standard J-STD-020A APRIL 1999

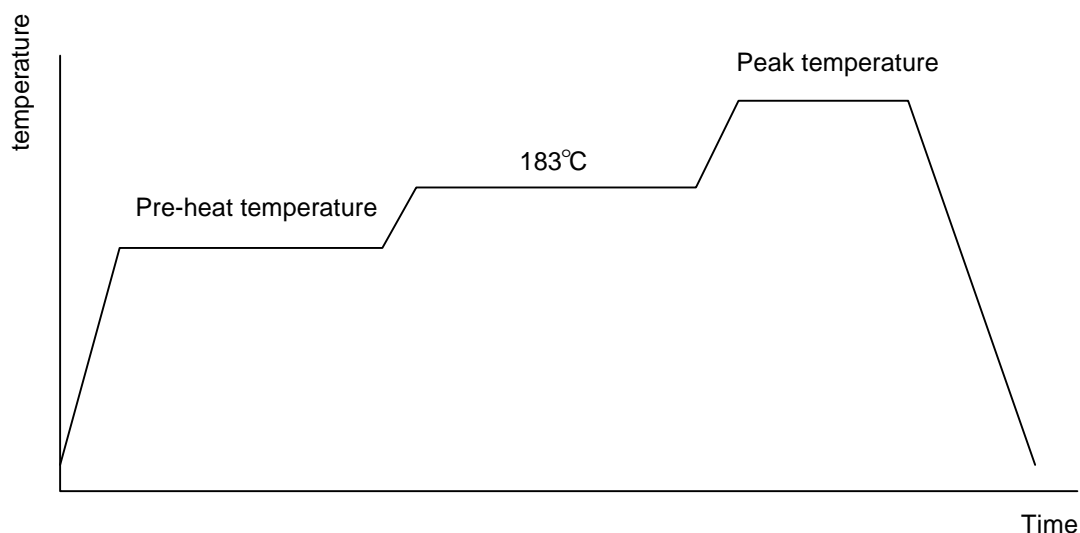

### Classification Reflow Profiles

	Convection or IR/ Convection	VPR
Average ramp-up rate(183 °C to Peak)	3 °C/second max.	10 °C /second max.
Preheat temperature 125 ± 25 °C)	120 seconds max.	
Temperature maintained above 183 °C	60 ~ 150 seconds	
Time within 5 °C of actual peak temperature	10 ~ 20 seconds	60 seconds
Peak temperature range	220 +5/-0 °C or 235 +5/-0 °C	215~ 219 °C or 235 +5/-0 °C
Ramp-down rate	6 °C /second max.	10 °C /second max.
Time 25 °C to peak temperature	6 minutes max.	

### Package Reflow Conditions

pkg. thickness ≥ 2.5mm and all bags	pkg. thickness < 2.5mm and pkg. volume ≥ 350 mm	pkg. thickness < 2.5mm and pkg. volume <
Convection 220 +5/-0 °C		Convection 235 +5/-0 °C
VPR 215-219 °C		VPR 235 +5/-0 °C
IR/Convection 220 +5/-0 °C		IR/Convection 235 +5/-0 °C

## Reliability test program

Test item	Method	Description
SOLDERABILITY	MIL-STD-883D-2003	245°C, 5 SEC
HOLT	MIL-STD 883D-1005.7	1000 Hrs Bias @ 125°C
PCT	JESD-22-B, A102	168 Hrs, 100% RH, 121°C
TST	MIL-STD 883D-1011.9	-65°C ~ 150°C, 200 Cycles

## Carrier Tape & Reel Dimension

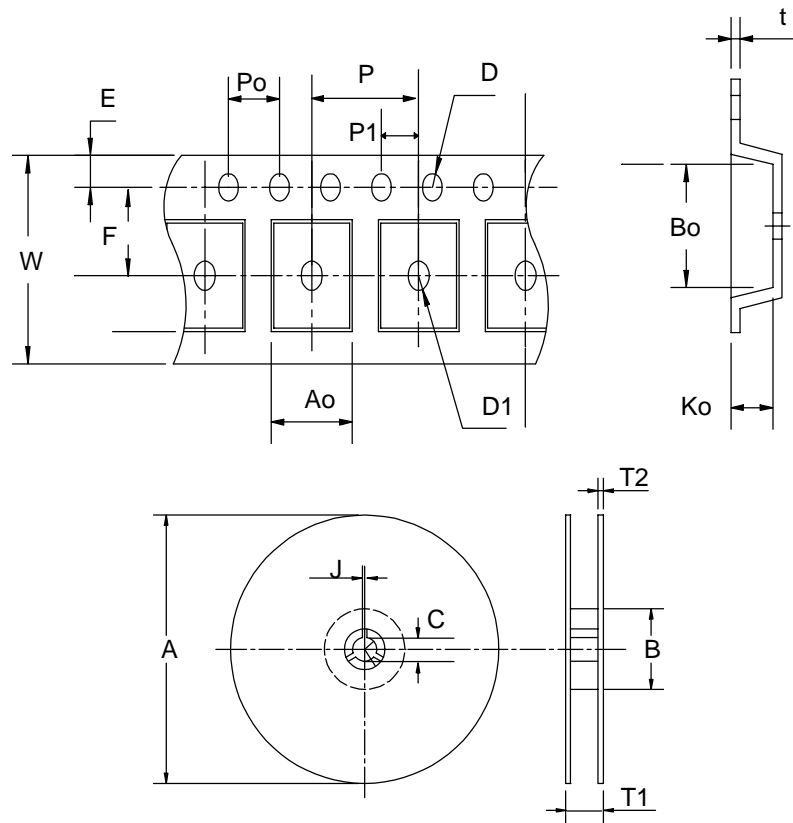

Application	A	B	C	J	T1	T2	W	P	E
TO-252	330 ± 3	100 ± 2	13 ± 0.5	2 ± 0.5	16.4 +0.3 -0.2	2.5 ± 0.5	16 +0.3 -0.1	8 ± 0.1	1.75 ± 0.1
	F	D	D1	Po	P1	Ao	Bo	Ko	t
	7.5 ± 0.1	1.5 +0.1	1.5 ± 0.25	4.0 ± 0.1	2.0 ± 0.1	6.8 ± 0.1	10.4 ± 0.1	2.5 ± 0.1	0.3 ± 0.05
Application	A	B	C	J	T1	T2	W	P	E
TO-263	380 ± 3	80 ± 2	13 ± 0.5	2 ± 0.5	24 ± 4	2 ± 0.3	24 +0.3 -0.1	16 ± 0.1	1.75 ± 0.1
	F	D	D1	Po	P1	Ao	Bo	Ko	t
	11.5 ± 0.1	1.5 +0.1	1.5 ± 0.25	4.0 ± 0.1	2.0 ± 0.1	10.8 ± 0.1	16.1 ± 0.1	5.2 ± 0.1	0.35 ± 0.013

## Cover Tape Dimensions

Application	Carrier Width	Cover Tape Width	Devices Per Reel
TO- 252	16	13.3	2500
TO- 263	24	21.3	1000

## Customer Service

### **Anpec Electronics Corp.**

Head Office :

5F, No. 2 Li-Hsin Road, SBIP,

Hsin-Chu, Taiwan, R.O.C.

Tel : 886-3-5642000

Fax : 886-3-5642050

Taipei Branch :

7F, No. 137, Lane 235, Pac Chiao Rd.,

Hsin Tien City, Taipei Hsien, Taiwan, R. O. C.

Tel : 886-2-89191368

Fax : 886-2-89191369