

P-Channel Enhancement Mode MOSFET

### Features

- 30V/-6.1A,  $R_{DS(ON)} = 24m\Omega(\text{typ.}) @ V_{GS} = -10V$   
 $R_{DS(ON)} = 30m\Omega(\text{typ.}) @ V_{GS} = -4.5V$
- Super High Density Cell Design
- Reliable and Rugged
- SO-8 Package

### Pin Description

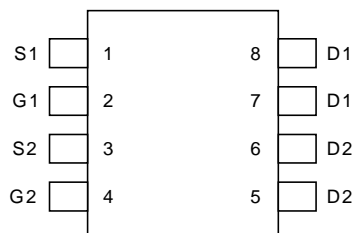

SO - 8

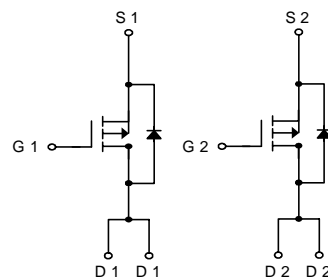

P-Channel MOSFET

### Applications

- Power Management in Notebook Computer, Portable Equipment and Battery Powered Systems

### Ordering and Marking Information

<p>APM4925 <span style="border: 1px solid black; padding: 2px;">□□-□□</span></p> <p style="margin-left: 20px;"> <span style="border: 1px solid black; padding: 2px;">□□</span> Handling Code  <span style="border: 1px solid black; padding: 2px;">□□</span> Temp. Range  <span style="border: 1px solid black; padding: 2px;">□□</span> Package Code         </p>	<p>Package Code K : SO-8</p> <p>Operation Junction Temp. Range C : -55 to 150°C</p> <p>Handling Code TU : Tube TR : Tape &amp; Reel</p>
<p>APM4925 <span style="border: 1px solid black; padding: 2px;">APM4925 XXXXXX</span></p>	<p>XXXXXX - Date Code</p>

### Absolute Maximum Ratings ( $T_A = 25^\circ\text{C}$ unless otherwise noted)

Symbol	Parameter	Rating	Unit
$V_{DSS}$	Drain-Source Voltage	-30	V
$V_{GSS}$	Gate-Source Voltage	$\pm 25$	
$I_D^*$	Maximum Drain Current – Continuous	-6.1	A
$I_{DM}$	Maximum Drain Current – Pulsed	-40	

\*Surface Mounted on FR4 Board,  $t \leq 10$  sec.

ANPEC reserves the right to make changes to improve reliability or manufacturability without notice, and advise customers to obtain the latest version of relevant information to verify before placing orders.

**Absolute Maximum Ratings** ( $T_A = 25^{\circ}\text{C}$  unless otherwise noted)

Symbol	Parameter	Rating	Unit
$P_D$	Maximum Power Dissipation	$T_A = 25^{\circ}\text{C}$	2.5
		$T_A = 100^{\circ}\text{C}$	1
$T_J$	Maximum Junction Temperature	150	$^{\circ}\text{C}$
$T_{\text{STG}}$	Storage Temperature Range	-55 to 150	
$R_{\theta\text{JA}}$	Thermal Resistance - Junction to Ambient	50	$^{\circ}\text{C}/\text{W}$

www.DataSheet4U.com

**Electrical Characteristics** ( $T_A=25^{\circ}\text{C}$  unless otherwise noted)

Symbol	Parameter	Test Condition	APM4925			Unit
			Min.	Typ <sup>a</sup> .	Max.	
<b>Static</b>						
$BV_{\text{DSS}}$	Drain-Source Breakdown Voltage	$V_{\text{GS}}=0\text{V}, I_D = -250\mu\text{A}$	-30			V
$I_{\text{DSS}}$	Zero Gate Voltage Drain Current	$V_{\text{DS}} = -24\text{V}, V_{\text{GS}}=0\text{V}$			-1	$\mu\text{A}$
$V_{\text{GS(th)}}$	Gate Threshold Voltage	$V_{\text{DS}}=V_{\text{GS}}, I_D = -250\mu\text{A}$	-1	-1.5	-2	V
$I_{\text{GSS}}$	Gate Leakage Current	$V_{\text{GS}} = \pm 25\text{V}, V_{\text{DS}}=0\text{V}$			$\pm 100$	nA
$R_{\text{DS(ON)}}^b$	Drain-Source On-state Resistance	$V_{\text{GS}} = -10\text{V}, I_D = -6.1\text{A}$		24	27	m $\Omega$
		$V_{\text{GS}} = -4.5\text{V}, I_D = -5.1\text{A}$		30	35	
$V_{\text{SD}}^b$	Diode Forward Voltage	$I_{\text{SD}} = -1.7\text{A}, V_{\text{GS}}=0\text{V}$		-0.7	-1.3	V
<b>Dynamic<sup>a</sup></b>						
$Q_g$	Total Gate Charge	$V_{\text{DS}} = -15\text{V}, V_{\text{GS}} = -10\text{V}, I_D = -4.6\text{A}$		48	58	nC
$Q_{\text{gs}}$	Gate-Source Charge			10		
$Q_{\text{gd}}$	Gate-Drain Charge			9		
$t_{\text{d(ON)}}$	Turn-on Delay Time	$V_{\text{DD}} = -25\text{V}, R_L = 12.5\Omega, I_D = -2\text{A}, V_{\text{GEN}} = -10\text{V}, R_G = 6\Omega,$		17	33	ns
$t_r$	Turn-on Rise Time			18	35	
$t_{\text{d(OFF)}}$	Turn-off Delay Time			70	128	
$t_f$	Turn-off Fall Time			30	56	
$C_{\text{iss}}$	Input Capacitance	$V_{\text{GS}}=0\text{V}, V_{\text{DS}} = -25\text{V}$ Frequency = 1.0MHZ		3200		pF
$C_{\text{oss}}$	Output Capacitance			560		
$C_{\text{rss}}$	Reverse Capacitance			250		

Notes

<sup>a</sup> : Guaranteed by design, not subject to production testing

<sup>b</sup> : Pulse test ; pulse width  $\leq 300\mu\text{s}$ , duty cycle  $\leq 2\%$

## Typical Characteristics

Output Characteristics

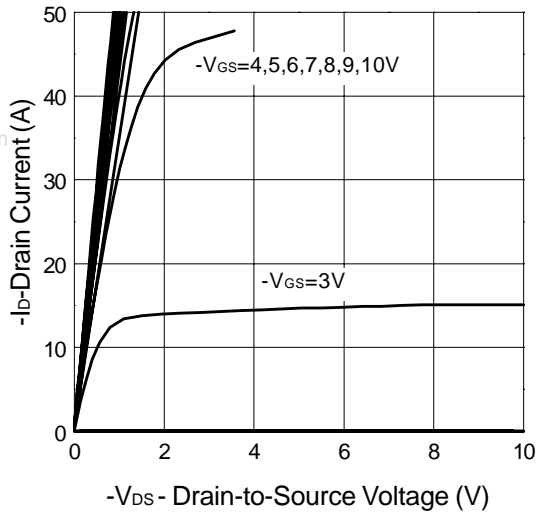

Transfer Characteristics

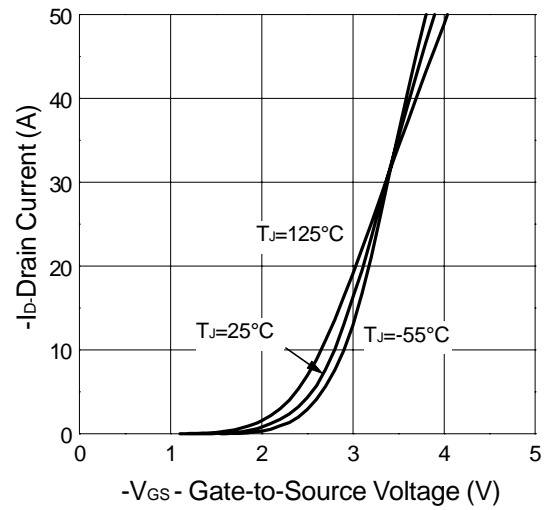

Threshold Voltage vs. Junction Temperature

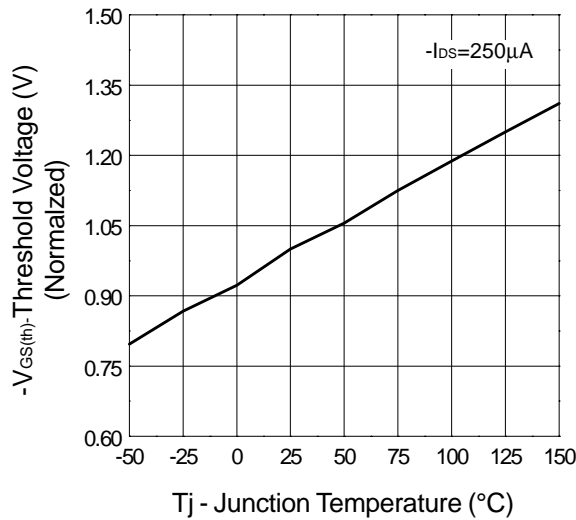

On-Resistance vs. Drain Current

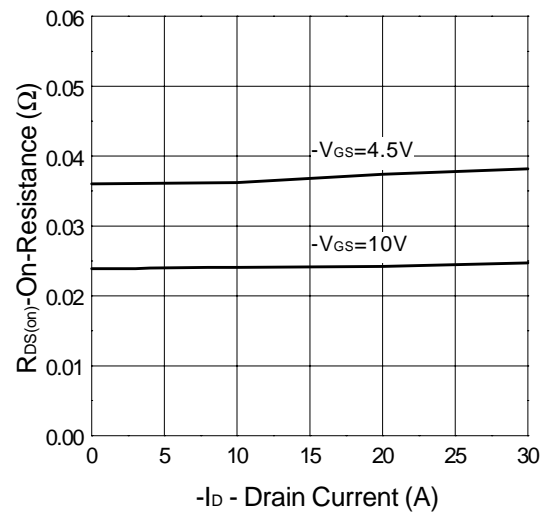

## Typical Characteristics

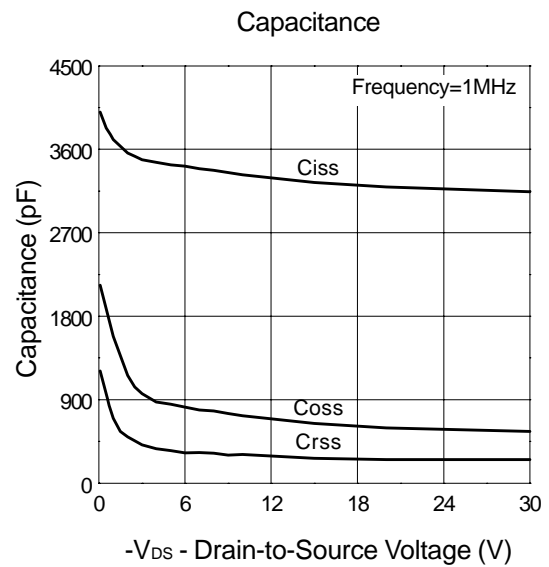
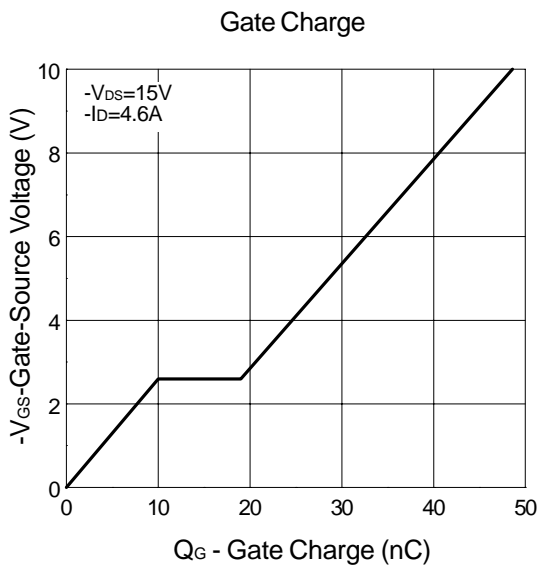
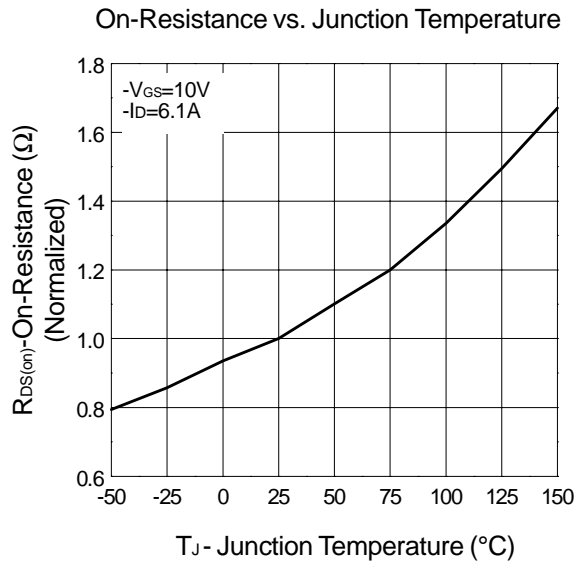
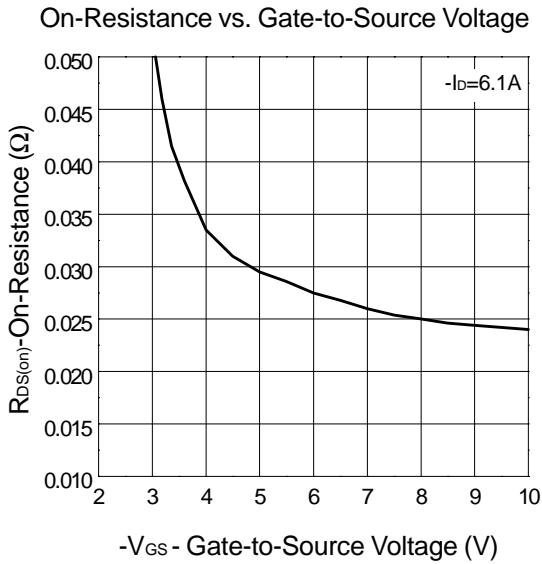

## Typical Characteristics

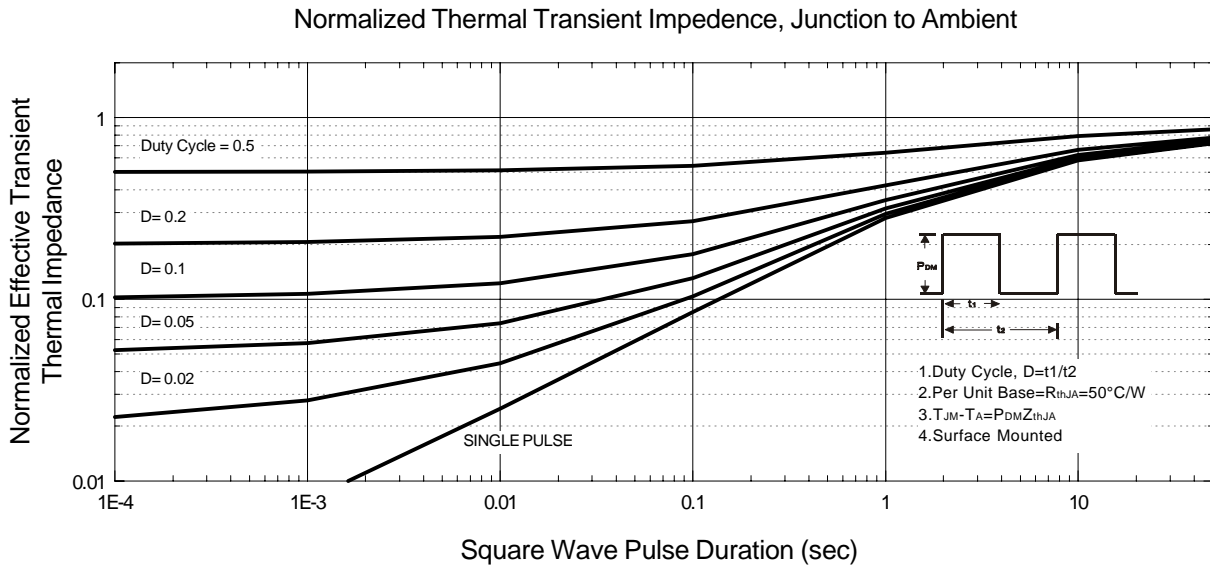
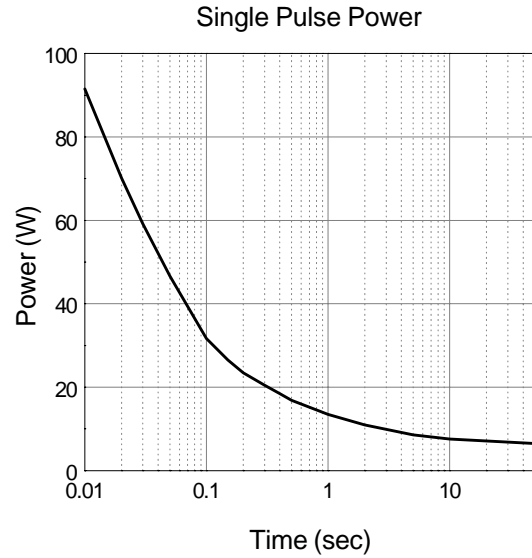
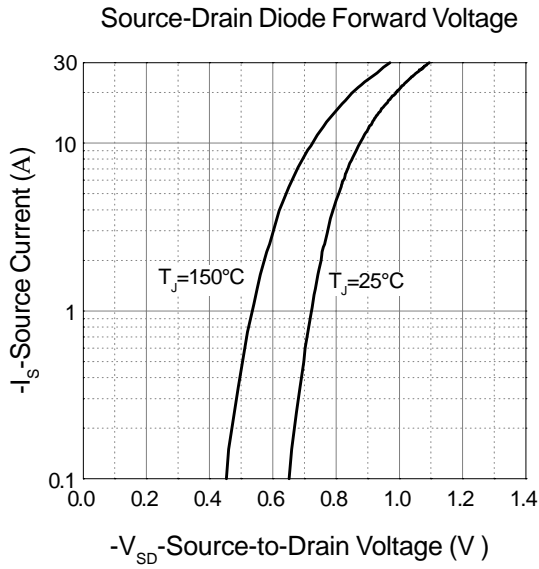

## Package Information

SOP-8 pin ( Reference JEDEC Registration MS-012)

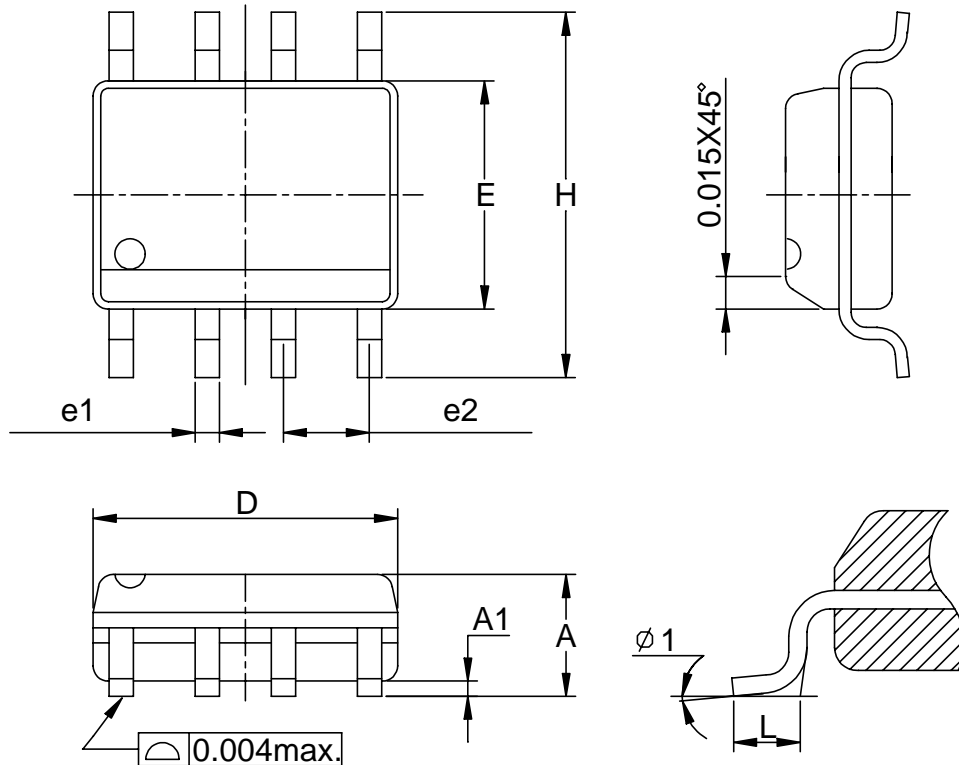

Dim	Millimeters		Inches	
	Min.	Max.	Min.	Max.
A	1.35	1.75	0.053	0.069
A1	0.10	0.25	0.004	0.010
D	4.80	5.00	0.189	0.197
E	3.80	4.00	0.150	0.157
H	5.80	6.20	0.228	0.244
L	0.40	1.27	0.016	0.050
e1	0.33	0.51	0.013	0.020
e2	1.27BSC		0.50BSC	
φ 1	8°		8°	

## Physical Specifications

Terminal Material	Solder-Plated Copper (Solder Material : 90/10 or 63/37 SnPb)
Lead Solderability	Meets EIA Specification RSI86-91, ANSI/J-STD-002 Category 3.
Packaging	2500 devices per reel for SOP-8

## Reflow Condition (IR/Convection or VPR Reflow)

Reference JEDEC Standard J-STD-020A APRIL 1999

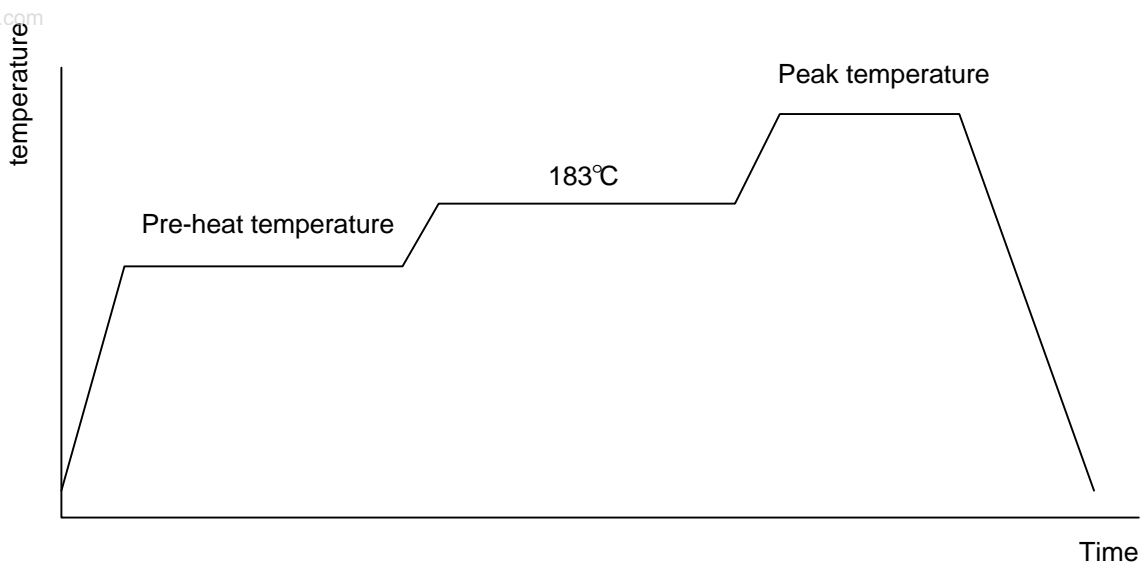

## Classification Reflow Profiles

	Convection or IR/ Convection	VPR
Average ramp-up rate(183°C to Peak)	3°C/second max.	10 °C /second max.
Preheat temperature 125 ± 25°C)	120 seconds max.	
Temperature maintained above 183°C	60 ~ 150 seconds	
Time within 5°C of actual peak temperature	10 ~ 20 seconds	60 seconds
Peak temperature range	220 +5/-0°C or 235 +5/-0°C	215~ 219°C or 235 +5/-0°C
Ramp-down rate	6 °C /second max.	10 °C /second max.
Time 25°C to peak temperature	6 minutes max.	

## Package Reflow Conditions

pkg. thickness ≥ 2.5mm and all bags	pkg. thickness < 2.5mm and pkg. volume ≥ 350 mm³	pkg. thickness < 2.5mm and pkg. volume < 350mm³
Convection 220 +5/-0 °C		Convection 235 +5/-0 °C
VPR 215-219 °C		VPR 235 +5/-0 °C
IR/Convection 220 +5/-0 °C		IR/Convection 235 +5/-0 °C

### Reliability test program

Test item	Method	Description
SOLDERABILITY	MIL-STD-883D-2003	245°C , 5 SEC
HOLT	MIL-STD-883D-1005.7	1000 Hrs Bias @ 125 °C
PCT	JESD-22-B, A102	168 Hrs, 100 % RH , 121°C
TST	MIL-STD-883D-1011.9	-65°C ~ 150°C, 200 Cycles
ESD	MIL-STD-883D-3015.7	VHBM > 2KV, VMM > 200V
Latch-Up	JESD 78	10ms , I <sub>tr</sub> > 100mA

### Carrier Tape

www.DataSheet4U.com

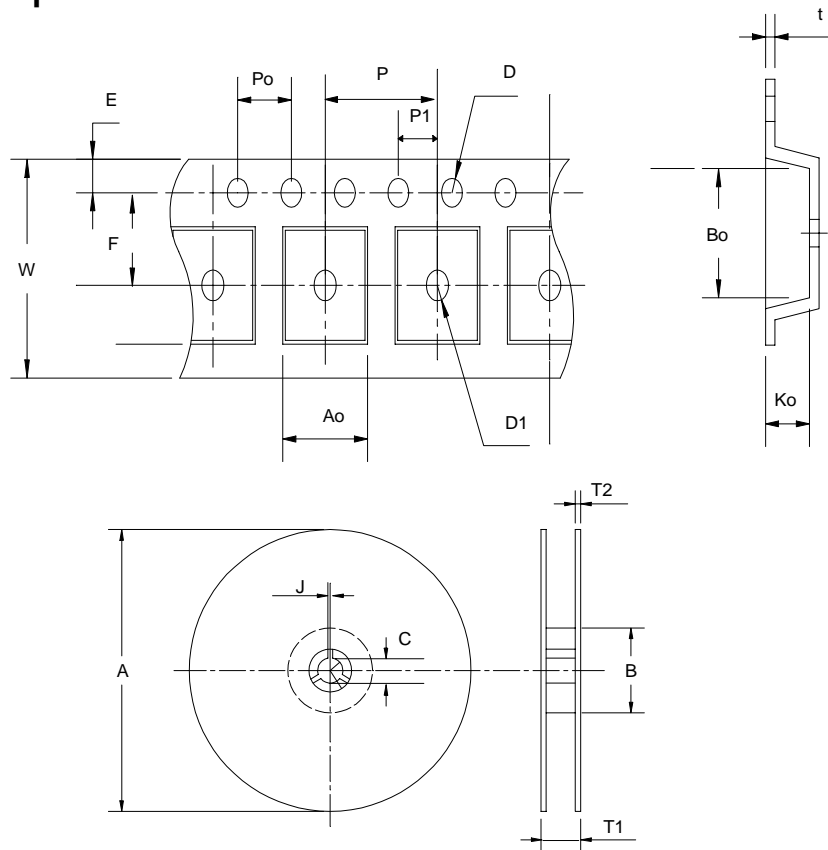

Application	A	B	C	J	T1	T2	W	P	E
SOP- 8	330 ± 1	62 +1.5	12.75+ 0.15	2 ± 0.5	12.4 ± 0.2	2 ± 0.2	12± 0.3	8± 0.1	1.75±0.1
	F	D	D1	Po	P1	Ao	Bo	Ko	t
	5.5± 1	1.55 +0.1	1.55+ 0.25	4.0 ± 0.1	2.0 ± 0.1	6.4 ± 0.1	5.2± 0.1	2.1± 0.1	0.3±0.013
	F	D	D1	Po	P1	Ao	Bo	Ko	t
	11.5 ± 0.1	1.5 +0.1	1.5+ 0.25	4.0 ± 0.1	2.0 ± 0.1	8.2 ± 0.1	13± 0.1	2.5± 0.1	0.35±0.013



## Cover Tape Dimensions

Carrier Width	12
Cover Tape Width	9.3

(mm)

## Customer Service

**Anpec Electronics Corp.**

Head Office :

5F, No. 2 Li-Hsin Road, SBIP,

Hsin-Chu, Taiwan, R.O.C.

Tel : 886-3-5642000

Fax : 886-3-5642050

Taipei Branch :

7F, No. 137, Lane 235, Pac Chiao Rd.,

Hsin Tien City, Taipei Hsien, Taiwan, R. O. C.

Tel : 886-2-89191368

Fax : 886-2-89191369