

Utilizing the latest Field Stop and Trench Gate technologies, these IGBT's have ultra low  $V_{CE(ON)}$  and are ideal for low frequency applications that require absolute minimum conduction loss. Easy paralleling is a result of very tight parameter distribution and a slightly positive  $V_{CE(ON)}$  temperature coefficient. Low gate charge simplifies gate drive design and minimizes losses.

- 1200V Field Stop
- Trench Gate: Low  $V_{CE(on)}$
- Easy Paralleling

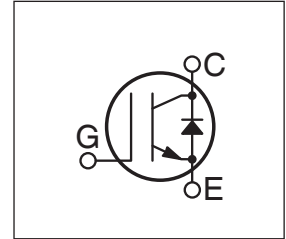
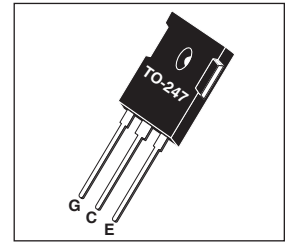

**Applications: Welding, Inductive Heating, Solar Inverters, SMPS, Motor drives, UPS**

### MAXIMUM RATINGS

All Ratings:  $T_C = 25^\circ\text{C}$  unless otherwise specified.

Symbol	Parameter	APT15GN120BDQ1(G)	UNIT
$V_{CES}$	Collector-Emitter Voltage	1200	Volts
$V_{GE}$	Gate-Emitter Voltage	$\pm 30$	
$I_{C1}$	Continuous Collector Current @ $T_C = 25^\circ\text{C}$	45	Amps
$I_{C2}$	Continuous Collector Current @ $T_C = 110^\circ\text{C}$	22	
$I_{CM}$	Pulsed Collector Current <sup>①</sup>	45	
SSOA	Switching Safe Operating Area @ $T_J = 150^\circ\text{C}$	45A @ 1200V	
$P_D$	Total Power Dissipation	195	Watts
$T_J, T_{STG}$	Operating and Storage Junction Temperature Range	-55 to 150	$^\circ\text{C}$
$T_L$	Max. Lead Temp. for Soldering: 0.063" from Case for 10 Sec.	300	

### STATIC ELECTRICAL CHARACTERISTICS

Symbol	Characteristic / Test Conditions	MIN	TYP	MAX	Units
$V_{(BR)CES}$	Collector-Emitter Breakdown Voltage ( $V_{GE} = 0V, I_C = 0.5mA$ )	1200			Volts
$V_{GE(TH)}$	Gate Threshold Voltage ( $V_{CE} = V_{GE}, I_C = 600\mu A, T_J = 25^\circ\text{C}$ )	5.0	5.8	6.5	
$V_{CE(ON)}$	Collector-Emitter On Voltage ( $V_{GE} = 15V, I_C = 15A, T_J = 25^\circ\text{C}$ )	1.4	1.7	2.1	
	Collector-Emitter On Voltage ( $V_{GE} = 15V, I_C = 15A, T_J = 125^\circ\text{C}$ )		2.0		
$I_{CES}$	Collector Cut-off Current ( $V_{CE} = 1200V, V_{GE} = 0V, T_J = 25^\circ\text{C}$ ) <sup>②</sup>			200	$\mu A$
	Collector Cut-off Current ( $V_{CE} = 1200V, V_{GE} = 0V, T_J = 125^\circ\text{C}$ ) <sup>②</sup>			TBD	
$I_{GES}$	Gate-Emitter Leakage Current ( $V_{GE} = \pm 20V$ )			120	nA
$R_{GINT}$	Intergrated Gate Resistor		N/A		$\Omega$



**CAUTION:** These Devices are Sensitive to Electrostatic Discharge. Proper Handling Procedures Should Be Followed.

## DYNAMIC CHARACTERISTICS

APT15GN120BDQ1(G)

Symbol	Characteristic	Test Conditions	MIN	TYP	MAX	UNIT	
$C_{ies}$	Input Capacitance	<b>Capacitance</b> $V_{GE} = 0V, V_{CE} = 25V$ $f = 1 \text{ MHz}$		1200		pF	
$C_{oes}$	Output Capacitance			65			
$C_{res}$	Reverse Transfer Capacitance			50			
$V_{GEP}$	Gate-to-Emitter Plateau Voltage	Gate Charge $V_{GE} = 15V$ $V_{CE} = 600V$ $I_C = 15A$		9.0		V	
$Q_g$	Total Gate Charge <sup>③</sup>			90			
$Q_{ge}$	Gate-Emitter Charge			5			
$Q_{gc}$	Gate-Collector ("Miller") Charge			55			
SSOA	Switching Safe Operating Area	$T_J = 150^\circ\text{C}, R_G = 4.3\Omega^{\text{⑦}}, V_{GE} = 15V, L = 100\mu\text{H}, V_{CE} = 1200V$	45			A	
$t_{d(on)}$	Turn-on Delay Time	<b>Inductive Switching (25°C)</b> $V_{CC} = 800V$ $V_{GE} = 15V$ $I_C = 15A$ $R_G = 4.3\Omega^{\text{⑦}}$ $T_J = +25^\circ\text{C}$		10		ns	
$t_r$	Current Rise Time			9			
$t_{d(off)}$	Turn-off Delay Time			150			
$t_f$	Current Fall Time			110			
$E_{on1}$	Turn-on Switching Energy <sup>④</sup>				410		μJ
$E_{on2}$	Turn-on Switching Energy (Diode) <sup>⑤</sup>				730		
$E_{off}$	Turn-off Switching Energy <sup>⑥</sup>				950		
$t_{d(on)}$	Turn-on Delay Time		<b>Inductive Switching (125°C)</b> $V_{CC} = 800V$ $V_{GE} = 15V$ $I_C = 15A$ $R_G = 4.3\Omega^{\text{⑦}}$ $T_J = +125^\circ\text{C}$		10		ns
$t_r$	Current Rise Time			9			
$t_{d(off)}$	Turn-off Delay Time			170			
$t_f$	Current Fall Time			185			
$E_{on1}$	Turn-on Switching Energy <sup>④</sup>				475		μJ
$E_{on2}$	Turn-on Switching Energy (Diode) <sup>⑤</sup>				1310		
$E_{off}$	Turn-off Switching Energy <sup>⑥</sup>				1300		

## THERMAL AND MECHANICAL CHARACTERISTICS

Symbol	Characteristic	MIN	TYP	MAX	UNIT
$R_{\theta JC}$	Junction to Case ( <b>IGBT</b> )			.64	°C/W
$R_{\theta JC}$	Junction to Case ( <b>DIODE</b> )			1.18	
$W_T$	Package Weight		5.9		gm

① Repetitive Rating: Pulse width limited by maximum junction temperature.

② For Combi devices,  $I_{ces}$  includes both IGBT and FRED leakages

③ See MIL-STD-750 Method 3471.

④  $E_{on1}$  is the clamped inductive turn-on energy of the IGBT only, without the effect of a commutating diode reverse recovery current adding to the IGBT turn-on loss. Tested in inductive switching test circuit shown in figure 21, but with a Silicon Carbide diode.

⑤  $E_{on2}$  is the clamped inductive turn-on energy that includes a commutating diode reverse recovery current in the IGBT turn-on switching loss. (See Figures 21, 22.)

⑥  $E_{off}$  is the clamped inductive turn-off energy measured in accordance with JEDEC standard JESD24-1. (See Figures 21, 23.)

⑦  $R_G$  is external gate resistance, not including  $R_{Gint}$  nor gate driver impedance. (MIC4452)

APT Reserves the right to change, without notice, the specifications and information contained herein.

**TYPICAL PERFORMANCE CURVES**

**APT15GN120BDQ1(G)**

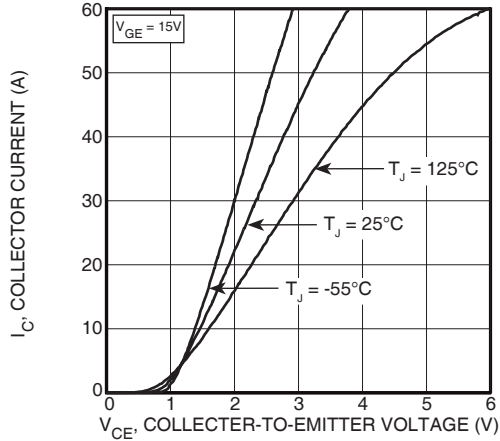

**FIGURE 1, Output Characteristics(T<sub>J</sub> = 25°C)**

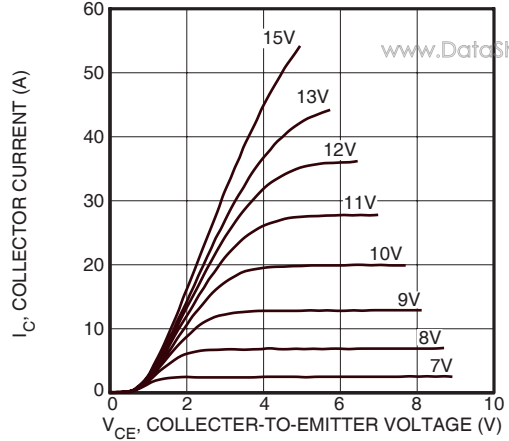

**FIGURE 2, Output Characteristics (T<sub>J</sub> = 125°C)**

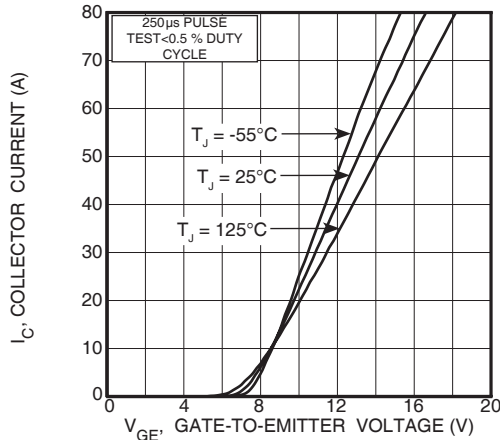

**FIGURE 3, Transfer Characteristics**

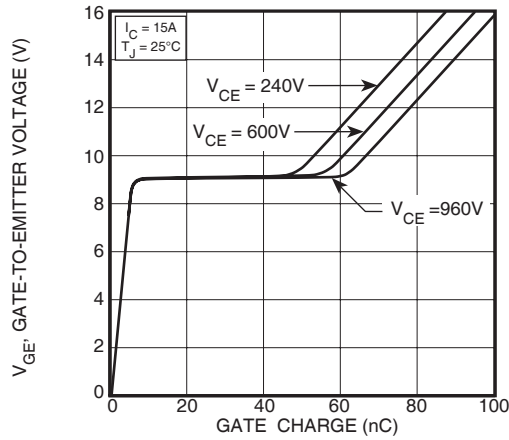

**FIGURE 4, Gate Charge**

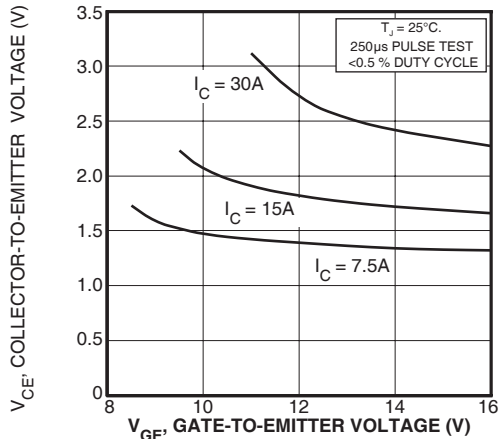

**FIGURE 5, On State Voltage vs Gate-to-Emitter Voltage**

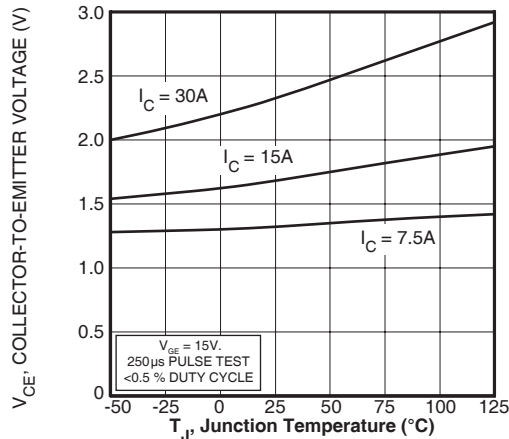

**FIGURE 6, On State Voltage vs Junction Temperature**

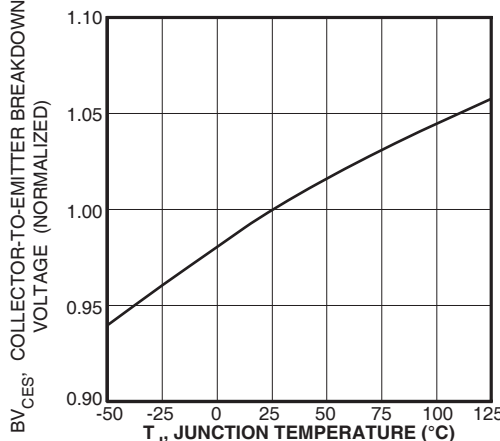

**FIGURE 7, Breakdown Voltage vs. Junction Temperature**

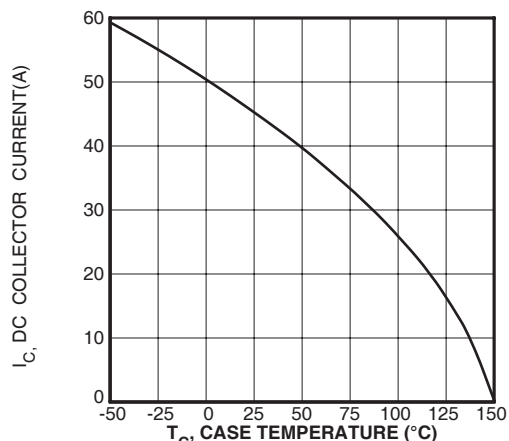

**FIGURE 8, DC Collector Current vs Case Temperature**

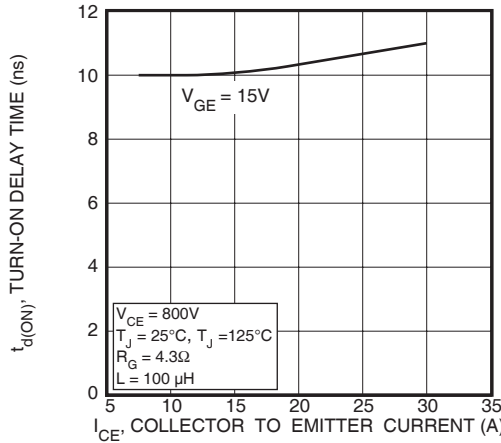

FIGURE 9, Turn-On Delay Time vs Collector Current

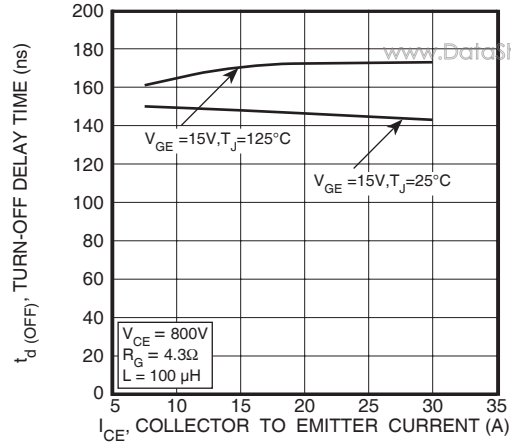

FIGURE 10, Turn-Off Delay Time vs Collector Current

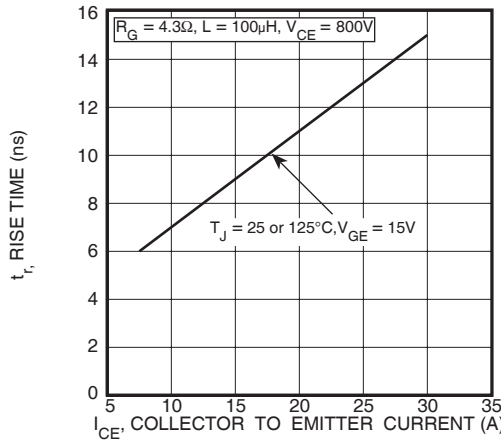

FIGURE 11, Current Rise Time vs Collector Current

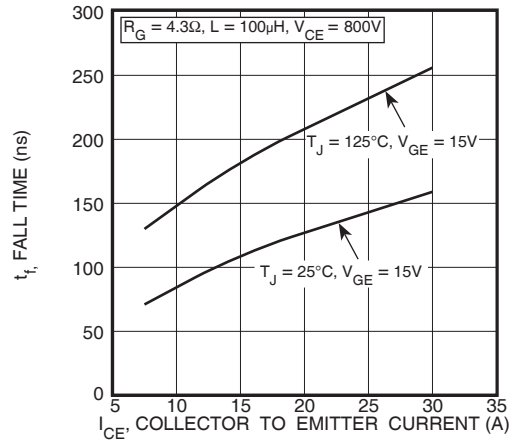

FIGURE 12, Current Fall Time vs Collector Current

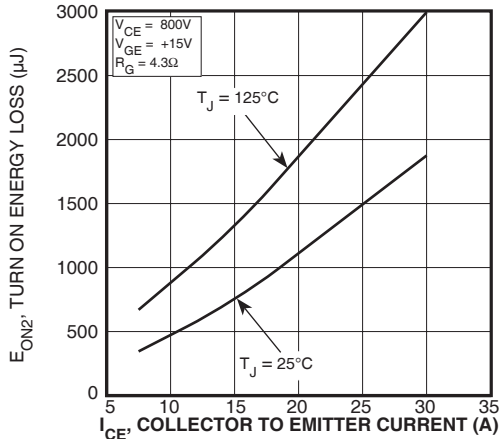

FIGURE 13, Turn-On Energy Loss vs Collector Current

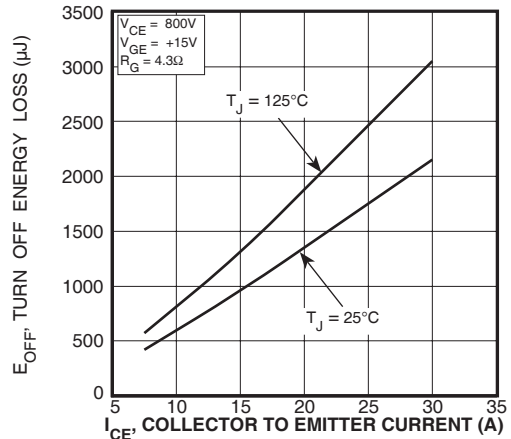

FIGURE 14, Turn Off Energy Loss vs Collector Current

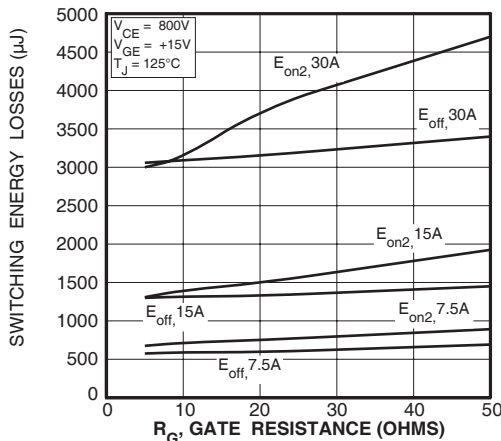

FIGURE 15, Switching Energy Losses vs. Gate Resistance

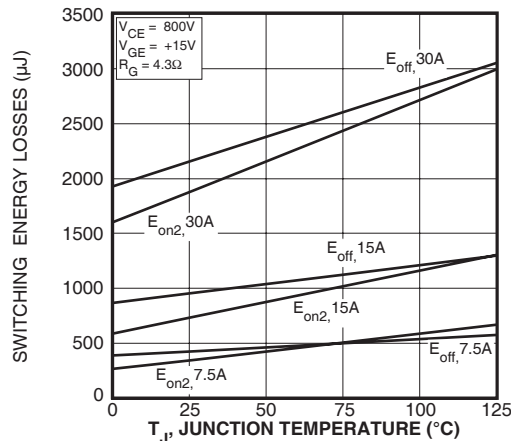

FIGURE 16, Switching Energy Losses vs Junction Temperature

### TYPICAL PERFORMANCE CURVES

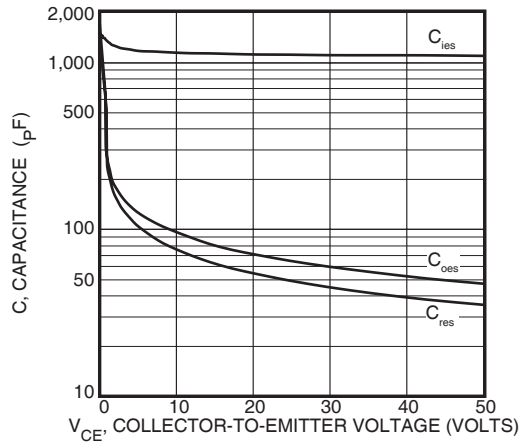

Figure 17, Capacitance vs Collector-To-Emitter Voltage

### APT15GN120BDQ1(G)

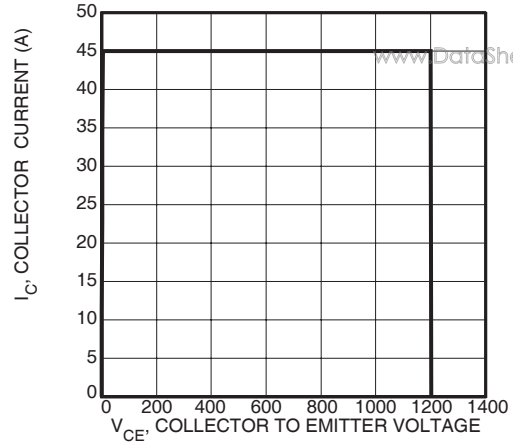

Figure 18, Minimum Switching Safe Operating Area

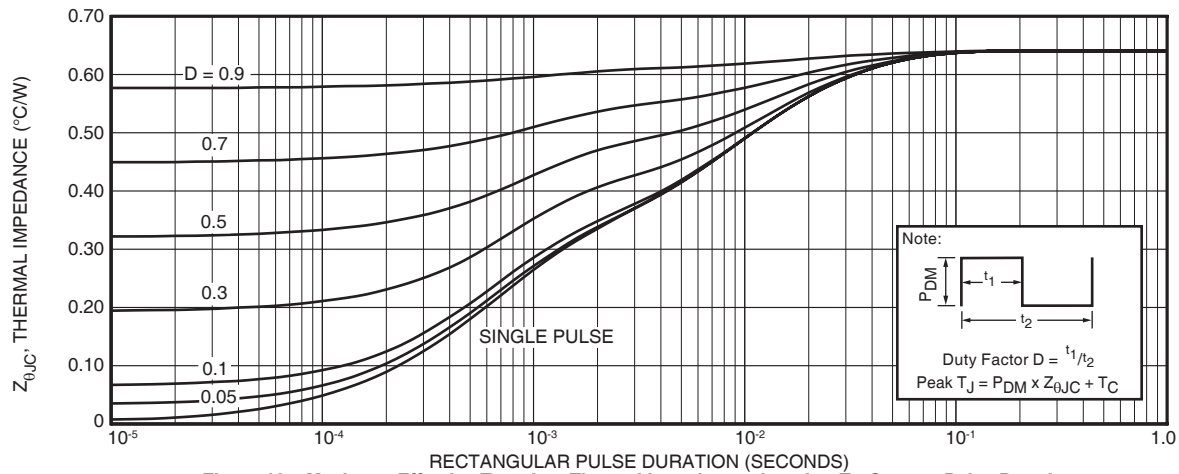

Figure 19a, Maximum Effective Transient Thermal Impedance, Junction-To-Case vs Pulse Duration

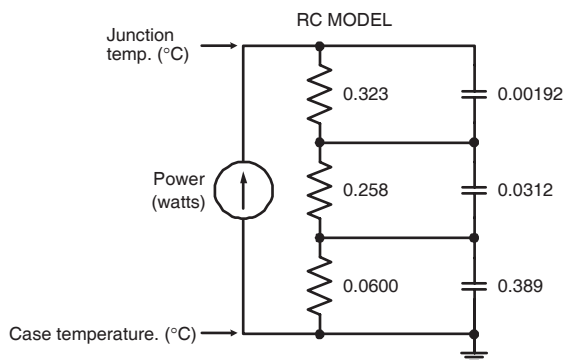

FIGURE 19b, TRANSIENT THERMAL IMPEDANCE MODEL

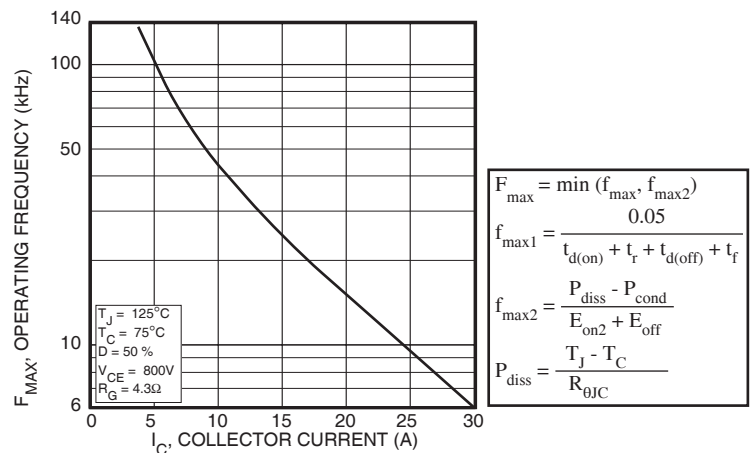

Figure 20, Operating Frequency vs Collector Current

$$F_{\max} = \min(f_{\max1}, f_{\max2})$$

$$f_{\max1} = \frac{0.05}{t_{d(\text{on})} + t_r + t_{d(\text{off})} + t_f}$$

$$f_{\max2} = \frac{P_{\text{diss}} - P_{\text{cond}}}{E_{\text{on2}} + E_{\text{off}}}$$

$$P_{\text{diss}} = \frac{T_J - T_C}{R_{\theta JC}}$$

# APT15GN120BDQ1(G)

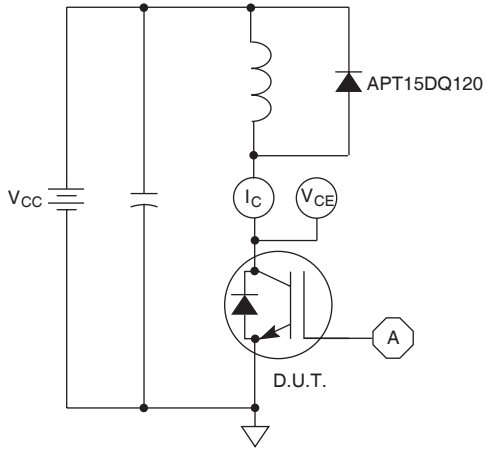

Figure 21, Inductive Switching Test Circuit

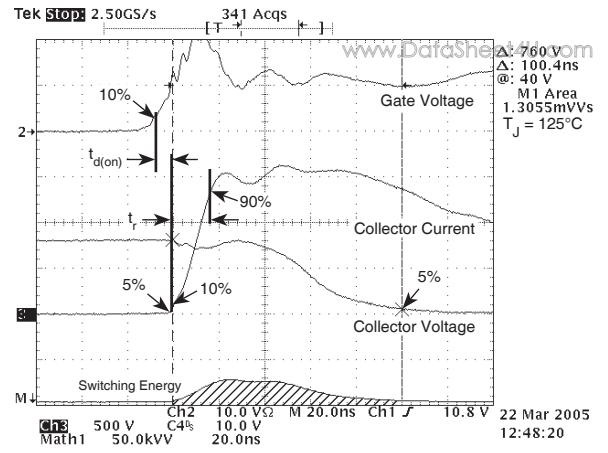

Figure 22, Turn-on Switching Waveforms and Definitions

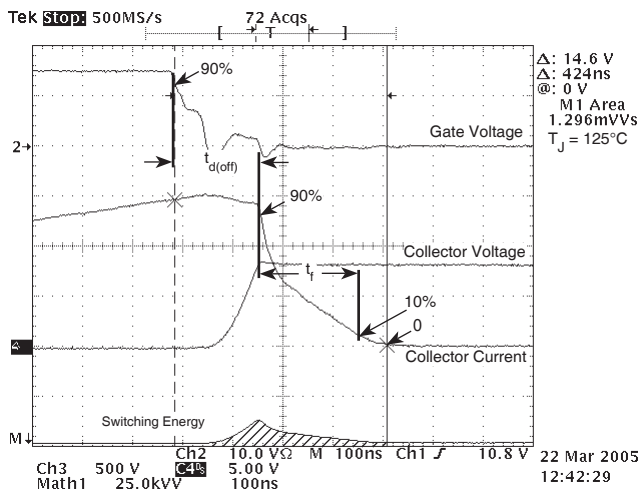

Figure 23, Turn-off Switching Waveforms and Definitions

# ULTRAFAST SOFT RECOVERY ANTI-PARALLEL DIODE

**MAXIMUM RATINGS**

All Ratings:  $T_C = 25^\circ\text{C}$  unless otherwise specified.

Symbol	Characteristic / Test Conditions	APT15GN120BDQ1(G)		UNIT
$I_F(AV)$	Maximum Average Forward Current ( $T_C = 127^\circ\text{C}$ , Duty Cycle = 0.5)	15		Amps
$I_F(RMS)$	RMS Forward Current (Square wave, 50% duty)	29		
$I_{FSM}$	Non-Repetitive Forward Surge Current ( $T_J = 45^\circ\text{C}$ , 8.3ms)	110		

**STATIC ELECTRICAL CHARACTERISTICS**

Symbol	Characteristic / Test Conditions	MIN	TYP	MAX	UNIT
$V_F$	Forward Voltage	$I_F = 15\text{A}$	2.8		Volts
		$I_F = 30\text{A}$	2.4		
		$I_F = 15\text{A}, T_J = 125^\circ\text{C}$	2.45		

**DYNAMIC CHARACTERISTICS**

Symbol	Characteristic	Test Conditions	MIN	TYP	MAX	UNIT
$t_{rr}$	Reverse Recovery Time	$I_F = 1\text{A}, di_F/dt = -100\text{A}/\mu\text{s}, V_R = 30\text{V}, T_J = 25^\circ\text{C}$	-	21		ns
$t_{rr}$	Reverse Recovery Time	$I_F = 15\text{A}, di_F/dt = -200\text{A}/\mu\text{s}, V_R = 800\text{V}, T_C = 25^\circ\text{C}$	-	240		
$Q_{rr}$	Reverse Recovery Charge		-	260		nC
$I_{RRM}$	Maximum Reverse Recovery Current		-	3	-	Amps
$t_{rr}$	Reverse Recovery Time	$I_F = 15\text{A}, di_F/dt = -200\text{A}/\mu\text{s}, V_R = 800\text{V}, T_C = 125^\circ\text{C}$	-	290		ns
$Q_{rr}$	Reverse Recovery Charge		-	960		nC
$I_{RRM}$	Maximum Reverse Recovery Current		-	6	-	Amps
$t_{rr}$	Reverse Recovery Time	$I_F = 15\text{A}, di_F/dt = -1000\text{A}/\mu\text{s}, V_R = 800\text{V}, T_C = 125^\circ\text{C}$	-	130		ns
$Q_{rr}$	Reverse Recovery Charge		-	1340		nC
$I_{RRM}$	Maximum Reverse Recovery Current		-	19		Amps

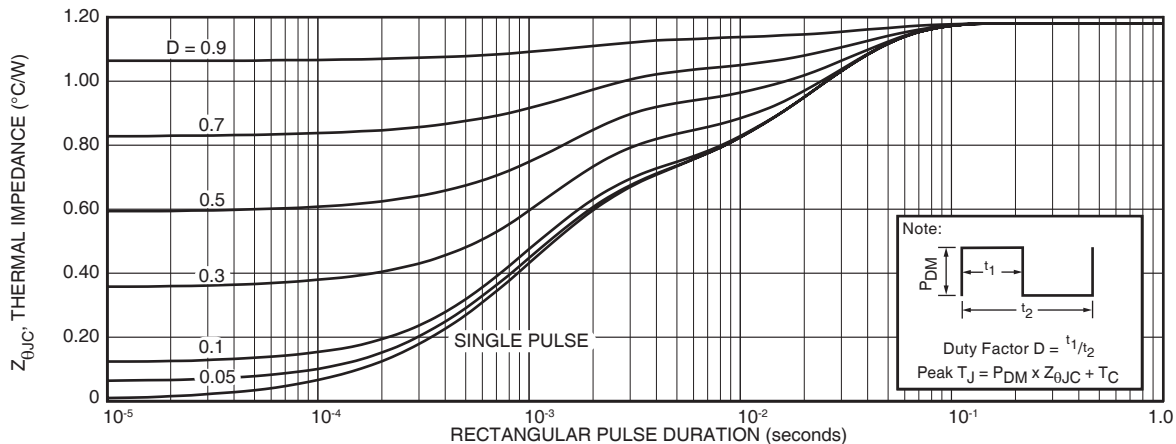

FIGURE 24a. MAXIMUM EFFECTIVE TRANSIENT THERMAL IMPEDANCE, JUNCTION-TO-CASE vs. PULSE DURATION

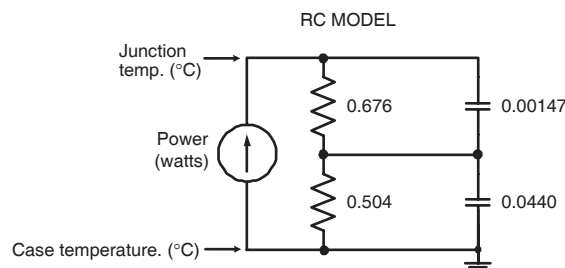

FIGURE 24b. TRANSIENT THERMAL IMPEDANCE MODEL

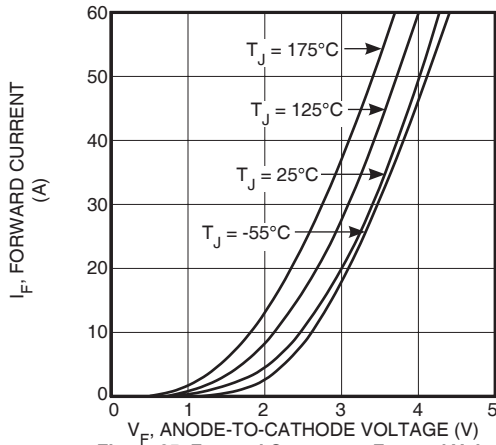

Figure 25. Forward Current vs. Forward Voltage

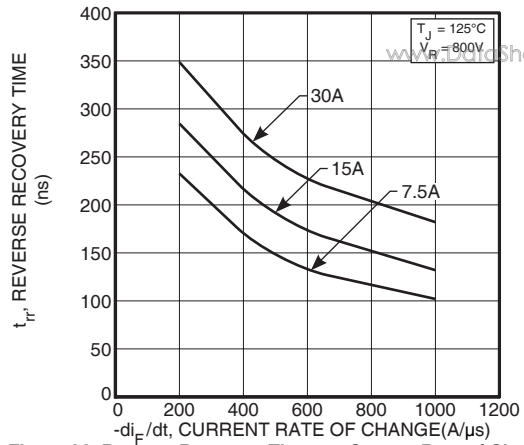

Figure 26. Reverse Recovery Time vs. Current Rate of Change

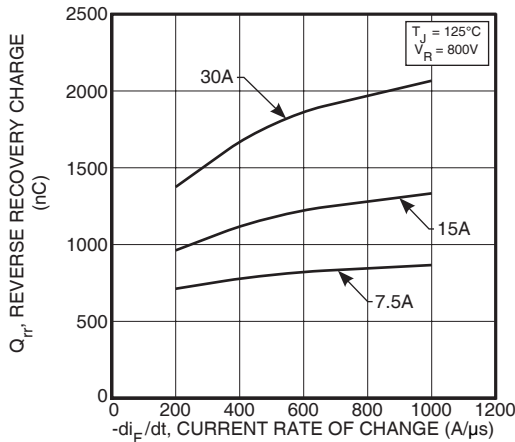

Figure 27. Reverse Recovery Charge vs. Current Rate of Change

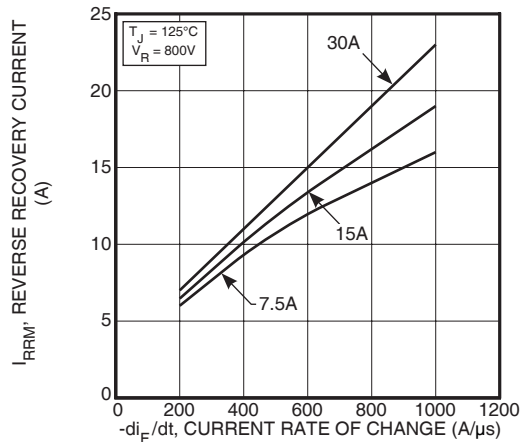

Figure 28. Reverse Recovery Current vs. Current Rate of Change

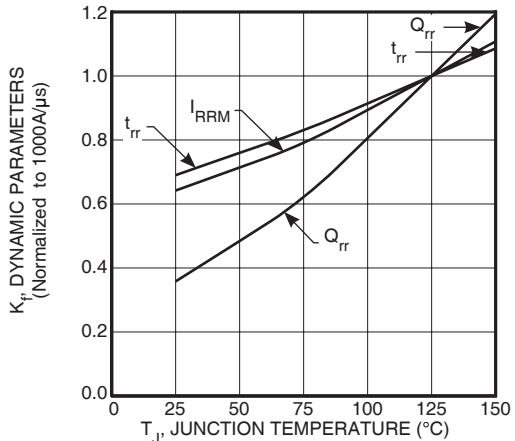

Figure 29. Dynamic Parameters vs. Junction Temperature

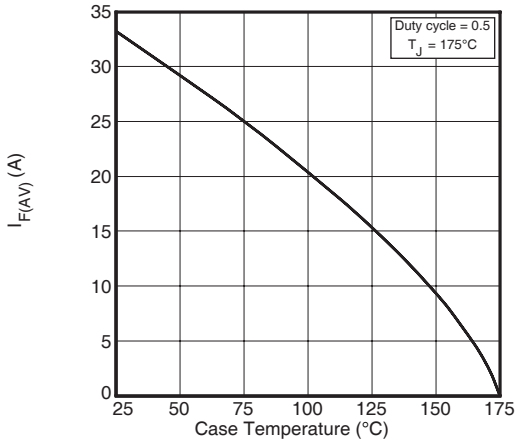

Figure 30. Maximum Average Forward Current vs. Case Temperature

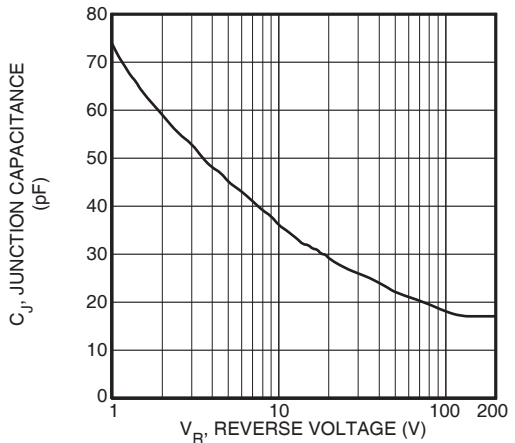

Figure 31. Junction Capacitance vs. Reverse Voltage



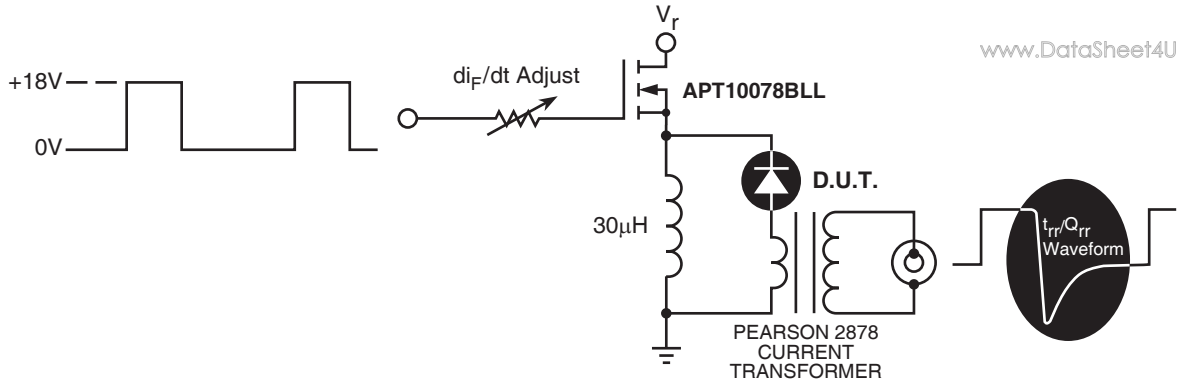

Figure 32. Diode Test Circuit

- 1  $I_F$  - Forward Conduction Current
- 2  $di_F/dt$  - Rate of Diode Current Change Through Zero Crossing.
- 3  $I_{RRM}$  - Maximum Reverse Recovery Current.
- 4  $t_{rr}$  - Reverse Recovery Time, measured from zero crossing where diode current goes from positive to negative, to the point at which the straight line through  $I_{RRM}$  and  $0.25 \cdot I_{RRM}$  passes through zero.
- 5  $Q_{rr}$  - Area Under the Curve Defined by  $I_{RRM}$  and  $t_{rr}$ .

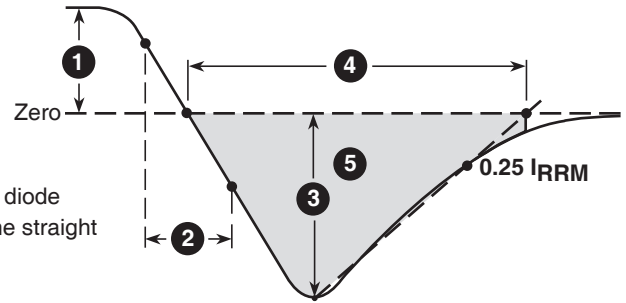
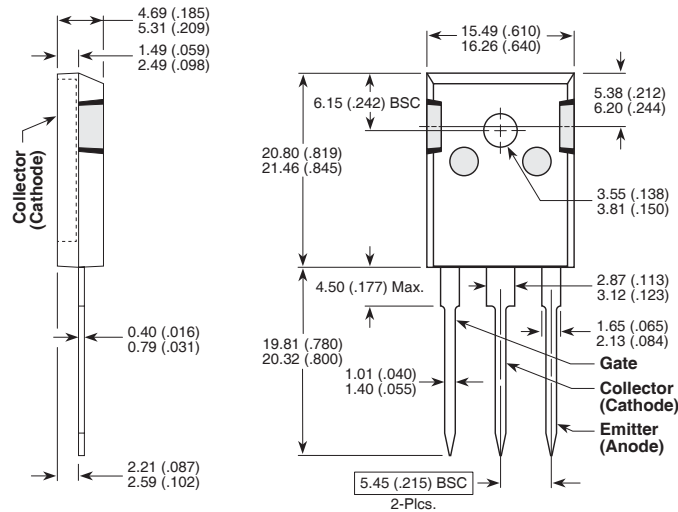

Figure 33, Diode Reverse Recovery Waveform and Definitions

### TO-247 Package Outline

(e1) SAC: Tin, Silver, Copper



Dimensions in Millimeters and (Inches)